

**WT1600**  
**Digital Power Meter**

**U S E R ' S M A N U A L**

---

# Product Registration

Thank you for purchasing YOKOGAWA products.

YOKOGAWA provides registered users with a variety of information and services.

Please allow us to serve you best by completing the product registration form accessible from our homepage.

<http://www.yokogawa.com/tm/>

---

Thank you for purchasing the YOKOGAWA WT1600 Digital Power Meter. This user's manual contains useful information about the functions, operating procedures, and handling precautions of the instrument. To ensure correct use, please read this manual thoroughly before beginning operation. After reading the manual, keep it in a convenient location for quick reference whenever a question arises during operation. The following two manuals, including this one, are provided as manuals for the WT1600. Read them along with this manual.

Manual Title	Manual No.	Description
WT1600 Digital Power Meter User's Manual	IM 760101-01E	This manual. Explains all functions and procedures of the WT1600 excluding the communication functions.
WT1600 Digital Power Meter Communication Interface User's Manual	IM 760101-11E	Explains the communication functions of the GP-IB, RS-232, and Ethernet interfaces.

## Notes

- The contents of this manual are subject to change without prior notice as a result of continuing improvements to the instrument's performance and functions. The figures given in this manual may differ from the actual screen.
- Every effort has been made in the preparation of this manual to ensure the accuracy of its contents. However, should you have any questions or find any errors, please contact your nearest YOKOGAWA dealer.
- Copying or reproducing all or any part of the contents of this manual without the permission of Yokogawa Electric Corporation is strictly prohibited.
- The TCP/IP software of this product and the document concerning the TCP/IP software have been developed/created by YOKOGAWA based on the BSD Networking Software, Release 1 that has been licensed from California University.

## Trademarks

- MS-DOS is either a registered trademark or trademark of Microsoft Corporation in the United States and/or other countries.
- Adobe, Adobe Acrobat, and PostScript are registered trademarks or trademarks of Adobe Systems Incorporated.
- Zip is either a registered trademark or trademark of Iomega Corporation in the United States and/or other countries.
- For purposes of this manual, the TM and ® symbols do not accompany their respective trademark names or registered trademark names.
- Other company and product names are trademarks or registered trademarks of their respective companies.

## Revisions

- First edition: June 2001
- Second edition: August 2001
- Third edition: December 2002
- Fourth edition: April 2004

# Checking the Contents of the Package

Unpack the box and check the contents before operating the instrument. If some of the contents are not correct or missing or if there is physical damage, contact the dealer from which you purchased them.

## WT1600

Check that the model name and suffix code given on the name plate on the side panel match those on the order.

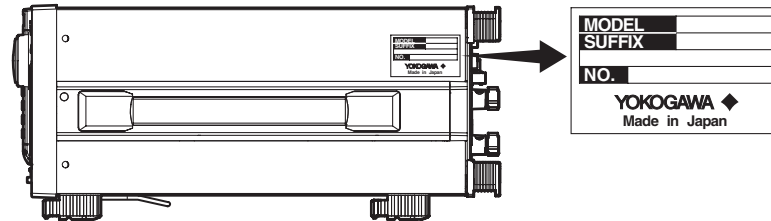

### MODEL and SUFFIX Codes

Model	Suffix Code	Description	
760101		100-120 / 200-240 VAC For details on the construction of the current input terminal that is equipped on the instrument, see the next section.	
Current input terminal Construction	Element	1    2    3    4    5    6	
	-01	50 A    –    –    –    –    –	
	-02	50 A    50 A    –    –    –    –	
	-03	50 A    50 A    50 A    –    –    –	
	-04	50 A    50 A    50 A    50 A    –    –	
	-05	50 A    50 A    50 A    50 A    50 A    –	
	-06	50 A    50 A    50 A    50 A    50 A    50 A	
	-10	5 A    –    –    –    –    –	
	-11	5 A    50 A    –    –    –    –	
	-12	5 A    50 A    50 A    –    –    –	
	-13	5 A    50 A    50 A    50 A    –    –	
	-14	5 A    50 A    50 A    50 A    50 A    –	
	-15	5 A    50 A    50 A    50 A    50 A    50 A	
	-20	5 A    5 A    –    –    –    –	
	-21	5 A    5 A    50 A    –    –    –	
	-22	5 A    5 A    50 A    50 A    –    –	
	-23	5 A    5 A    50 A    50 A    50 A    –	
	-24	5 A    5 A    50 A    50 A    50 A    50 A	
	-30	5 A    5 A    5 A    –    –    –	
	-31	5 A    5 A    5 A    50 A    –    –	
	-32	5 A    5 A    5 A    50 A    50 A    –	
	-33	5 A    5 A    5 A    50 A    50 A    50 A	
	-40	5 A    5 A    5 A    5 A    –    –	
	-41	5 A    5 A    5 A    5 A    50 A    –	
	-42	5 A    5 A    5 A    5 A    50 A    50 A	
	-50	5 A    5 A    5 A    5 A    5 A    –	
	-51	5 A    5 A    5 A    5 A    5 A    50 A	
	-60	5 A    5 A    5 A    5 A    5 A    5 A	
	Communication interface (Either one is built in.)	-C1	GP-IB Interface
		-C2	Serial (RS-232) interface

	<b>Suffix Code</b>	<b>Description</b>
Power cord	-D	UL/CSA Standard power cord (Part No.: A1006WD) [Maximum rated voltage: 125 V; Maximum rated current: 7 A]
	-F	VDE Standard Power Cord (Part No.: A1009WD) [Maximum rated voltage: 250 V; Maximum rated current: 10 A]
	-Q	BS Standard Power Cord (Part No.: A1054WD) [Maximum rated voltage: 250 V; Maximum rated current: 10 A]
	-R	AS Standard Power Cord (Part No.: A1024WD) [Maximum rated voltage: 240 V; Maximum rated current: 10 A]
Options	/B5	Built-in printer
	/C7	SCSI
	/C10	SCSI, Ethernet interface, and internal hard disk.
	/DA	D/A output (30 channels)
	/MTR	Motor evaluation function
		(Either /C7 or /C10 can be added)

**Example of specifications and suffix code**

Ex: 5-A input terminals in elements 1 through 3, 50-A input terminals in elements 4 through 6, GP-IB interface, UL/CSA standard power cord, built-in printer, and SCSI → 760101-33-C1-D/B5/C7

**NO. (Instrument No.)**

When contacting the dealer from which you purchased the instrument, please quote the instrument No.

## Checking the Contents of the Package

### Standard Accessories

The following are supplied with the instrument.

Part Name	Part Number	Q'ty	Notes
1. Power cord	See the previous table.	1	–
2. Spare power fuse	A1354EF	1	250 V, 6.3 A, time lag (attached to the fuse holder)
3. Printer roll paper	B9316FX	2	For the built-in printer Provided only with option /B5
4. Rubber feet	A9088ZM	2	Two pieces in one set. Two sets provided.
5. 36-pin connector	A1005JD	1	For D/A output Provided only with option /DA
6. Current input protective cover	B9316BX	1	With 4 attachment screws, part number B9946GZ.
7. • User's Manual	IM760101-01E	1	This manual
• Communication Interface User's Manual	IM760101-11E	1	–

1. (One of the following power cords is supplied according to the instrument's suffix codes.)

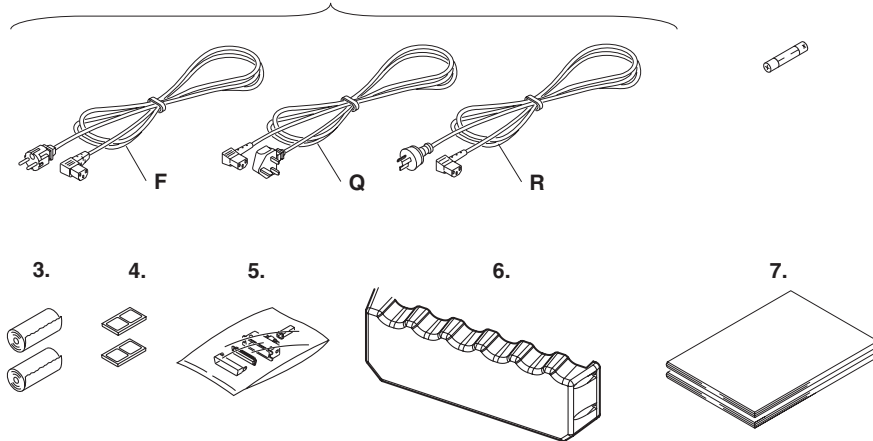

### Optional Accessories (Sold Separately)

The following optional accessories are available for purchase separately.

Part Name	Part Number	Q'ty	Notes
1. Serial port adapter	366971	1	9 pin <sup>*1</sup> -25 pin <sup>*2</sup> adapter *1 EIA-574 Standard *2 EIA-232 Standard (RS-232)
2. BNC-alligator clip	366926	1	42 V or less, length 1 m measurement lead
3. BNC-BNC measurement lead	366924 366925	1 1	42 V or less, length 1 m 42 V or less, length 2 m
4. External sensor cable	B9284LK	1	For connecting the current sensor input connector of the WT1600 Length 0.5 m
5. Measurement lead	758917	1	Two leads in one set, used with the separately sold 758922 or 758929 adapter, length 0.75 m, ratings 1000 V
6. Alligator clip adapter set	758922	1	Two pieces in one set, for the 758917 measurement lead. Rated voltage 300 V
7. Alligator clip adapter set	758929	1	Two pieces in one set, for the 758917 measurement lead. Rated voltage 1000 V
8. Fork terminal adapter set	758921	1	Two pieces in one set, for the 758917 measurement lead. Rated current 25 A

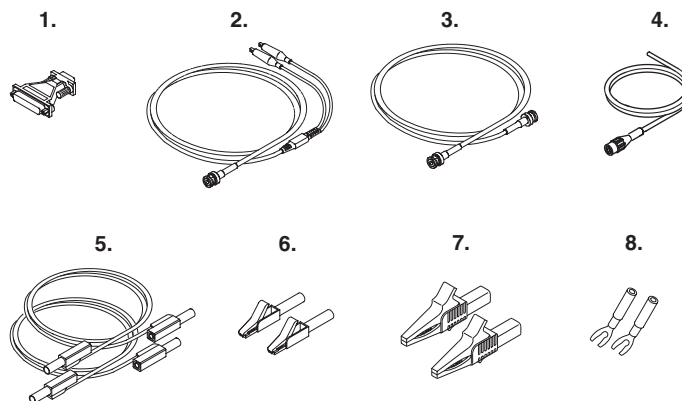

### Spare Parts (Sold Separately)

The following spare parts are available.

Part Name	Part Number	Q'ty	Notes
1. Printer roll paper	B9316FX	10	One roll is one set, thermal- sensitive paper, total length 10 m
2. Power fuse	A1354EF	2	250 V, 6.3 A, time lag









---

# Safety Precautions

This instrument is an IEC safety class I instrument (provided with terminal for protective earth grounding).

The general safety precautions described herein must be observed during all phases of operation. If the instrument is used in a manner not specified in this manual, the protection provided by the instrument may be impaired. Yokogawa Electric Corporation assumes no liability for the customer's failure to comply with these requirements.

## The following symbols are used on this instrument.

-  "Handle with care." (To avoid injury, death of personnel or damage to the instrument, the operator must refer to the explanation in the User's Manual or Service Manual.)
-  Electric shock, danger
-  Alternating current
-  Both direct and alternating current
-  ON(power)
-  OFF(power)
-  In-position of a bistable push control
-  Out-position of a bistable push control
-  Ground



---

**Make sure to comply with the precautions below. Not complying might result in injury or death.**

---

**WARNING**

**Power Supply**

Ensure that the source voltage matches the voltage of the power supply before turning ON the power.

**Power Cord and Plug**

To prevent the possibility of electric shock or fire, be sure to use the power cord supplied by YOKOGAWA. The main power plug must be plugged into an outlet with a protective earth terminal. Do not invalidate this protection by using an extension cord without protective earth grounding.

**Protective Grounding**

Make sure to connect the protective earth to prevent electric shock before turning ON the power.

**Necessity of Protective Grounding**

Never cut off the internal or external protective earth wire or disconnect the wiring of the protective earth terminal. Doing so poses a potential shock hazard.

**Defect of Protective Grounding**

Do not operate the instrument if the protective earth or fuse might be defective. Also, make sure to check them before operation.

**Fuse**

To avoid the possibility of fire, only use a fuse that has a rating (voltage, current, and type) that is specified by the instrument. When replacing a fuse, turn OFF the power switch and unplug the power cord. Never short the fuse holder.

**Do Not Operate in an Explosive Atmosphere**

Do not operate the instrument in the presence of flammable liquids or vapors. Operation in such environments constitutes a safety hazard.

**Do Not Remove Covers**

The cover should be removed by YOKOGAWA's qualified personnel only. Opening the cover is dangerous, because some areas inside the instrument have high voltages.

**External Connection**

Securely connect the protective grounding before connecting to the item under measurement or an external control unit.

---

---

# How to Use This Manual

## Structure of the Manual

This user's manual consists of the following sections.

---

### **Chapter 1 Explanation of Functions**

Describes the functions of the instrument. Operating procedures are not given in this chapter. However, reading this chapter will help you understand the operating procedures given in the chapters that follow.

---

### **Chapter 2 Names and Uses of Parts**

Describes the names and uses of each part of the instrument.

---

### **Chapter 3 Before Starting Measurements**

Describes precautions for the use of the instrument, how to install the instrument, how to connect to the power supply, how to wire measurement circuits, how to turn ON/OFF the power switch, and other preparations before starting measurements.

---

### **Chapter 4 Screen Display Format**

Describes how to display numerical data, waveforms, bar graphs, vectors, and trends, the mixed display, and the meaning of each displayed item.

---

### **Chapter 5 Measurement Conditions**

Describes how to set the input conditions for the measured voltage/current signal and the handling of the input signal such as the wiring system, the measurement range, the filter, averaging, data update rate, and the crest factor.

---

### **Chapter 6 Normal Measurement and Integration**

Describes how to set the displayed items of numerical data during normal measurement, how to set the computing equation, and how to set integration.

---

### **Chapter 7 Harmonic Measurement**

Describes how to set the displayed item of numerical data, the PLL source, the order of analysis, the computing equation, the bar graph, and the vector display during harmonic measurement.

---

### **Chapter 8 Motor Evaluation (Option)**

Describes how to set the instrument in order to determine the motor characteristics by inputting signals from revolution sensors and torque meters.

---

### **Chapter 9 Waveform Display**

Describes how to display the waveforms of the voltage and current signals.

---

### **Chapter 10 Trend Display**

Describes how to display the trend.

---

### **Chapter 11 Storing and Recalling Data and Saving the Stored Data**

Describes how to store and recall the data and how to save the stored data.

---

### **Chapter 12 Saving and Loading the Data**

Describes how to save setup parameters, waveform display data, numerical data, and screen image data and how to load the saved data to the instrument.

---

### **Chapter 13 Ethernet Communications (Option)**

Describes how to mutually transfer files containing setup parameters, waveform display data, and numerical data with PCs and workstations that are on the network using the Ethernet interface.

---

### **Chapter 14 Built-in Printer (Option)**

Describes how to output numerical data and screen image to the built-in printer.

---

### **Chapter 15 D/A Output and Other Functions**

Describes how to set the D/A output and other functions.

---

### **Chapter 16 Troubleshooting, Maintenance, and Inspection**

Describes the possible causes of problems and their appropriate corrective measures. Describes the messages that are displayed on the screen. Describes maintenance and inspection issues such as how to perform self-tests and replace power fuses.

---

### **Chapter 17 Specifications**

Summarizes the specifications of the instrument in tables.

---

### **Appendix**

Describes how to determine the measurement function and delta computation. Gives a list of initial settings. Describes the ASCII header file format.

---

### **Index**

Alphabetic and symbol index of contents.

---

## Conventions Used in This Manual

### Unit

k: Denotes 1000. Example: 15 kg, 100 kHz

K: Denotes 1024. Example: 640 KB (Storage capacity of floppy disks)

### Displayed Characters

Bold characters used in the procedural explanations indicate characters that are displayed on the panel keys for the respective procedure or the characters on the screen.

SHIFT+key means you will press SHIFT to turn ON the indicator that is located above and to the left of SHIFT followed by the operation key. The menu written below the pressed key appears on the screen.

### Symbols

The following symbols are used in this manual.



*Improper handling or use can lead to injury to the user or damage to the instrument.* This symbol appears on the instrument to indicate that the user must refer to the user's manual for special instructions. The same symbol appears in the corresponding place in the user's manual to identify those instructions. In the manual, the symbol is used in conjunction with the word "WARNING" or "CAUTION."

### **WARNING**

Describes precautions that should be observed to prevent injury or death to the user.

### **CAUTION**

Describes precautions that should be observed to prevent minor or moderate injury, or damage to the instrument.

### **Note**

Provides important information for the proper operation of the instrument.

## Symbols Used on Pages Describing Operating Procedures

On pages that describe the operating procedures in Chapter 3 through 16, the following symbols are used to distinguish the procedures from their explanations.

### **Keys**

Indicates the key related to the operation.

### **Procedure**

Follow the steps indicated with numbers. The procedures are given with the premise that the user is carrying out the steps for the first time. Depending on the operation, not all steps need to be taken.

### **Explanation**

This section describes the setup parameters and the limitations regarding the procedures. It does not give a detailed explanation of the function. For details on the function, see chapter 1.

---

# Contents

Checking the Contents of the Package .....	ii
Safety Precautions .....	vi
How to Use This Manual .....	viii

## Chapter 1 Explanation of Functions

1.1 System Configuration and Block Diagram .....	1-1
1.2 Measurement Function and Measurement Period .....	1-3
1.3 Measurement Conditions .....	1-9
1.4 Numeric Display .....	1-14
1.5 Computation .....	1-18
1.6 Integration .....	1-20
1.7 Waveform Display .....	1-23
1.8 Bar Graphs, Vectors, and Trend Displays .....	1-29
1.9 Saving and Loading Data and Other Functions .....	1-32

## Chapter 2 Names and Uses of Parts

2.1 Front Panel, Rear Panel, and Top View .....	2-1
2.2 Operation Keys, Jog Shuttle .....	2-3

## Chapter 3 Before Starting Measurements

3.1 Precautions Concerning the Use of the Instrument .....	3-1
3.2 Installing the Instrument .....	3-2
△ 3.3 Wiring Precautions .....	3-4
3.4 For Making Accurate Measurements .....	3-6
△ 3.5 Connecting the Power Supply .....	3-8
3.6 Directly Wiring the Circuit under Measurement .....	3-9
3.7 Using an External Current Sensor to Wire the Circuit under Measurement .....	3-12
3.8 Using an External PT or CT to Wire the Circuit under Measurement .....	3-16
△ 3.9 Wiring a Circuit with Voltage Input Exceeding 600 V .....	3-19
3.10 Turning ON/OFF the Power Switch .....	3-20
3.11 Setting the Date and Time .....	3-22
3.12 Entering Values and Strings .....	3-24

## Chapter 4 Screen Display Format

4.1 Displaying the Data (Numerical Data) of Measurement Functions .....	4-1
4.2 Displaying Waveforms .....	4-10
4.3 Displaying Bar Graphs .....	4-12
4.4 Displaying Vectors .....	4-14
4.5 Displaying Trends .....	4-15
4.6 Listing the Setup Parameters .....	4-17

## Chapter 5 Measurement Conditions

5.1 Selecting the Wiring System .....	5-1
5.2 Setting the Measurement Range during Direct Input .....	5-4
5.3 Setting the Measurement Range When Using an External Current Sensor .....	5-10
5.4 Setting the Scaling Function When Using an External PT or CT .....	5-14
5.5 Selecting the Input Filter .....	5-17
5.6 Averaging .....	5-19
5.7 Changing the Data Update Rate .....	5-22

5.8	Holding the Display and Performing Single Measurements .....	5-24
5.9	Holding the Numerical Data Display at the Maximum .....	5-25
△ 5.10	Performing Master/Slave Synchronized Measurements .....	5-26
5.11	Selecting the Crest Factor .....	5-29

## Chapter 6 Normal Measurement and Integration

6.1	Changing the Displayed Item of Numerical Data .....	6-1
6.2	Setting the Measurement Period .....	6-4
6.3	Selecting the Frequency Measurement Target .....	6-7
6.4	Setting the User-Defined Function .....	6-8
6.5	Setting the Delta Computation .....	6-12
6.6	Setting the Equations for Apparent Power and Corrected Power .....	6-15
6.7	Selecting the Display Format of the Phase Difference .....	6-18
6.8	Setting the Normal Integration Mode and the Integration Timer .....	6-20
6.9	Setting the Real-time Integration Mode, the Integration Timer, and the Reservation Time .....	6-23
6.10	Selecting the Current Mode for Current Integration and ON/OFF of Integration Auto Calibration .....	6-29
6.11	Performing Integration (Start, Stop, and Reset) .....	6-31

## Chapter 7 Harmonic Measurement

7.1	Setting the Harmonic Measurement Mode .....	7-1
7.2	Changing the Displayed Item of Numerical Data .....	7-2
7.3	Selecting the Measurement Target .....	7-7
△ 7.4	Selecting the PLL Source .....	7-8
7.5	Setting the Harmonic Order to Be Analyzed .....	7-11
7.6	Selecting the Equation for the Distortion Factor .....	7-13
7.7	Changing the Data Length .....	7-14
7.8	Setting the User-Defined Function .....	7-15
7.9	Changing the Display Items of Bar Graphs and Performing Cursor Measurements .....	7-19
7.10	Changing the Vector Display .....	7-23

## Chapter 8 Motor Evaluation (Option)

△ 8.1	Inputting Signals of Rotating Speed and Torque .....	8-1
8.2	Selecting the Input Range of the Revolution and Torque Signals and the Synchronization Source .....	8-3
8.3	Selecting the Line Filter .....	8-6
8.4	Setting the Scaling Factor, the Pulse Count, and Unit Used to Measure the Rotating Speed .....	8-7
8.5	Setting the Scaling Factor and Unit Used to Measure the Torque .....	8-10
8.6	Setting the Motor's Number of Poles Used to Compute the Synchronous Speed and the Slip .....	8-12
8.7	Setting the Scaling Factor and Unit Used to Compute the Motor Output .....	8-14
8.8	Computing the Motor Efficiency and Total Efficiency .....	8-16

## Chapter 9 Waveform Display

9.1	Retrieving Waveform Display Data .....	9-1
9.2	Setting the Time Axis .....	9-2
△ 9.3	Setting the Trigger .....	9-4
9.4	Zooming Vertically and Moving the Vertical Position .....	9-8
9.5	Turning ON/OFF the Waveform Display .....	9-11
9.6	Splitting the Screen and Displaying Waveforms .....	9-13

9.7	Interpolating the Display and Changing the Graticule .....	9-16
9.8	Turning ON/OFF the Scale Value and Waveform Label .....	9-19
9.9	Performing Cursor Measurements .....	9-21

## Chapter 10 Trend Display

10.1	Retrieving Trend Display Data .....	10-1
10.2	Selecting the Trend Display Target .....	10-2
10.3	Turning ON/OFF the Trend Display .....	10-6
10.4	Splitting the Screen and Displaying Trends .....	10-8
10.5	Setting the Time Axis .....	10-10
10.6	Setting the Scale .....	10-12
10.7	Performing Cursor Measurements .....	10-14
10.8	Restarting the Trend .....	10-18

## Chapter 11 Storing and Recalling Data and Saving the Stored Data

11.1	Setting the Store Mode .....	11-1
11.2	Setting the Store Count, the Store Interval, and the Store Reservation Time .....	11-3
11.3	Setting the Numerical Data and Waveform Display Data to Be Stored .....	11-6
11.4	Storing the Data .....	11-10
11.5	Saving the Stored Data .....	11-13
11.6	Recalling the Stored Data .....	11-20

## Chapter 12 Saving and Loading the Data

12.1	Precautions to Be Taken When Using the Floppy Disk Drive .....	12-1
12.2	Built-in Hard Disk (Option) .....	12-2
12.3	Connecting a SCSI Device .....	12-3
12.4	Changing the SCSI ID Number .....	12-4
12.5	Formatting the Disk .....	12-6
12.6	Saving Setup Parameters, Waveform Display Data, and Numerical Data .....	12-11
12.7	Saving Screen Image Data .....	12-20
12.8	Loading Setup Parameters .....	12-23
12.9	Specifying the File to Be Displayed, Viewing File Properties, and Changing the File Attribute .....	12-26
12.10	Deleting Files .....	12-29
12.11	Copying Files .....	12-32
12.12	Renaming Directories and Files and Creating Directories .....	12-36

## Chapter 13 Ethernet Communications (Option)

13.1	Connecting the WT1600 to a PC .....	13-1
13.2	Setting the Ethernet Interface (TCP/IP) .....	13-2
13.3	Saving Setup, Waveform Display, Numerical, and Image Data to the FTP Server (FTP Client Function) .....	13-8
13.4	Outputting the Screen Image to a Network Printer .....	13-11
13.5	Sending E-mail Messages .....	13-15
13.6	Accessing the WT1600 from a PC or Workstation (FTP Server Function) .....	13-19
13.7	Checking the Presence of the Ethernet Interface (Option) and the MAC address .....	13-23
13.8	Setting the FTP Passive Mode and LPR/SMTP Timeout .....	13-24

## Chapter 14 Built-in Printer (Option)

14.1	Installing the Paper Roll and Paper Feeding .....	14-1
14.2	Printing Screen Images .....	14-5
14.3	Printing Numerical Data Lists and Bar Graphs .....	14-7

**Chapter 15 D/A Output and Other Functions**

△ 15.1 Setting the D/A Output (Option) ..... 15-1  
 15.2 RGB Video Signal (VGA) Output ..... 15-9  
 15.3 Initializing the Settings ..... 15-10  
 15.4 Performing Zero-Level Compensation ..... 15-12  
 15.5 Using the NULL Function ..... 15-13  
 15.6 Selecting the Message Language and the Screen Brightness ..... 15-14  
 15.7 Setting the Display Color of the Screen ..... 15-16  
 15.8 Setting Key Lock ..... 15-19

**Chapter 16 Troubleshooting, Maintenance, and Inspection**

16.1 Troubleshooting ..... 16-1  
 16.2 Error Messages and Corrective Actions ..... 16-2  
 16.3 Performing a Self-Test ..... 16-6  
 16.4 Checking the System Conditions ..... 16-8  
 △ 16.5 Replacing the Power Fuse ..... 16-9  
 16.6 Recommended Replacement Parts ..... 16-10

**Chapter 17 Specifications**

17.1 Input ..... 17-1  
 17.2 Display ..... 17-2  
 17.3 Measurement Functions (Items) during Normal Measurement ..... 17-3  
 17.4 Measurement Functions (Items) during Harmonic Measurement ..... 17-5  
 17.5 Accuracy ..... 17-7  
 17.6 Functions ..... 17-10  
 17.7 Input/Output of the Master/Slave Synchronization Signal ..... 17-16  
 17.8 External Clock Input ..... 17-16  
 17.9 RGB Video Signal (VGA) Output ..... 17-17  
 17.10 Built-in Floppy Disk ..... 17-17  
 17.11 Built-in Hard Disk (Option) ..... 17-17  
 17.12 SCSI (Option) ..... 17-17  
 17.13 Ethernet Interface (Option) ..... 17-18  
 17.14 Built-in Printer (Option) ..... 17-18  
 17.15 GP-IB Interface ..... 17-18  
 17.16 Serial (RS-232) Interface ..... 17-19  
 17.17 General Specifications ..... 17-19  
 17.18 External Dimensions ..... 17-21

**Appendix**

Appendix 1 Symbols and Determination of Measurement Functions ..... App-1  
 Appendix 2 Determination of Delta Computation ..... App-6  
 Appendix 3 List of Initial Settings and Display Order of Numerical Data ..... App-8  
 Appendix 4 ASCII Header File Format ..... App-14  
 Appendix 5 Power Basics  
 (Power/Harmonics/Three Constants Related to the AC Circuit) ..... App-17

**Index**



# 1.1 System Configuration and Block Diagram

## System Configuration

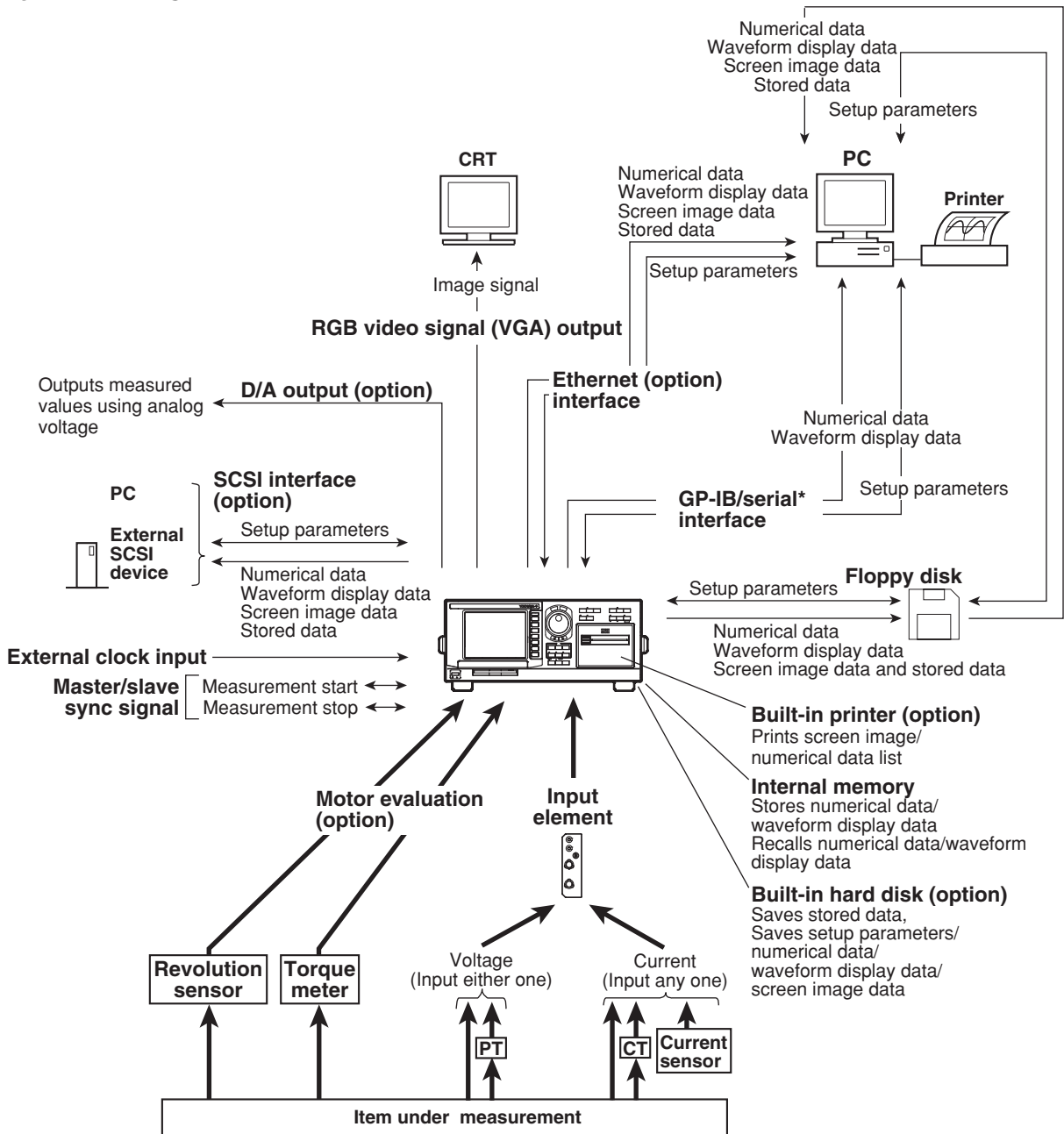

\* Conforms to EIA-574 (9-pin EIA-232(RS-232)).



## 1.1 System Configuration and Block Diagram

### Block Diagram

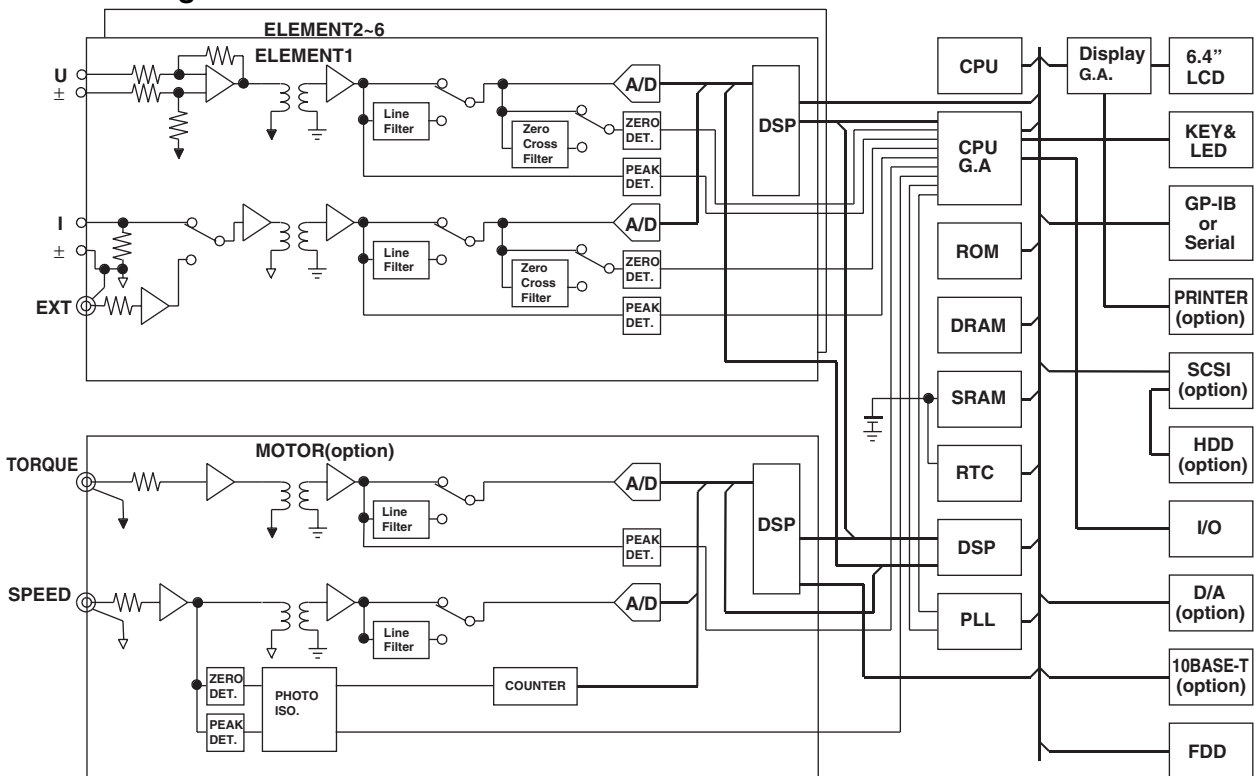

### Signal Flow and Process

The input circuits, Elements 1 through 6, consist of a voltage input circuit and a current input circuit. The input circuits are mutually isolated. They are also isolated from the case.

The voltage signal that is applied to the voltage input terminal ( $U, \pm$ ) is normalized using the voltage divider of the voltage input circuit and an operational amplifier (OP AMP). It is then isolated by the transformer and input to a voltage A/D converter.

The current input circuit is equipped with two types of input terminals, a current input terminal ( $I, \pm$ ) and a current sensor input connector (EXT). Either one can be used at any given time. The voltage signal from the current sensor that received the signal at the current sensor input connector is normalized using the voltage divider and an operational amplifier (OP AMP). It is then isolated by the transformer and input to a current A/D converter. The current signal that is applied to the current input terminal is converted to a voltage by a current divider. Then, it is input to the current A/D converter in the same fashion as the voltage signal from the current sensor.

During normal measurement, the voltage signal that is input to the voltage A/D converter or current A/D converter is converted to digital values at an interval of approximately  $5 \mu\text{s}$ .

The measured value is derived using a DSP based on the converted digital values.

During harmonic measurement, the applied voltage signal is converted to digital values at an interval that is an integer multiple of the PLL source signal (cycle of the clock generated by the PLL circuit). The measured value of each item of harmonic measurement is derived by performing an FFT based on the converted digital values using a DSP.

The measured value is transmitted to the CPU. Various computed values are determined from the measured values. These measured values and computed values are displayed, output through a D/A output, or output through communications.

When waveform display data is not being retrieved during normal measurement, the DSP and CPU processes are pipelined, and the DSP process is executed in real-time.

Therefore, measurements with few data dropouts can be achieved against the input signal.

## 1.2 Measurement Function and Measurement Period

### Types of Measurement Functions during Normal Measurement

The data (numerical data) of measurement functions during normal measurement is measured or computed from the sampled data<sup>\*1</sup> described later in “Measurement Period.”

<sup>\*1</sup> The WT1600 samples the instantaneous values of the voltage and current signals at a specified sample rate<sup>\*2</sup>. The sampled data is processed as numerical data or data used to display waveforms on the screen (waveform display data).

<sup>\*2</sup> Sample rate represents the number of data points that are sampled within 1 s. For example, at a sample rate of 200 kS/s, 200000 data points are sampled every second.

- **Types of Measurement Functions**

- **Measurement functions on each input element**

The following 29 types of measurement functions are available. For details on the determination of each measurement function data, see appendix 1.

U (voltage Urms, Umn, Udc, Uac), I (current Irms, Imn, Idc, Iac), P (active power), S (apparent power), Q (reactive power),  $\lambda$  (power factor),  $\phi$  (phase difference), fU/fl (also expressed as fU: FreqU and fl: FreqI, measures the frequencies of up to three voltage/current signals), U+pk/U-pk (maximum/minimum values of voltage), I+pk/I-pk (maximum/minimum values of current), CfU/Cfl (crest factor of voltage/current), FfU/Ffl (form factor of voltage/current), Z (impedance of the load circuit), Rs/Xs (resistance/reactance of the load circuit that has a resistor R, inductor L, and capacitor C connected in series), Rp/Xp (resistance/reactance of the load circuit that has a R, L, and C connected in parallel), Pc (Corrected Power)

- **Measurement functions of the average or sum of input elements ( $\Sigma$  functions)**

The following 19 types of measurement functions are available. For details on the determination of each measurement function data, see appendix 1.

U $\Sigma$  (voltage average Urms $\Sigma$ , Umn $\Sigma$ , Udc $\Sigma$ , Uac $\Sigma$ ), I $\Sigma$  (current average Irms $\Sigma$ , Imn $\Sigma$ , Idc $\Sigma$ , Iac $\Sigma$ ), P $\Sigma$  (sum of active powers), S $\Sigma$  (sum of apparent powers), Q $\Sigma$  (sum of reactive powers),  $\lambda\Sigma$  (power factor average),  $\phi\Sigma$  (phase difference average), Z $\Sigma$  (impedance average of the load circuit), Rs $\Sigma$ /Xs $\Sigma$  (average of the resistance/reactance of the load circuit that has a R, L, and C connected in series), Rp $\Sigma$ /Xp $\Sigma$  (average of the resistance/reactance of the load circuit that has a R, L, and C connected in parallel), Pc $\Sigma$  (sum of Corrected Powers)

- **Efficiency ( $\Sigma$  functions)**

$\eta$  (Efficiency 1),  $1/\eta$  (Efficiency 2). See “Efficiency” on the next page.

- **Measurement functions of integration**

See section 1.6.

**Determining the Voltage and Current**

There are four types of measurement functions for voltage (U) and current (I).

- **Urms, Irms (true rms value)**

These values are the true rms values of the voltage and current. The instantaneous values over one period are squared and averaged. Then, the square root of the value is determined.  $f(t)$  and  $T$  represent the input signal as a function of time and the period of the input signal, respectively.

$$U_{rms} \text{ or } I_{rms} = \sqrt{\frac{1}{T} \int_0^T f(t)^2 dt}$$

- **Umn, Imn (rectified mean value calibrated to the rms value)**

This function rectifies one period of the voltage or current signal, determines the average, and multiplies the result by a coefficient. The coefficient is a value that when applied to a sinusoidal input signal, gives the true rms value. When the input signal is a distorted or is a DC waveform, these values will differ from the true rms values.  $f(t)$  and  $T$  represent the input signal as a function of time and the period of the input signal, respectively.

$$U_{mn} \text{ or } I_{mn} = \frac{\pi}{2\sqrt{2}} \cdot \frac{1}{T} \int_0^T |f(t)| dt$$

- **Udc, Idc (simple average)**

These are the average values over one period of the voltage and current signal. This function is useful when determining the average value of a DC input signal or a DC component that is superimposed on an AC input signal.

$$U_{dc} \text{ or } I_{dc} = \frac{1}{T} \int_0^T f(t) dt$$

- **Uac, Iac (AC component)**

These are the AC components of the voltage and current. They are the square root values of the difference of the square of the true rms values of the input signal and the square of the DC component.

$$U_{ac} = \sqrt{U_{rms}^2 - U_{dc}^2} \text{ or } I_{ac} = \sqrt{I_{rms}^2 - I_{dc}^2}$$

**Element**

Element refers to a set of input terminals that can input a single phase of voltage and current to be measured. The WT1600 can contain up to six elements, which are numbered from 1 to 6. The element number is appended to the symbols that were defined in the earlier section, "Measurement functions on each input element" so that the correspondence between the numerical data and the element can be seen. For example, "Urms1" represents the true rms value of the voltage of element 1.

**Wiring System**

The selectable patterns of wiring systems vary depending on the number of input elements that are installed in the instrument. You may be able to select only a single type of wiring system or two or three types of wiring systems. When two or more types of wiring systems are selected, "A", "B", or "C" is appended to the symbols that were defined in the earlier section "Measurement functions of the average or sum of input elements ( $\Sigma$  functions)" so that the correspondence between the numerical data and the wiring unit can be seen. For example, "Urms $\Sigma$ A" represents the true rms value of the average of the voltage of the input elements that are assigned to wiring unit  $\Sigma$ A

**Efficiency**

$\eta$  (efficiency 1) is determined by the equation  $(P_{\Sigma B}) / (P_{\Sigma A}) \times 100$ ;  $1/\eta$  (efficiency 2) is determined by the equation  $(P_{\Sigma A}) / (P_{\Sigma B}) \times 100$ . You can create an equation using user-defined functions to determine efficiencies other than the above two. In addition, on models with the motor evaluation function (option),  $\eta mA((P_m) / (P_{\Sigma A}) \times 100)$  and  $\eta mB((P_m) / (P_{\Sigma B}) \times 100)$  can be determined.

## Types of Measurement Functions during Harmonic Measurement

The data (numerical data) of measurement functions during harmonic measurement is measured or computed from the sampled data<sup>\*1</sup> described later in "Measurement Period."

\* See the description of the sampled data in the earlier section "Types of Measurement Functions during Normal Measurement."

### Types of Harmonic Measurement Functions

- **Harmonic measurement functions on each input element**

The following 28 types of harmonic measurement functions are available. For details on the determination of each measurement function data, see appendix 1.

Measurement Function	Chars and Numbers inside ( )			All (No ( ))
	dc	1	k	
U( )	Yes	Yes	Yes	Yes
I( )	Yes	Yes	Yes	Yes
P( )	Yes	Yes	Yes	Yes
S( )	Yes	Yes	Yes	Yes
Q( )	Always 0	Yes	Yes	Yes
$\lambda$ ( )	Yes	Yes	Yes	Yes
$\phi$ ( )	No	Yes	Yes	Yes
$\phi$ U( )	No	No	Yes	No
$\phi$ I( )	No	No	Yes	No
Z( )	Yes	Yes	Yes	No
Rs( )	Yes	Yes	Yes	No
Xs( )	Yes	Yes	Yes	No
Rp( )	Yes	Yes	Yes	No
Xp( )	Yes	Yes	Yes	No
Uhdf( )	Yes	Yes	Yes	No
Ihdf( )	Yes	Yes	Yes	No
Phdf( )	Yes	Yes	Yes	No
Uthd	No	No	No	Yes
Ithd	No	No	No	Yes
Pthd	No	No	No	Yes
Uthf	No	No	No	Yes
Ithf	No	No	No	Yes
Utif	No	No	No	Yes
Itif	No	No	No	Yes
hvf	No	No	No	Yes
hcf	No	No	No	Yes
fU	No	No	No	Yes
fl	No	No	No	Yes

Yes: Numerical data exists

No: Numerical data does not exist

- The meaning of measurement functions with parentheses varies depending on the characters or numbers that are inside the parentheses as follows:
  - dc: Indicates numerical data of the DC component.
  - 1: Indicates numerical data of the fundamental signal.
  - k: Indicates numerical data from 2<sup>nd</sup> to N<sup>th</sup> order harmonics. N is the upper limit of harmonic order under analysis (see section 17.6). The upper limit is determined automatically (maximum is 100) by the frequency of the PLL source.
- All: No parentheses are appended after the measurement function. Indicates numerical data related to all waveforms including the fundamental and harmonics.
- Uhdf to hcf are measurement functions that indicate characteristics specific to the harmonics. For details on the determination of the measurement functions, see appendix 1.
- The frequency of up to three signals including the signals selected for the PLL source as fU (FreqU: voltage frequency) or fl (FreqI: current frequency) can be measured.

**1.2 Measurement Function and Measurement Period**

- **Harmonic measurement function that indicates the phase difference ( $\phi$ ) of the voltage and current between the input elements**

There are five harmonic measurement functions that express the phase difference ( $\phi$ ).

Explanation is given below for the case when the number of installed input elements is 5, the wiring system pattern is three-phase, four-wire for  $\Sigma A$  and three-phase, three-wire for  $\Sigma B$ .

When the target of the harmonic measurement is set to wiring unit  $\Sigma A$ , the target elements are 1, 2, and 3. The numerical data of the harmonic measurement functions of phase difference concerning elements 1, 2, and 3 can be determined as shown below.

When the target of the harmonic measurement is set to wiring unit  $\Sigma B$ , the target elements are 4 and 5. The numerical data of the harmonic measurement functions of phase difference concerning elements 4 and 5 ( $\phi U4-U5$ ,  $\phi U4-I4$  and  $\phi U4-I5$ ) can be determined. The phase difference  $\phi U4-U6$  and  $\phi U4-I6$  cannot be determined.

- $\phi U1-U2$   
Phase difference of the fundamental voltage  $U2(1)$  of element 2 with respect to the fundamental voltage  $U1(1)$  of element 1.
- $\phi U1-U3$   
Phase difference of the fundamental voltage  $U3(1)$  of element 3 with respect to the fundamental voltage  $U1(1)$  of element 1.
- $\phi U1-I1$   
Phase difference of the fundamental current  $I1(1)$  of element 1 with respect to the fundamental voltage  $U1(1)$  of element 1.
- $\phi U1-I2$   
Phase difference of the fundamental current  $I2(1)$  of element 2 with respect to the fundamental voltage  $U1(1)$  of element 1.
- $\phi U1-I3$   
Phase difference of the fundamental current  $I3(1)$  of element 3 with respect to the fundamental voltage  $U1(1)$  of element 1.

- **Harmonic measurement function of the average or of the sum of the input elements ( $\Sigma$  functions)**

The following 6 types of harmonic measurement functions are available. For details on the determination of each measurement function, see appendix 1.

Measurement Function	Chars and Numbers inside ( )	All (No ( ))
	1	
$U\Sigma( )$	Yes	Yes
$I\Sigma( )$	Yes	Yes
$P\Sigma( )$	Yes	Yes
$S\Sigma( )$	Yes	Yes
$Q\Sigma( )$	Yes	Yes
$\lambda\Sigma( )$	Yes	Yes

Yes: Numerical data exists

- For measurement functions with parentheses, the value "1" is entered in the parentheses. This represents the numerical data of the fundamental signal.
- All: No parentheses are appended after the measurement function. Indicates numerical data related to all waveforms including the fundamental and harmonics.

**Element**

Element refers to a set of input terminals that can input a single phase of voltage and current to be measured. The WT1600 can contain up to six elements, which are numbered from 1 to 6. The element number is appended to the symbols that were defined in the earlier section, “Harmonic measurement functions on each input element” so that the correspondence between the numerical data and the element can be seen. For example, “U1(2)” represents the voltage of the 2<sup>nd</sup> order harmonic of element 1.

**Wiring System**

The selectable patterns of wiring systems vary depending on the number of input elements that are installed in the instrument. You may be able to select only a single type of wiring system or two or three types of wiring systems. When two or more types of wiring systems are selected, “A”, “B”, or “C” is appended to the symbols that were defined in the earlier section “Harmonic measurement functions of the average or sum of input elements ( $\Sigma$  functions)” so that the correspondence between the numerical data and the wiring unit can be seen.

For example, “U $\Sigma$ A(1)” represents the average of the voltage of the fundamental signal of the input elements that are assigned to wiring unit  $\Sigma$ A.

**PLL Source «For procedures, see section 7.4»**

When measuring harmonics, the fundamental period (period of the fundamental signal) must be determined in order to analyze the higher orders. The PLL (phase locked loop) source is the signal that is used to determine the fundamental period. Selecting a signal with little distortion or fluctuation for the PLL source will result in a stable harmonic measurement. An ideal signal would be a rectangular wave with amplitude that is greater than or equal to 50% or 100% of the measurement range (see section 1.3) when the crest factor (see section 5.11) is set to 3 or 6, respectively. In addition, a sampling clock signal (Smp Clk) with a frequency that is 2048 times the fundamental frequency of the waveform on which to perform harmonic measurements can be input to the external clock input connector. Stable harmonic measurement is achieved by using this sampling clock to sample data from the target waveform. Stable harmonic measurement can also be achieved by applying a clock signal (Ext Clk) that has the same period as the waveform on which to perform harmonic measurements.

**Types of Measurement Functions of the Motor Evaluation Function (Option)**

By using the motor evaluation function (option), the rotating speed, torque, and output of a motor can be determined from the DC voltage (analog signal) or pulse count signal received from a revolution sensor, which is proportional to the rotating speed of the motor, and the DC voltage (analog signal) received from a torque meter, which is proportional to the motor’s torque. In addition, the synchronous speed and slip of a motor can be determined by setting the motor’s number of poles. Furthermore, the active power and frequency that are measured by the WT1600 and the motor output can be used to compute the motor efficiency and the total efficiency.

**Types of Measurement Functions**

Speed (rotating speed), Torque, Pm (motor output or mechanical power), synchronous speed (Sync), Slip, motor efficiency ( $\eta$ mA), and total efficiency ( $\eta$ mB). For details on the determination of the measurement functions, see appendix 1.

**Measurement Period**

**During Normal Measurement**

The numerical data is measured or computed using the sampled data<sup>\*1</sup> in the measurement period that is determined according to the following principle<sup>\*2</sup>.

- The measurement period is set between the first point where the reference input signal (synchronization source) crosses the level zero point (center of the amplitude) on the rising slope (or falling slope)<sup>\*3</sup> within the data update interval<sup>\*4</sup> and the last point where the synchronization source crosses the level zero point (center of the amplitude) on the rising slope (or falling slope) within the data update interval.
- The rising or falling edge is automatically selected for the one that allows the interval to be longer.
- If the number of rising slope or falling slope is zero or one within the data update interval, the measurement period is set to the entire span within the data update interval.
- You can select which input signal will be the synchronization source (synchronized to the zero crossing point of the input signal) for each element. You can select the voltage, current, or external clock that is input to the element to be the synchronization source signal.

\*1 For details on the sampled data, see the description of the sampled data in the earlier section "Types of Measurement Functions during Normal Measurement."

\*2 The measurement period for determining the numerical data of the peak voltage or peak current is the entire span within the data update interval. Therefore, the measurement period for the measurement functions U+pk, U-pk, I+pk, I-pk, CfU, Cfl, FfU, and Ffl that are determined from the maximum value of the voltage and current is also the entire span within the data update interval.

\*3 Slope refers to the movement of the signal from a low level to a high level (rising edge) or from a high level to a low level (falling edge).

\*4 The data update interval is the interval by which the data is sampled for determining the measurement functions. This is equivalent to the value you can specify in "Data Update Rate" of section 1.3.

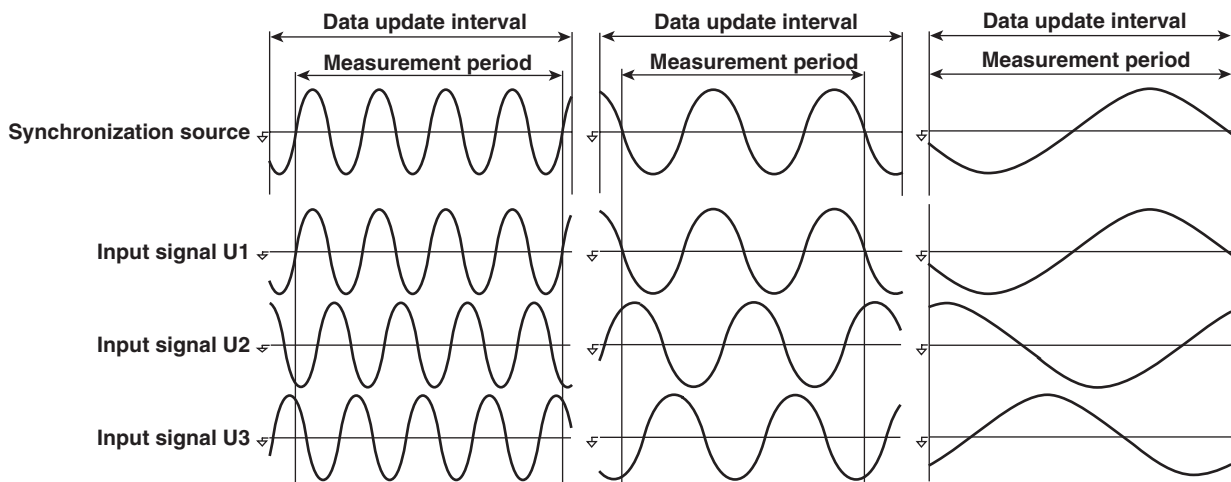

**During Harmonic Measurement**

The data length (the number of sampled data) to be used in harmonic measurement is set to 8192, 4096, or 2048 points. The selected data length is the measurement period. When the waveform is displayed, the measurement period corresponds to one screen of the waveform.





**Measurement Range «For procedures, see section 5.2.»**

Set the measurement range using an rms level. When directly inputting voltage or current signals to the input element, two types of measurement ranges is available, fixed range and auto range. When waveforms are displayed, the vertical display range corresponds to 3 or 6 times the measurement range when the crest factor (see section 5.11) is set to 3 or 6, respectively. For details on waveform display, see section 1.7, “Waveform Display.”

**Fixed Range**

Select each range from a number of choices. The selected range does not switch even if the amplitude of the input signal changes. For voltage, the maximum and minimum selectable ranges are 1000 V and 1.5 V, respectively, when the crest factor is set to 3. When the crest factor is set to 6, the maximum and minimum selectable ranges are 500 V and 750 mV, respectively.

**Auto Range**

The measurement range switches automatically depending on the amplitude of the input signal. The different ranges used in the auto range are the same as those available for fixed range.

- **Range increase**
  - When the data of measurement function  $U_{rms}$  or  $I_{rms}$  exceeds 110% of the current measurement range, the measurement range is increased.
  - When the peak value of the input signal exceeds 330% or 660% of the current measurement range when the crest factor is set to 3 or 6, respectively, the range is increased.
- **Range decrease**

When the data of the measurement function  $U_{rms}$  or  $I_{rms}$  is less than or equal to 30% of the measurement range and  $U_{pk}$  and  $I_{pk}$  is less than or equal to 300% or 600% of the next lower range when the crest factor is set to 3 or 6, respectively, the range is decreased.

**Power Range**

The measurement ranges (power ranges) of active power, apparent power, and reactive power are determined by the wiring system, voltage range, and current range as follows. For the actual values of the measurement range, see section 5.2, “Setting the Measurement Range during Direct Input.”

Wiring System	Power Range
1P2W (single-phase, two-wire)	voltage range × current range
1P3W (single-phase, three-wire)	voltage range × current range × 2
3P3W (three-phase, three-wire)	(when the voltage and current ranges on the corresponding elements are set to the same range)
3V3A (three-voltage, three-current)	
3P4W (three-phase four-wire)	voltage range × current range × 3
	(when the voltage and current ranges on the corresponding elements are set to the same range)

**Scaling «For procedures, see sections 5.3 and 5.4.»**

When inputting current signals via an external current sensor or inputting voltage or current signals via the external PT (potential transformer) or CT (current transformer), the transformation ratio and coefficient can be specified.

**When Inputting Current Signals via an External Current Sensor**

The output of current sensors, such as shunts and clamps, can be input to the current sensor connector (EXT) and be measured. Set how many mV the current sensor outputs when 1 A of current flows (transformation ratio). Then, the input signal can be made to correspond to the numerical data or waveform display data that are obtained when the current is directly applied to the input terminals.

Measurement Function	Transformation Ratio	Data before Conversion	Conversion Result
Current I	E	$I_S$ (current sensor output)	$I_S/E$
Active power P	E	$P_S$	$P_S/E$
Apparent power S	E	$S_S$	$S_S/E$
Reactive power Q	E	$Q_S$	$Q_S/E$
Max./Min. current value I <sub>pk</sub>	E	$I_{pkS}$ (current sensor output)	$I_{pkS}/E$

**When Inputting Voltage or Current Signals via an External PT or CT**

Measurements can be made by connecting the output of the secondary side of the PT and the output of the secondary side of the CT to the same voltage and current input terminals that are used when directly inputting a signal. Set the PT ratio, CT ratio, and power coefficient (coefficient multiplied to the power determined from the voltage and current). Then, the input signal can be made to correspond to the numerical data or waveform display data that are obtained when the current is directly applied to the input terminals.

Measurement Function	Data before Conversion	Conversion Result
Voltage U	$U_2$ (secondary output of PT)	$U_2 \times P$ P: PT ratio
Current I	$I_2$ (secondary output of CT)	$I_2 \times C$ C: CT ratio
Active power P	$P_2$	$P_2 \times P \times C \times SF$ SF: Power coefficient
Apparent power S	$S_2$	$S_2 \times P \times C \times SF$
Reactive power Q	$Q_2$	$Q_2 \times P \times C \times SF$
Max./Min. current value I <sub>pk</sub>	$I_{pk2}$ (secondary output of CT)	$I_{pk2} \times C$

**Input Filter «For procedures, see section 5.5.»**

There are two types of filters. This WT1600 makes measurements by synchronizing to the input signal. Therefore, the frequency of the input signal must be measured accurately.

**Line Filter**

The line filter is inserted into the circuit under measurement. It removes the noise from the inverter and from distorted waveforms. The cutoff frequency can be selected.

**Zero Crossing Filter**

This filter is inserted only into the frequency measurement circuit. Zero crossing refers to the point where the input signal crosses the center level of the amplitude. This filter is used to accurately detect the zero crossing point. The WT1600 detects the zero crossing point with a hysteresis of approximately 5% or 10% of the measurement range when the crest factor is set to 3 or 6, respectively. The zero crossing detection is used to determine the measurement period, measure the frequency, and determine the period of a PLL source.

**Averaging «For procedures, see section 5.6.»**

The averaging function is effective when reading of the numerical display is difficult due to fluctuations. This occurs when the fluctuation of the power supply or the load is large or when the input signal frequency is low.

**During Normal Measurement**

Two types, exponential average and moving average, are available.

- **Exponential average**

The numerical data can be exponentially averaged using a specified attenuation constant. Averaging is performed according to the following equation.

$$D_n = D_{n-1} + \frac{(M_n - D_{n-1})}{K}$$

$D_n$ : Displayed value that has been exponentially averaged  $n^{\text{th}}$  times. (The displayed value  $D_1$  on the first time is  $M_1$ .)

$D_{n-1}$ : Displayed value that has been exponentially averaged  $n-1^{\text{th}}$  times.

$M_n$ : Measured data on the  $n^{\text{th}}$  time.

$K$ : Attenuation constant (select from 2, 4, 8, 16, 32, and 64)

- **Moving average**

The numerical data can be linearly averaged using a specified average count. Averaging is performed according to the following equation.

$$D_n = \frac{M_{n-(m-1)} + \dots + M_{n-2} + M_{n-1} + M_n}{m}$$

$D_n$ : Displayed value obtained by linearly averaging  $m$  points of numerical data from the  $n-(m-1)^{\text{th}}$  to  $n^{\text{th}}$  time

$M_{n-(m-1)}$ : Measured data on the  $n-(m-1)^{\text{th}}$  time.

.....  
.....

$M_{n-2}$ : Measured data on the  $n-2^{\text{th}}$  time.

$M_{n-1}$ : Measured data on the  $n-1^{\text{th}}$  time.

$M_n$ : Measured data on the  $n^{\text{th}}$  time.

$m$ : Average count (select from 8, 16, 32, 64, 128, and 256)

**During Harmonic Measurement**

When the fundamental frequency is 50/60 Hz, the attenuation constant is automatically adjusted so that a first-order low-pass filter with a time constant of 1.5 s is achieved. Exponential averaging is performed using this attenuation constant. For example, if the data length for the analysis is 8192 points and the fundamental frequency of the PLL source is between 55 Hz and 75 Hz, the attenuation constant is set to 5.625. For other frequencies, it is set to 4.6875.

**Data Update Rate «For procedures, see section 5.7.»**

This is the period by which the data is sampled for determining the measurement functions.

**During Normal Measurement**

Select the value from 50 ms, 100 ms, 200 ms, 500 ms, 1 s, 2 s, and 5 s. The numerical data is updated once at the selected period. You can increase the data update rate to acquire relatively fast load fluctuations in the power system or decrease the rate to acquire sampled data for several periods even for relatively long signals.

**During Harmonic Measurement**

The data update rate is determined by the fundamental frequency of the PLL source and the number of periods of the PLL source used for the analysis.

**Hold «For procedures, see section 5.8.»**

The data display of each measurement function can be held. The communication output data while the display is held is the held numeric data.

**Single Measurement «For procedures, see section 5.8.»**

While in the held condition, the measurement is performed once at the specified data update rate and enters the held condition.

**MAX Hold «For procedures, see section 5.9.»**

Holds the maximum value of the numerical data. Holds the data of measurement functions  $U_{rms}$ ,  $U_{mn}$ ,  $U_{dc}$ ,  $U_{ac}$ ,  $I_{rms}$ ,  $I_{mn}$ ,  $I_{dc}$ ,  $I_{ac}$ ,  $P$ ,  $S$ ,  $Q$ ,  $U_{+pk}$ ,  $U_{-pk}$ ,  $I_{+pk}$ , and  $I_{-pk}$  as well as the data of the  $\Sigma$  function of these functions while the MAX hold function is enabled.

**Master/Slave Synchronized Measurement «For procedures, see section 5.10.»**

With the master instrument outputting measurement start and stop signals and the slave instrument receiving those signals, synchronized measurement on two instruments is achieved.

# 1.4 Numeric Display

The numerical data can be displayed. The display format differs between normal measurement and harmonic measurement. In addition, the screen can be divided into top and bottom halves so that the numerical data can be displayed simultaneously with waveforms, bar graphs, or trends (explained later).

## Display Resolution

The display resolution for voltage, current, active power, apparent power, reactive power, and so on is 60000. When the range rating (rated value of the specified range) is applied, the  $\Sigma$  function of voltage, current, active power, apparent power, reactive power, and so on is set to the decimal point position and unit of the element with the lowest display resolution of the target elements. For the display resolution during integration, see section 6.11.

## Numerical Display during Normal Measurement «For procedures, see sections 4.1 and 6.1.»

### Selecting the Number of Displayed Items

You can select the number of displayed items in the range from 4 to all. When the numerical data is displayed simultaneously with waveforms, bar graphs, or trends, only half of the selected number of items is displayed. Not all the data can be displayed on one screen. Thus, you can scroll through the displayed items to view the succeeding data.

- Example in which eight items are displayed

	Urms1	5.1290 V	
Measurement function	Umn1	4.5265 V	Data
	Udc1	1.1130 V	
	Uac1	5.0068 V	
	Irms1	4.9235 A	
	Imn1	4.9231 A	
	Idc1	-0.0434 A	
	Iac1	4.9233 A	

- Example in which all items are displayed

		Element and wiring system						
		Element1	Element2	Element3	Element4	Element5		
Measurement function	Urms[V]	94.66	0.000k	0.000k	0.000k	0.000k	Data	
	Umn[V]	94.64	0.000k	0.000k	0.000k	0.000k		
	Udc[V]	-0.05	-0.0001k	0.000k	0.000k	0.000k		
	Uac[V]	94.66	0.000k	0.000k	0.000k	0.000k		
	Irms[A]	0.0031k	0.0000	0.163	0.168	0.165		
	Imn[A]	0.000k	0.0000	0.000	0.000	0.000		
	Idc[A]	0.000k	-0.0003	-0.000	-0.006	-0.006		
	Iac[A]	0.0031k	0.0000	0.163	0.168	0.165		
	P [W]	0.00k	-0.0000k	0.000k	0.000k	0.000k		
	S [VA]	0.29k	0.000k	0.000k	0.000k	0.000k		
	Q [var]	0.29k	0.000k	0.000k	0.000k	0.000k		
	$\lambda$ [ ]	0.0000	0.0000	0.0000	0.0000	0.0000		
			Element6	$\Sigma$ A	$\Sigma$ B	$\Sigma$ C		
	Urms[V]	0.000k	94.66	0.000k	0.000k	0.000k		
Umn[V]	0.000k	94.64	0.000k	0.000k	0.000k			
Udc[V]	0.000k	-0.05	-0.0001k	0.000k	0.000k			
Uac[V]	0.000k	94.66	0.000k	0.000k	0.000k			
Irms[A]	0.159	0.0031k	0.0000	0.163				
Imn[A]	0.000	0.000k	0.0000	0.000				
Idc[A]	-0.007	0.000k	-0.0003	-0.006				
Iac[A]	0.159	0.0031k	0.0000	0.163				
P [W]	0.000k	0.00k	-0.0000k	0.000k				
S [VA]	0.000k	0.29k	0.000k	0.000k				
Q [var]	0.000k	0.29k	0.000k	0.000k				
$\lambda$ [ ]	0.0000	0.0000	0.0000	0.0000				

**Changing the Displayed Items**

By selecting a displayed item, the numerical data value that is displayed at the position can be changed.

Urms1	5.0517 V		Urms1	5.0517 V
Urn1	5.0516 V		Urn1	5.0516 V
<b>Udc1</b>	<b>-0.0315 V</b>	Change the measurement function of the third item →	<b>Urn1</b>	<b>5.0516 V</b>
Uac1	5.0516 V		Uac1	5.0516 V
Irms1	5.0530 A		Irms1	5.0530 A
Imn1	5.0551 A		Imn1	5.0551 A
		Change the element of the third item →	Urms1	5.0517 V
			Urn1	5.0516 V
			<b>Udc2</b>	<b>-0.0307 V</b>
			Uac1	5.0516 V
			Irms1	5.0530 A
			Imn1	5.0551 A

**Scrolling the Page**

Not all the data can be displayed on one screen. Thus, you can scroll the page to display the succeeding (or preceding) data.

**Resetting the Numerical Display**

If the number of displayed items is set to a value other than All, the display order of measurement functions can be reset to the default order (1 default set).

**Numerical Display during Harmonic Measurement «For procedures, see sections 4.1 and 7.2.»****Selecting the Number of Displayed Items**

You can select four, eight or 16 for the number of displayed items. When the numerical data is displayed simultaneously with waveforms, bar graphs, or trends, only half of the selected number of items is displayed. Not all the data can be displayed on one screen. Thus, you can scroll through the displayed items to view the succeeding data.

**Example in which eight items are displayed**

	U1	5.0545 V	
	I1	4.7348 A	
Measurement function	P1	0.067 W	Data
	S1	0.082 VA	
	Q1	0.047 var	
	U1(1)	4.0427 V	
	I1(1)	0.0172 A	
	P1(1)	0.069 W	

**Changing the Displayed Items When Four, Eight, or 16 Items Are Displayed**

By selecting a displayed item, the numerical data value that is displayed at the position can be changed.

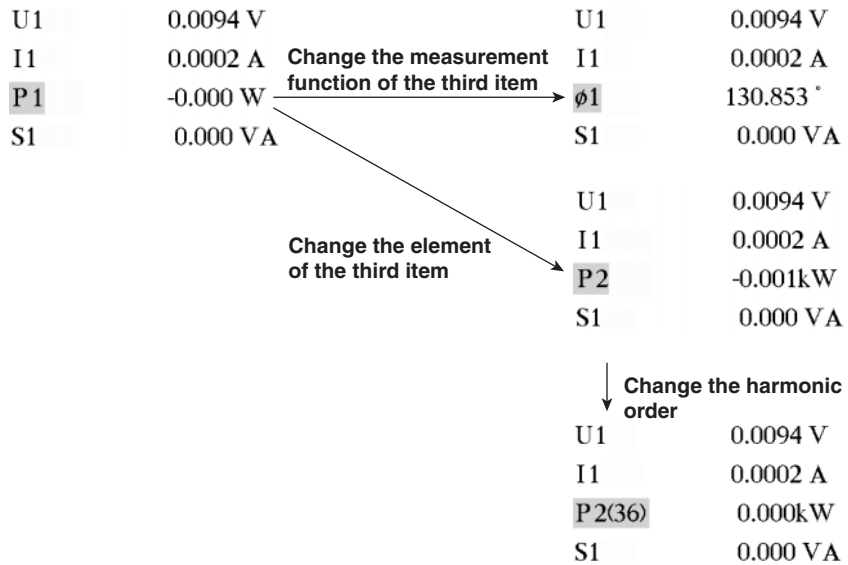

**List Display**

For each measurement function, the numerical data of the fundamental and all harmonics can be displayed in two columns. When the numerical data is displayed simultaneously with waveforms, bar graphs, or trends, approximately half of the data is displayed.

- **Single list**

The data of a single measurement function is displayed by separating the even and odd harmonics in each column. You can select the following measurement functions: U, I, P, S, Q, λ, φ, φU, φI, Z, Rs, Xs, Rp, and Xp.

PLL	U1	5.0545	-----	dc	1.0429	20.633
Freq	46 Hz	1 4.0427	79.902	2	3.0339	60.023
		3 0.0144	0.285	4	0.0068	0.135
U1	5.0545 V	5 0.0059	0.117	6	0.0048	0.096
I1	4.7348 A	7 0.0037	0.072	8	0.0041	0.080
P1	0.067 W	9 0.0021	0.041	10	0.0021	0.043
S1	0.	11 0.0022	0.044	12	0.0022	0.043
Q1	0.	13 0.0022	0.043	14	0.0016	0.032
λ1	0.81	15 0.0018	0.035	16	0.0014	0.029
φ1	-35.	17 0.0009	0.018	18	0.0013	0.026
Uthd1	75.	19 0.0015	0.030	20	0.0012	0.023
Ithd1	7524.	21 0.0007	0.013	22	0.0012	0.023
Pthd1	3.	23 0.0012	0.023	24	0.0007	0.014
Uthf1	Er	25 0.0004	0.008	26	0.0011	0.022
Ithf1	Er	27 0.0008	0.016	28	0.0014	0.028
Uthf1	1.	29 0.0008	0.016	30	0.0007	0.014
Ithf1	4999.	31 0.0009	0.018	32	0.0010	0.021
hcf1	0.	33 0.0008	0.016	34	0.0006	0.011
hcf1	0.	35 0.0010	0.019	36	0.0010	0.020
F1	-----	37 0.0010	0.020	38	0.0007	0.014
F2	-----	39 0.0005	0.010	40	0.0007	0.014
F3	-----	41 0.0002	0.004	42	0.0004	0.007
F4	-----	43 0.0006	0.011	44	0.0005	0.010
φU1-U2	-----	45 0.0004	0.009	46	0.0007	0.014

Data related to all harmonic signals

Harmonic order

Numerical data of each harmonic

Harmonic distortion factor  
(When the selected measurement function is U, I, or P, Uthd, Ithd, or Pthd is displayed, respectively.)

• **Dual list**

The data of two measurement functions is displayed in its own column. You can select the following measurement functions: U, I, P, S, Q, λ, φ, φU, φI, Z, Rs, Xs, Rp, and Xp.

Data related to all harmonic signals

	U1	5.0545	4.7348
PLL	dc	1.0429	28.633
Freq	46 Hz	1	4.0427
		79.982	1
		0.0172	0.363
U1	5.0545 U	2	3.0339
I1	4.7348 A	3	0.0144
P1	0.067 U	4	0.0068
S1	0.0 U	5	0.0059
Q1	0.0 U	6	0.0048
λ1	0.816	7	0.0037
φ1	-35.2	8	0.0041
Uthd1	75.0	9	0.0021
Ithd1	7524.6	0	0.0021
Pthd1	3.0	1	0.0022
Uthf1	Err	2	0.0022
Ithf1	Err	3	0.0022
Uthf1	1.9	4	0.0016
Ithf1	4999.0	5	0.0018
hpf1	0.4	6	0.0014
hcf1	0.2	7	0.0009
F1		8	0.0013
F2		19	0.0015
F3		20	0.0012
F4		21	0.0007
φU1-U2		22	0.0012

Harmonic order

Numerical data of each harmonic

Harmonic distortion factor  
(When the selected measurement function is U, I, or P, Uhd1, Ihd1, or Phd1 is displayed, respectively.)

• **Σ list**

Displays the numerical data of measurement functions (such as U, I, P, S, Q, λ, φ, φU, φI, Z, Rs, Xs, Rp, Xp, φU1-U2, φU1-U3, φU1-I1, φU1-I2, and φU1-I3) of each element and each wiring system for the selected harmonic orders.

Element and wiring system

Or.	1	Element1	Element2	Element3	Σ A
U	[U]	94.04	0.0000k	0.0000k	0.0316k
I	[I]	0.0001k	0.0001	0.002	0.0000k
P	[P]	0.01k	0.0000k	0.000k	0.01k
S	[S]	0.01k	0.0000k	0.000k	0.01k
Q	[Q]	-0.01k	-0.0000k	0.000k	-0.01k
λ	[λ]	0.6467	0.8159	0.0000	0.6467
φ	[φ]	310.29	324.58		
φU	[φU]				
φI	[φI]				
Z	[Z]	1.1566k	230.95	0.00	
Rs	[Rs]	748.00	237.12	0.00	
Xs	[Xs]	-882.19	-168.62	0.00	
Rp	[Rp]	1.7884k	357.02	0.00	
Xp	[Xp]	-1.5164k	-502.06	0.00	
		Σ A			
φU1-U2	[φU1-U2]				
φU1-U3	[φU1-U3]				
φU1-I1	[φU1-I1]	310.29			
φU1-I2	[φU1-I2]				
φU1-I3	[φU1-I3]				

Measurement function

**Scrolling the Page**

Not all the harmonic data can be displayed on one screen. When the list display is not set to Σ list, you can scroll the page to display the succeeding (or preceding) data.

**Resetting the Numeric Display**

If the number of displayed items is set to four, eight, or 16, the display order of measurement functions can be reset to a default order (1 default set).



## 1.5 Computation

By using the data of measurement functions, the following types of computation can be performed. In addition, a function is provided in which the equation used to determine the measurement function data can be selected.

### User-Defined Functions «For procedures, see sections 6.4 and 7.8.»

Equations can be created (defined) by combining the measurement function symbols and operators. The numerical data corresponding to the equation can then be determined. The combination of a measurement function and element number (Urms1, for example) constitutes an operand. Four equations (F1 through F4) can be defined for normal measurement and harmonic measurement.

#### Operators

There are 11 types of operators: +, −, \*, /, ABS (absolute value), SQR (square), SQRT (square root), LOG (logarithm), LOG10 (common logarithm), EXP (exponent), and NEG (negation).

#### Number of Operands

There can be up to 16 operands in one equation.

### Delta Computation «For procedures, see section 6.5.»

Delta computation can be performed during normal measurement. For example, if elements 1, 2, and 3 are assigned to wiring A, the sum or difference of the instantaneous values (sampled data) of the voltage or current between elements 1, 2, and 3 can be determined. Then, from the results, the measurement functions  $\Delta U_{rms}$ ,  $\Delta I_{rms}$ ,  $\Delta U_{mn}$ ,  $\Delta I_{mn}$ ,  $\Delta U_{dc}$ ,  $\Delta I_{dc}$ ,  $\Delta U_{ac}$ , and  $\Delta I_{ac}$  can be determined. This operation is called delta computation. The delta computation can be used, for example, to perform star-to-delta transformation of a three-phase AC circuit. For the equation, see appendix 2. The measurement period is the same as that described in section 1.2, "Measurement Function and Measurement Period."

### Equation for the Apparent Power «For procedures, see section 6.6.»

The apparent power can be determined by the product of the voltage and current. The voltage and current can be selected from the four types, (1) the true rms value, (2) the rectified mean value calibrated to the rms value, (3) the simple average, and (4) the rectified mean value calibrated to the rms value for the voltage and the true rms value for the current, as explained in "Determining the Voltage and Current" in section 1.2, "Measurement Function and Measurement Period."

### Corrected Power «For procedures, see section 6.6.»

Depending on the applicable standard, when the load that is connected to the potential transformer is extremely small, the active power of the potential transformer that is measured needs to be compensated. In such case, set the compensating equation and the coefficient.

**IEC76-1(1976), IEEE C57.12.90-1993**

$$P_c = \frac{P}{P_1 + P_2 \left( \frac{U_{rms}}{U_{mn}} \right)^2}$$

P<sub>c</sub>: Corrected Power

P: Active power

U<sub>rms</sub>: True rms voltage

U<sub>mn</sub>: Voltage (rectified mean value calibrated to the rms value)

P<sub>1</sub>, P<sub>2</sub>: Coefficient as defined in the applicable standard

**IEC76-1(1993)**

$$P_c = P \left( 1 + \frac{U_{mn} - U_{rms}}{U_{mn}} \right)$$

**Phase Difference «For procedures, see section 6.7.»**

The display format of the phase difference between the voltage and current of each element can be selected. With the voltage of each element as a reference, one format displays the phase difference using  $360^\circ$  in the clockwise direction, and the other format displays a lead of  $180^\circ$  in the counter-clock wise direction and a lag of  $180^\circ$  in the clockwise direction.

**Equation for the Distortion Factor «For procedures, see section 7.6.»**

The measurement functions, Uhd<sub>f</sub>, lhdf, Phdf, Uthd, lthd, and Pthd during harmonic measurement have two defining equations that you can select from. For the equations, see appendix 1.

## 1.6 Integration

The WT1600 can integrate the active power (watt hour) and current (current hour). During integration, the measured and computed values of normal measurements can be displayed in addition to the watt hour, current hour, and integration time. However, integration cannot be performed when the waveform display is turned ON.

### Measurement Functions of Integration

#### Measurement Functions on Each Input Element

The following seven types of numerical data can be determined. For details on the determination of each measurement function data, see appendix 1.

Wp (watt hour, sum of positive and negative watt hours), Wp+ (positive watt hour consumed), Wp- (negative watt hour returned to the power supply (regenerated energy)), q (current hour, sum of positive and negative current hours), q+ (positive current hour consumed), q- (negative current hour returned to the power supply), Time (integration time)

#### Measurement functions of the sum of input elements ( $\Sigma$ functions)

The following six types of numerical data can be determined. For details on the determination of each measurement function data, see appendix 1.

Wp $\Sigma$  (sum of Wp), Wp+ $\Sigma$  (sum of Wp+), Wp- $\Sigma$  (sum Wp-), q $\Sigma$  (sum of q), q+ $\Sigma$  (sum of q+), q- $\Sigma$  (sum of q-)

### Integration Mode «For procedures, see sections 6.8 and 6.9.»

#### Manual Integration Mode

Integration continues from the point when integration is started to the point it is stopped. However, when the integration time reaches its maximum (10000 hours) or the integration value reaches its maximum or minimum ( $\pm 999999$  MWh or  $\pm 999999$  MAh), the integration is stopped and the integration time and integration value at that point are held.

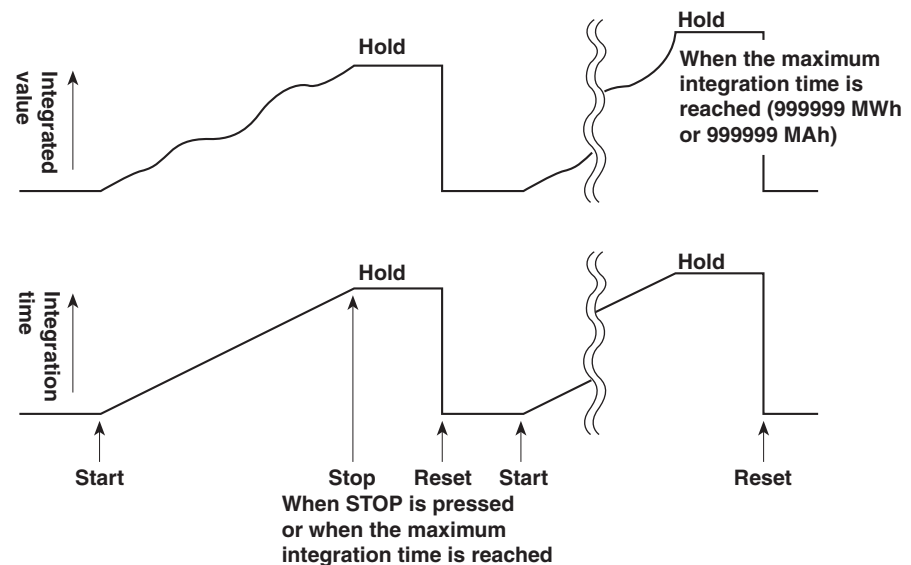

**Normal Integration Mode**

The integration time is set in relative time. The integration is stopped after the specified time elapses or when the integration value reaches the maximum or minimum integration display value. The integration time and value are held at that point.

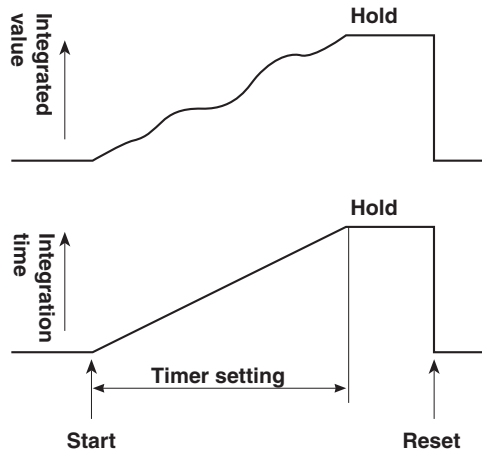
**Repetitive Integration Mode (Continuous Integration)**

The integration time is set in relative time. When the specified time elapses, the operation is automatically reset and restarted. Integration is repeated until STOP is pressed. When the integration value reaches the maximum or minimum integration display value. The integration time and value are held at that point.

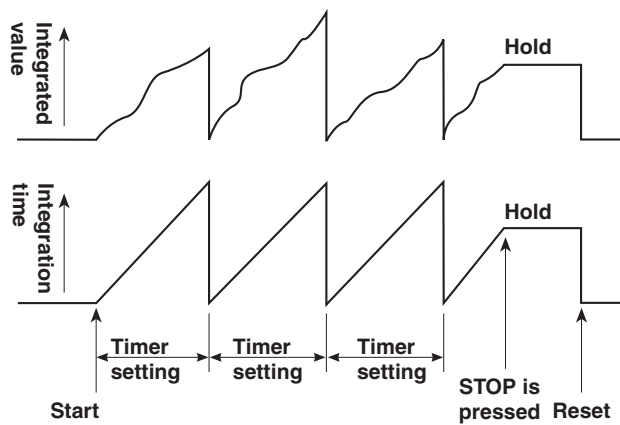

**Real-time Normal Integration Mode**

The start and stop of the integration operation is set through date and time. The integration is stopped at the specified time or when the integration value reaches the maximum or minimum integration display value. The integration time and value are held at that point.

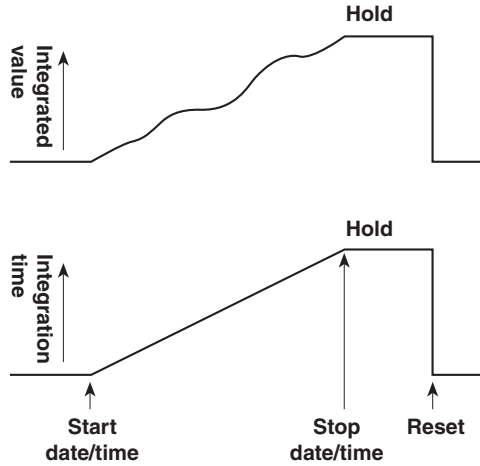

**Real-time Repetitive Integration Mode (Continuous Integration)**

The start and stop of the integration operation is set through date and time. The integration is repeated at the specified timer setting during that time. When the time specified by the timer elapses, the operation is automatically reset and restarted. The integration is stopped at the specified time or when the integration value reaches the maximum or minimum integration display value. The integration time and value are held at that point.

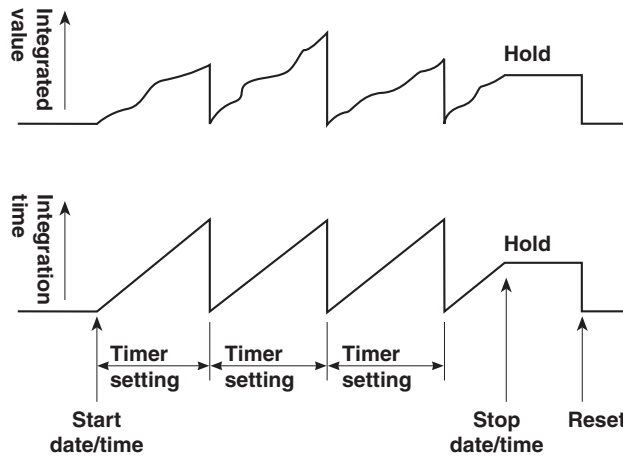

## 1.7 Waveform Display

The WT1600 displays waveforms based on the data sampled within the data update rate.

### Vertical (Amplitude) Axis

The vertical display range is determined based on the specified measurement range. For example, if the crest factor is set to 3 and the voltage measurement range is set to "100 Vrms," then the display range is set so that the top of the screen is 300 Vpk ( $100 \text{ Vrms} \times 3$ ) and the bottom is  $-300 \text{ Vpk}$  ( $-100 \text{ Vrms} \times 3$ ) with the zero input line at the center. If the crest factor is set to 6 and the voltage measurement range is set to "50 Vrms," then the display range is set so that the top of the screen is 300 Vpk ( $50 \text{ Vrms} \times 6$ ) and the bottom is  $-300 \text{ Vpk}$  ( $-50 \text{ Vrms} \times 6$ ) with the zero input line at the center. However, the display range for a measurement range of 1000 V or 500 V when the crest factor is set to 3 or 6, respectively, is within  $\pm 2000 \text{ V}$ . The waveform clips if this range is exceeded.

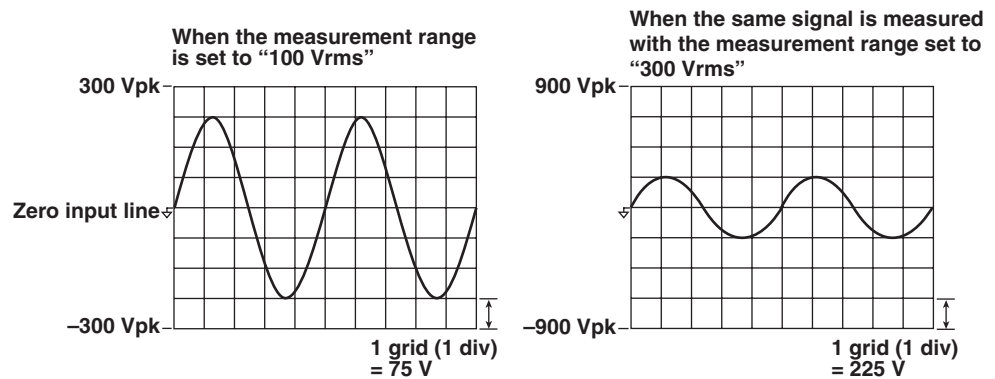

### Horizontal (Time) Axis «For procedures, see section 9.2.»

Set the horizontal (time) axis by specifying the time per grid (1 division). The time axis can be set in 1, 2, or 5 steps in the range up to the point in which the time corresponding to one screen is equal to the data update rate. For example, if the data update rate is 500 ms, the time per division can be changed in the order, 0.5 ms, 1 ms, 2 ms, 5 ms, 10 ms, 20 ms, and 50 ms.

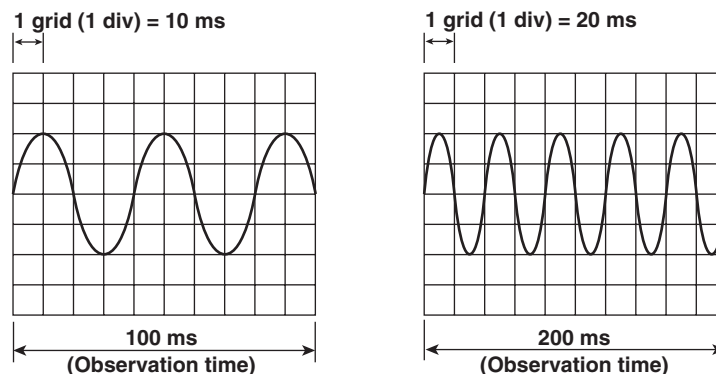

### During Normal Measurement

The time axis can be set in 1, 2, or 5 steps in the range up to the data update rate according to the horizontal (time) axis setting described earlier. For example, changing the time per division in the order 0.5 ms, 1 ms, 2 ms, 5 ms, 10 ms, 20 ms, and 50 ms changes the time corresponding to one screen in the order 5 ms, 10 ms, 50 ms, 100 ms, 200 ms, and 500 ms.

**During Harmonic Measurement**

The time corresponding to one screen in harmonic measurement is automatically determined from the sample rate, which can be derived from the fundamental frequency of the PLL source (see page 1-7), and the window width (time width over which FFT analysis is performed when determining harmonics).

**Note**

**Number of displayed points on the screen**

When waveforms are displayed, the data points (waveform display data) are displayed in segments called rasters. There are 501 rasters in the time axis direction on one screen.

On the other hand, data is sampled according to the sample rate, and one screen of the sampled data becomes the data that is displayed on the screen as a waveform.

Because the number of display segments (number of displayed points) on the screen is constant at 501 rasters while the number of sampled data points varies according to the time corresponding to one screen, the following process is performed.

P-P compression is performed over a certain period along the time axis, the waveform display data is determined, and the data is displayed. P-P compression refers to the determination of the maximum and minimum values for each certain period. One raster will display these two points.

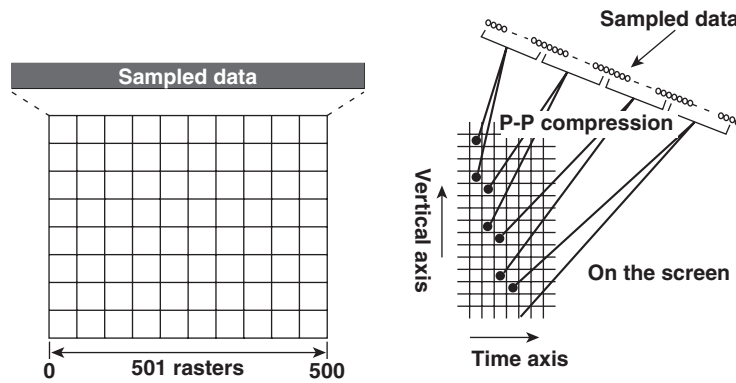

**Aliasing**

When the sample rate is comparatively low with respect to the input signal frequency, the harmonics contained in the signal are lost. In this case, some of the harmonics will appear at low frequencies due to the effects described by the Nyquist sampling theorem. This phenomenon is called aliasing.

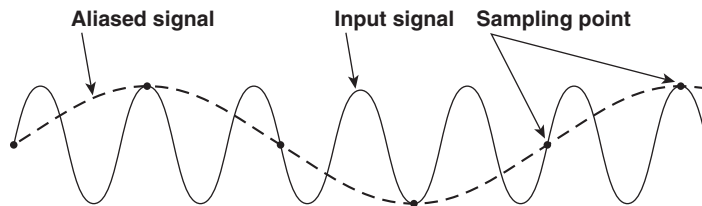

**Retrieval of Waveform Display Data**

The WT1600 retrieves waveform display data to the memory at a sample rate of approximately 200 kS/s. The frequency that allows displaying of waveforms that are close to the input signal is up to approximately 10 kHz.

**Trigger** «For procedures, see section 9.3.»

Trigger is a cue used to display the waveform on the screen. The trigger is activated when the specified trigger condition is met. At this point, the waveform is ready to be displayed on the screen.

**Trigger Source**

Trigger source refers to the signal that is used in checking the trigger condition.

**Trigger Slope**

Slope refers to the movement of the signal from a low level to a high level (rising edge) or from a high level to a low level (falling edge). When the slope is used as one of the trigger conditions, it is called a trigger slope.

**Trigger Level**

Trigger level refers to the level through which the trigger slope passes.

When the slope of the trigger source passes through the specified trigger level on a rising or falling edge, a trigger occurs. You can select the input signal of each element or external clock input signal as a trigger source.

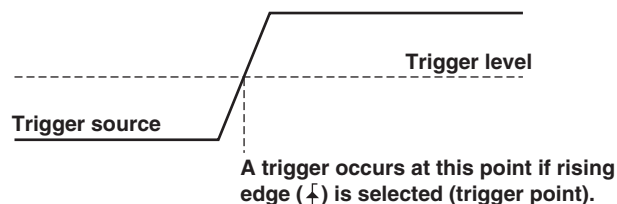
**Trigger Mode**

Trigger mode specifies the conditions for updating the screen display.

- **Auto mode**

If a trigger occurs within a specified amount of time (about 100 ms, referred to as the timeout period), the waveform display is updated. If a trigger does not occur within the timeout time, the display is automatically updated when the timeout time elapses.

- **Normal mode**

The display is updated only when the trigger occurs. The display is not updated if the trigger does not occur.

**Trigger Point**

Trigger point refers to the point at which a trigger occurred. The trigger point is always at the left end of the screen. The waveform after the trigger point is displayed from the left to the right of the screen as the time progresses.

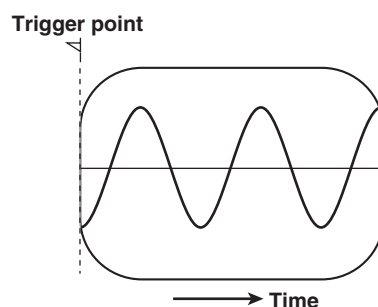



**Zooming on the Waveform «For procedures, see section 9.4.»**

Each displayed waveform can be expanded or reduced vertically by the zoom factor in the range of 0.1 to 100. The waveform is zoomed around the zero input line.

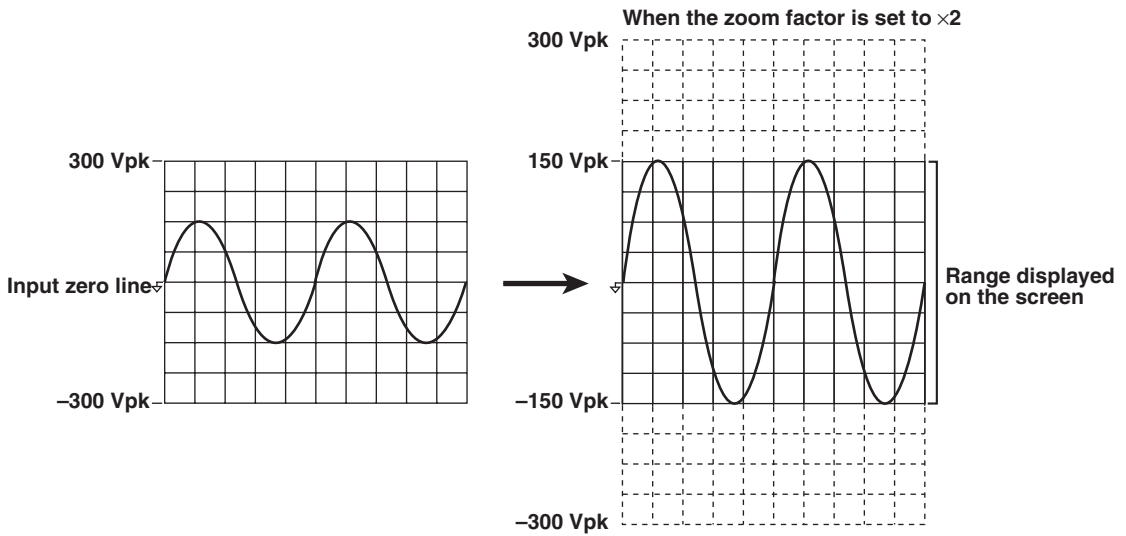

**Vertical Position of the Waveform «For procedures, see section 9.4.»**

The displayed position of the waveform can be moved vertically to the desired position such as when you wish to view the mutual relationship between the voltage and current waveforms or when the section of the waveform you wish to view goes out of the display frame.

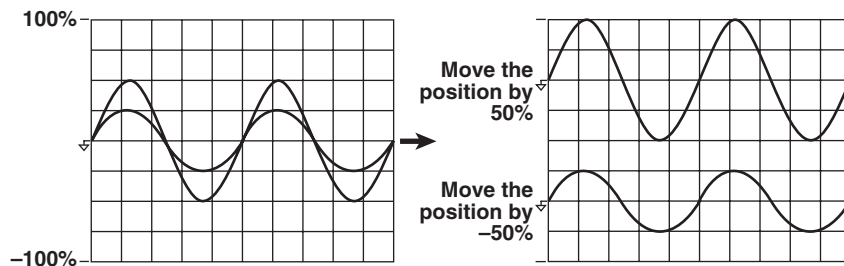

**Turning ON/OFF of the Waveform Display «For procedures, see section 9.5.»**

The voltage and current waveforms corresponding to the element that has input modules installed can be turned ON/OFF. This feature enables easy viewing of waveforms as only the required waveforms can be displayed.

## Split Screen of the Waveform and Waveform Mapping

«For procedures, see section 9.6»

The screen can be evenly divided and the waveforms can be mapped to the divided windows. The screen can be divided into up to four windows. This function is useful when there are many waveforms on the screen. You can select the method of mapping from the following list of choices:

- Auto

The waveforms that are turned ON are mapped in order according to the element number to the divided windows, voltage first and then current.

- Fixed

The waveforms are mapped in order by element number in the order voltage and current to the divided windows regardless of whether or not the display is turned ON.

- User

The waveforms can be mapped arbitrarily to the divided windows regardless of whether or not the display is turned ON.

## Display Interpolation of the Waveform «For procedures, see section 9.7.»

The waveform display data can be connected linearly to display the waveform smoothly.

### Linear Interpolation

Linearly interpolates between two points.

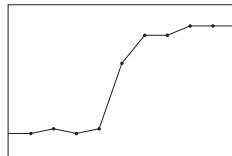

### Interpolation OFF

No interpolation is performed. Only the data points are displayed.

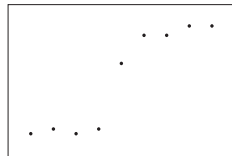

## Graticule «For procedures, see section 9.7.»

A grid or cross scale can be displayed on the screen. You can also select not to display the grid or cross scale.

## Displaying Scale Values «For procedures, see section 9.8.»

The upper and lower limits of the vertical axis and the values at the left and right ends of the horizontal axis (time axis) of each waveform can be turned ON or OFF.

**Displaying Waveform Labels «For procedures, see section 9.8.»**

Waveform labels can be turned ON or OFF.

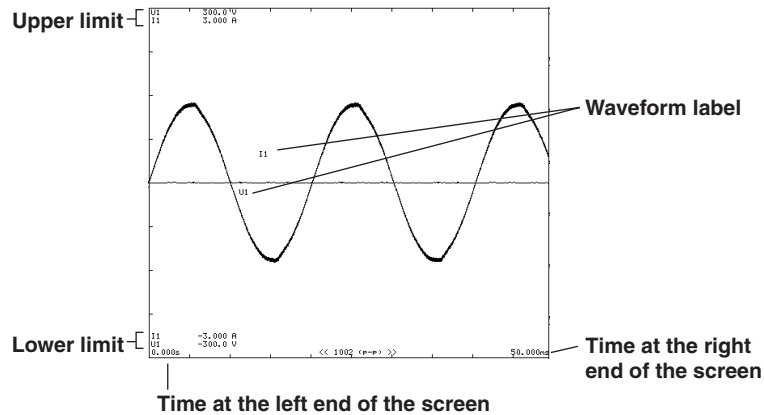

**Cursor Measurement «For procedures, see sections 7.9, 9.9, and 10.7.»**

The value at the crossing point of the waveform and cursor can be measured and displayed. It can be used to measure the voltage and current of various sections of the waveform and the data on the horizontal axis (X-axis). Cursor measurements are performed on the data that is displayed on the screen.

Cursors are the “+” and “x” marks that are displayed on the screen. The vertical value and the X-axis value from the left end of the screen for each cursor can be measured. In addition, the difference in the vertical values and in the X-axis values between the cursors can be measured.

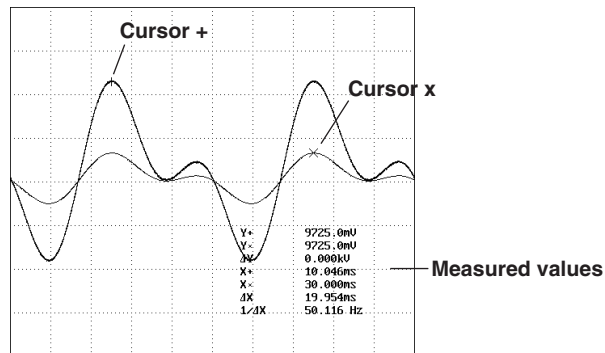

## 1.8 Bar Graphs, Vectors, and Trend Displays

Bar graphs of harmonics of each order, vectors of the fundamental signal of each element (during harmonic measurement), and trends of each measurement function can be displayed.

### Bar Graph Display of Harmonic Data «For procedures, see section 7.9.»

The amplitude of each harmonic can be displayed on the bar graph. The horizontal axis represents harmonic order, and the vertical axis represents the amplitude of each harmonic. The harmonic measurement functions, elements, and order to be displayed can be specified. You can select the following harmonic measurement functions: U, I, P, S, Q,  $\lambda$ ,  $\phi U$ ,  $\phi I$ , Z, Rs, Xs, Rp, and Xp. The screen can be divided into top and bottom halves so that the bar graph can be displayed simultaneously with the numerical data.

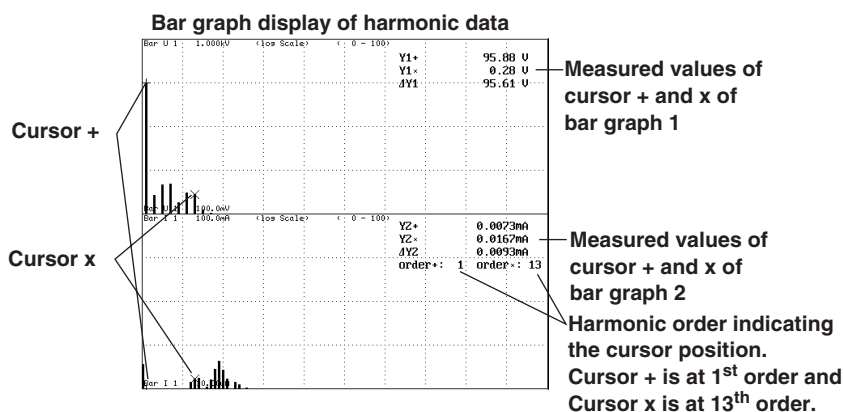

### Vector Display of Harmonics «For procedures, see section 7.10.»

During harmonic measurement, vectors can be displayed to show the relationship between the phase difference and amplitude (rms value) of the fundamental signals U(1) and I(1) of each element that is assigned to the selected wiring unit. The positive vertical axis is set to 0 (angle 0), and the vector of each input signal is displayed. In addition, you can zoom in on the vector or display the values of the amplitude and the phase difference between the signals simultaneously.

The vector display is shown on the next page.

The elements that are to be displayed as vectors vary depending on the number of installed input elements and the selected wiring pattern.

Explanation is given below for the case when the number of installed input elements is 5, the wiring system pattern is three-phase, four-wire for  $\Sigma A$  and three-phase, three-wire for  $\Sigma B$ .

When the target of the harmonic measurement is set to wiring unit  $\Sigma A$ , the target elements are 1, 2, and 3. Vectors 1, 2, and 3 correspond to elements 1, 2, and 3, respectively. The relationship between the phase difference and amplitude of U1(1), U2(1), U3(1), I1(1), I2(1), and I3(1) is displayed as vectors.

When the target of the harmonic measurement is set to wiring unit  $\Sigma B$ , the target elements are 4 and 5. Vectors 4 and 5 correspond to elements 4 and 5, respectively. The relationship between the phase difference and amplitude of U4(1), U5(1), I4(1), and I5(1) is displayed as vectors. The vectors for U6(1) and I6(1) are computed and displayed.

## 1.8 Bar Graphs, Vectors, and Trend Displays

### Vector display when the wiring system is 3P4W (three-phase, four-wire)

$U_1(1)$ ,  $U_2(1)$ , and  $U_3(1)$  are common mode voltages.  $I_1(1)$ ,  $I_2(1)$ , and  $I_3(1)$  are line currents.

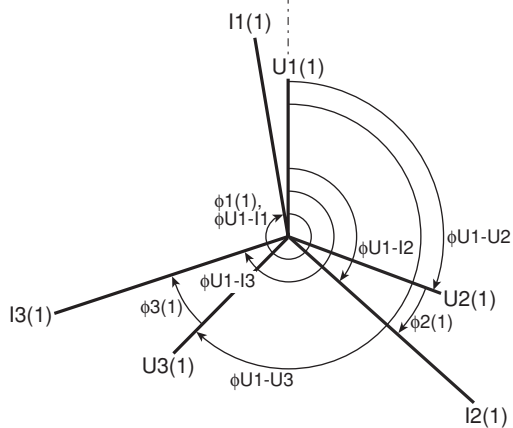

### Vector display when the wiring system is 3V3A (three-voltage, three-current)

$U_1(1)$ ,  $U_2(1)$ , and  $U_3(1)$  are line voltages.  $I_1(1)$ ,  $I_2(1)$ , and  $I_3(1)$  are line currents.

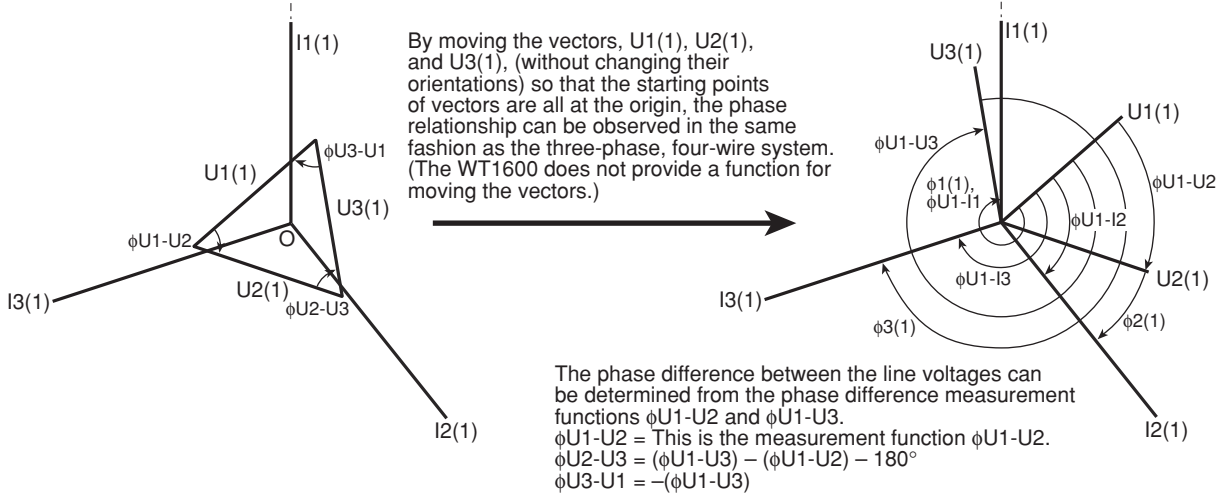

### Vector display when the wiring system is 3P3W (three-phase, three-wire)

$U_1(1)$ ,  $U_2(1)$ , and  $U_3(1)$  are line voltages.  $I_1(1)$ ,  $I_2(1)$ , and  $I_3(1)$  are line currents. However,  $U_3(1)$  and  $I_3(1)$  are not actually measured for the three-phase, three-wire system. The vectors are displayed through computation.

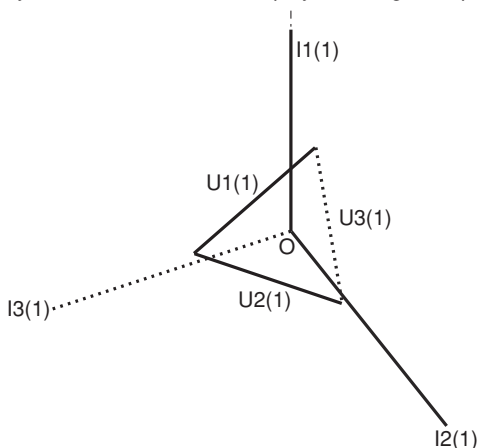

## Trend Display

The trends of all measurement functions that are measured during normal measurement and harmonic measurement are displayed.

### Trend Display Data

When the retrieval of waveform display data is OFF during normal measurement, the numerical data of measurement functions that is determined for each data update rate is P-P compressed\* for each display segment (raster) and made into trend display data.

When the retrieval of waveform display data is ON during normal measurement, the numerical data of measurement functions that is determined each time a trigger occurs is P-P compressed\* for each display segment (raster) and made into trend display data.

During harmonic measurement, the numerical data of the measurement function that is automatically determined from the sample rate, which can be derived from the fundamental frequency of the PLL source (see page 1-7), and the window width (time width over which FFT analysis is performed when determining harmonics) is P-P compressed\* for each display segment (raster) and made into trend display data.

\* In some cases, P-P compression is not performed.

### Split Screen Display and Assignments «For procedures, see section 10.4.»

Up to 16 lines (T1 through T16) of trends can be displayed. You can select the measurement function of any element to be assigned to T1 through T16. During harmonic measurement, you can also specify the harmonic order.

The screen is divided up to 4 windows and the trends that are turned ON are mapped to the divided windows in order from T1 through T16.

### Horizontal (Time) Axis «For procedures, see section 10.5.»

When the retrieval of waveform display data is OFF during normal measurement, the time per division can be set in the range of 3 s to 1 day. When the retrieval of waveform display data is ON during normal measurement or during harmonic measurement, the value can be set in terms of the number of measurements per division.

### Setting the Scale «For procedures, see section 10.6.»

Auto scaling is provided in which the upper and lower limits of the screen are determined automatically from the maximum and minimum values of the trend display data. Manual scaling is also available in which the upper and lower limits can be set arbitrarily as necessary.

### Display Interpolation, Graticule, and Label Display

«For procedures, see sections 9.7 and 9.8.»

The settings specified for waveform display are used.

## 1.9 Saving and Loading Data and Other Functions

### Storing and Recalling «For procedures, see chapter 11.»

The numerical data and waveform display data can be stored to the internal memory (approximately 12 MB, or approximately 11 MB when using a WT1600 with ROM version 2.01 or later). The data is stored to the internal memory at the data update rate or the specified time interval. In addition, the stored data can be saved to a floppy disk or built-in hard disk. The data that is saved to the built-in hard disk or floppy disk cannot be recalled.

### Saving and Loading to the Floppy Disk, Built-in Hard Disk, and External SCSI Device «For procedures, see chapter 12.»

A floppy disk (FD) drive comes standard with the instrument. Additionally, a built-in hard disk or SCSI can be installed as an option. The numerical data, waveform display data, screen image data, and setup parameters can be saved to these media. The saved setup parameters can be loaded as necessary. The screen image data can be pasted to documents on a word-processing application.

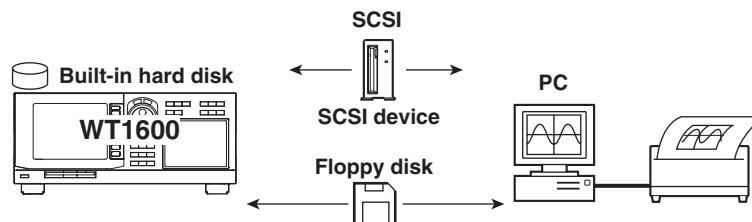

### Printing on the Built-in Printer «For procedures, see chapter 14.»

The screen image, numerical data list, and bar graphs can be printed on the built-in printer (option).

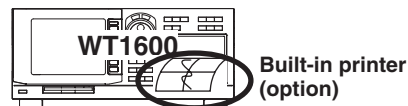

### Ethernet Communications (Option) «For procedures, see chapter 13.»

The numerical data, waveform display data, screen image data, and setup parameters can be saved to a device connected via the Ethernet interface or information about the WT1600 can be transmitted.

#### Saving and Loading from an FTP Server on the Network (FTP Client Function)

The numerical data, waveform display data, screen image data, and setup parameters can be saved to an FTP server\* on the network in the same fashion as with the floppy disk or external SCSI device. The saved setup parameters can also be loaded as necessary.

\* PC or workstation on which the FTP server function is running.

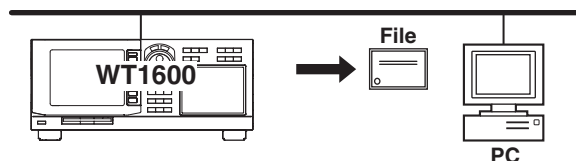

**Accessing the WT1600 from an FTP Client on the Network (FTP Server Function)**

The WT1600 can be accessed from an FTP client\* on the network, and files on the floppy disk, built-in hard disk, and external SCSI device connected to the WT1600 can be retrieved.

\* PC or workstation on which the FTP client function is running.

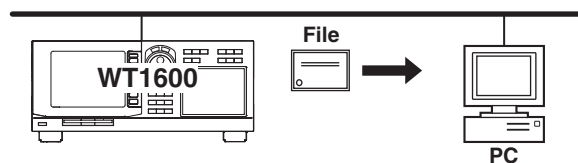
**Outputting to a Network Printer (LPR Client Function)**

The screen image can be printed to a network printer in the same fashion as with the built-in printer.

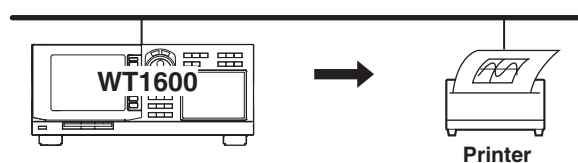
**Sending Mail (SMTP Client Function)**

The information of the WT1600 can be transmitted periodically to a specified mail address.

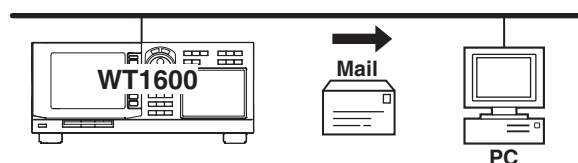
**GP-IB/Serial Communication «See the *Communication Interface User's Manual IM760101-11E*.»**

Either a GP-IB interface or a serial interface (conforming to EIA-574 (9-pin EIA-232 (RS-232))) comes standard with the WT1600 (specified at the time of purchase). The measured data can be transferred to a PC for analysis or an external controller can be used to control the instrument for making measurements.

**D/A Output (Option) «For procedures, see section 15.1.»**

The numerical data can be output using a  $\pm 5$  V FS DC analog voltage. Up to 30 items can be specified for normal measurement and harmonic measurement, separately.

**RGB Video Signal (VGA) Output «For procedures, see section 15.2.»**

The RGB video signal (VGA, Video Graphics Array) can be output to an external monitor. This allows values and waveforms to be displayed on a large screen.

**Initialization «For procedures, see section 15.3.»**

The settings entered using keys and soft keys can be initialized to factory default condition. For details on the initial settings, see appendix 3, "List of Initial Settings and Display Order of Numerical Data."



### **Zero-Level Compensation «For procedures, see section 15.4.»**

Zero-level compensation refers to creating a zero input condition inside the WT1600 and setting the level at that point as the zero level. Zero-level compensation must be performed in order to satisfy the specifications of this instrument (see chapter 17). Zero-level compensation is automatically performed when harmonic measurement is turned ON/OFF or the measurement range or input filter is changed. However, if the harmonic measurement ON/OFF setting, measurement range, and input filter are not changed over an extended time, the zero level may change due to the changes in the environment surrounding the instrument. In such case, you can manually perform zero-level compensation. There is also a function that performs zero-level compensation during integration.

### **NULL Function «For procedures, see section 15.5.»**

When the NULL function is turned ON, Udc and Idc (numerical data of the simple average of the voltage and current during normal measurement) are set as NULL values. The NULL value is subtracted from the sampled data of voltage and current. Hence, all measurement functions are affected by the NULL values.

### **Selecting the Message Language «For procedures, see section 15.6.»**

The language of the error messages displayed on the screen during operation can be set to English or Japanese.

### **Setting the Brightness of the Screen «For procedures, see section 15.6.»**

The brightness of the LCD monitor can be adjusted.

### **Setting the Display Colors «For procedures, see section 15.7.»**

The colors for graphical elements such as the waveform, background, scale, and cursor and text elements such as the menu and the menu background can be selected. Set the color using a ratio of red (R), green (G), and blue (B).

### **Self-Test Function «For procedures, see section 16.3.»**

A self-test can be performed to check whether the instrument is operating properly. Components such as the internal memory (ROM and RAM), the operation keys, the floppy disk drive, and the built-in printer (option) can be tested.

### **Confirming the System Condition of the Instrument «For procedures, see section 16.4.»**

The system condition of the instrument such as the model, ROM version (firmware version), input element configuration, and existence of options can be confirmed.

# 2.1 Front Panel, Rear Panel, and Top View

## Front Panel

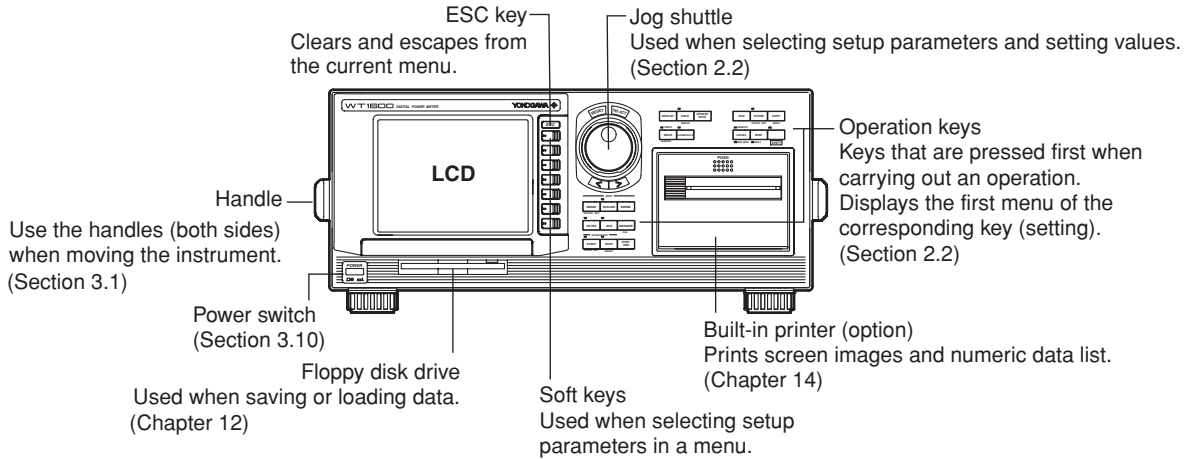

## Rear Panel

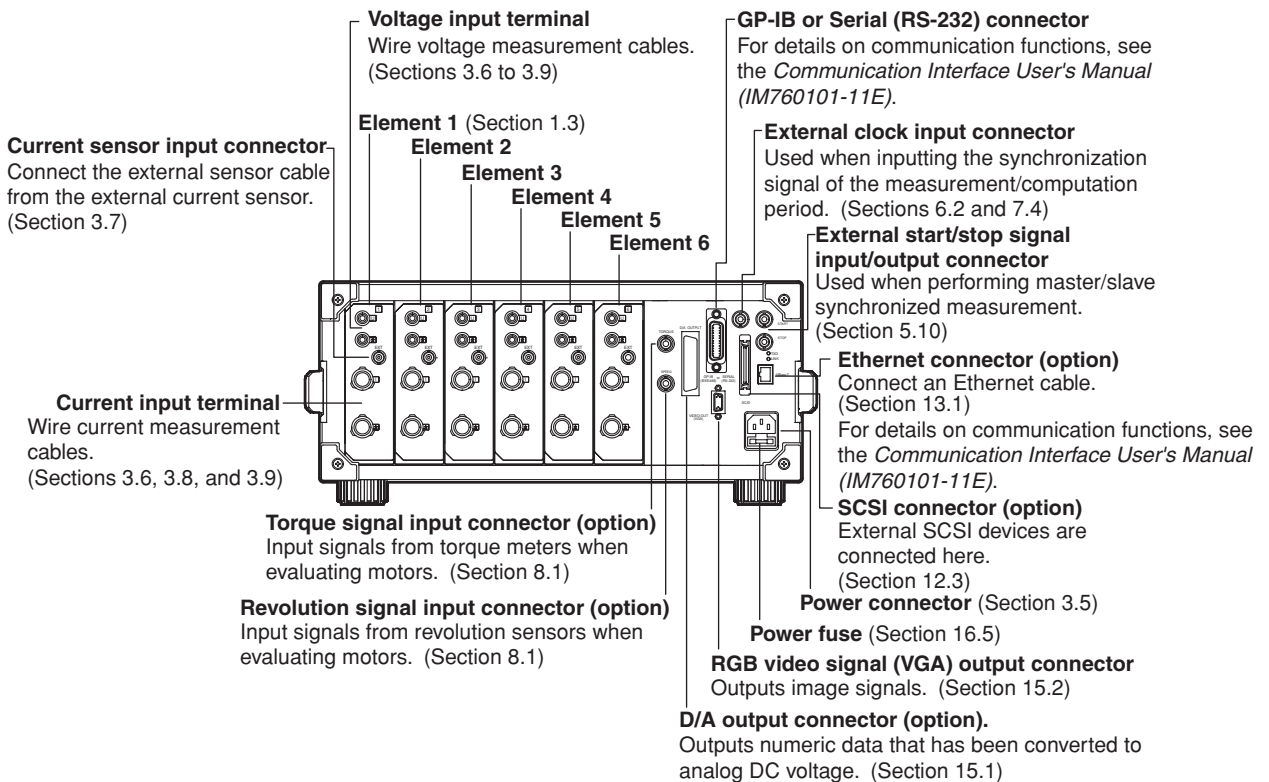

### Top View

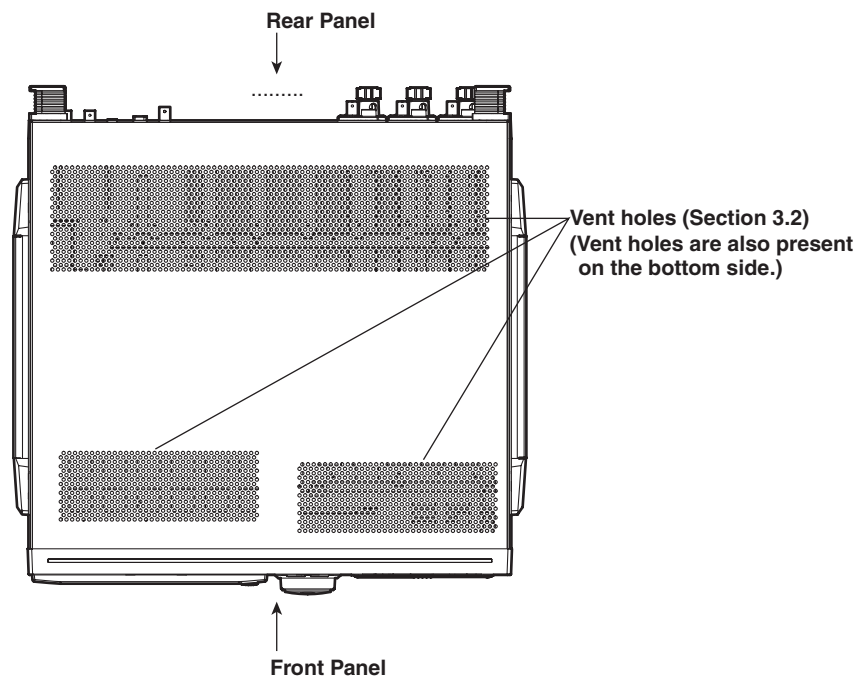

## 2.2 Operation Keys, Jog Shuttle

### Common to All Functions

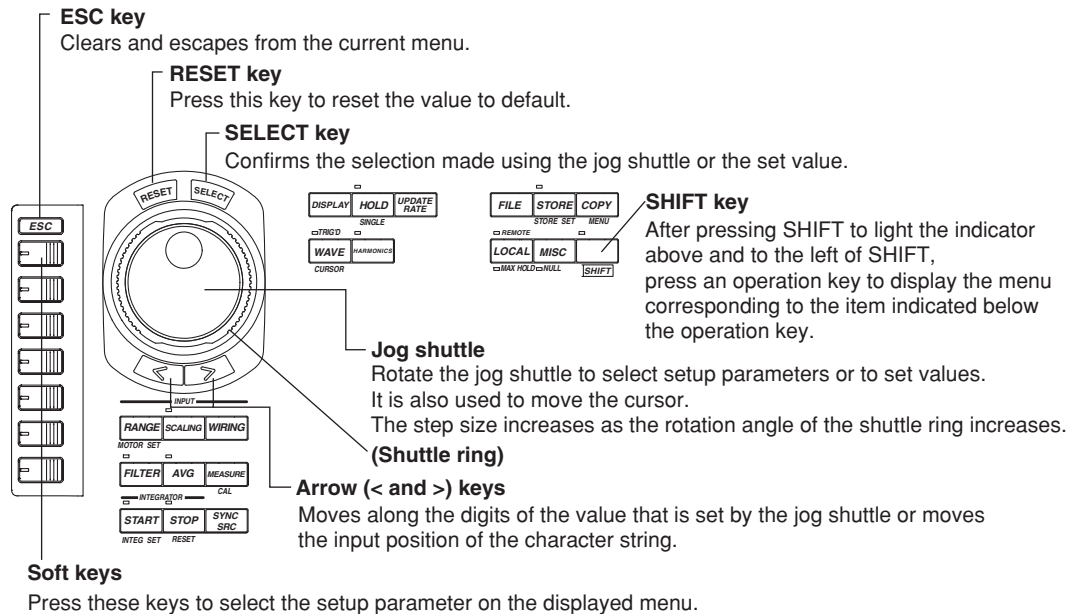

### Set Measurement Conditions and Normal Measurement Mode

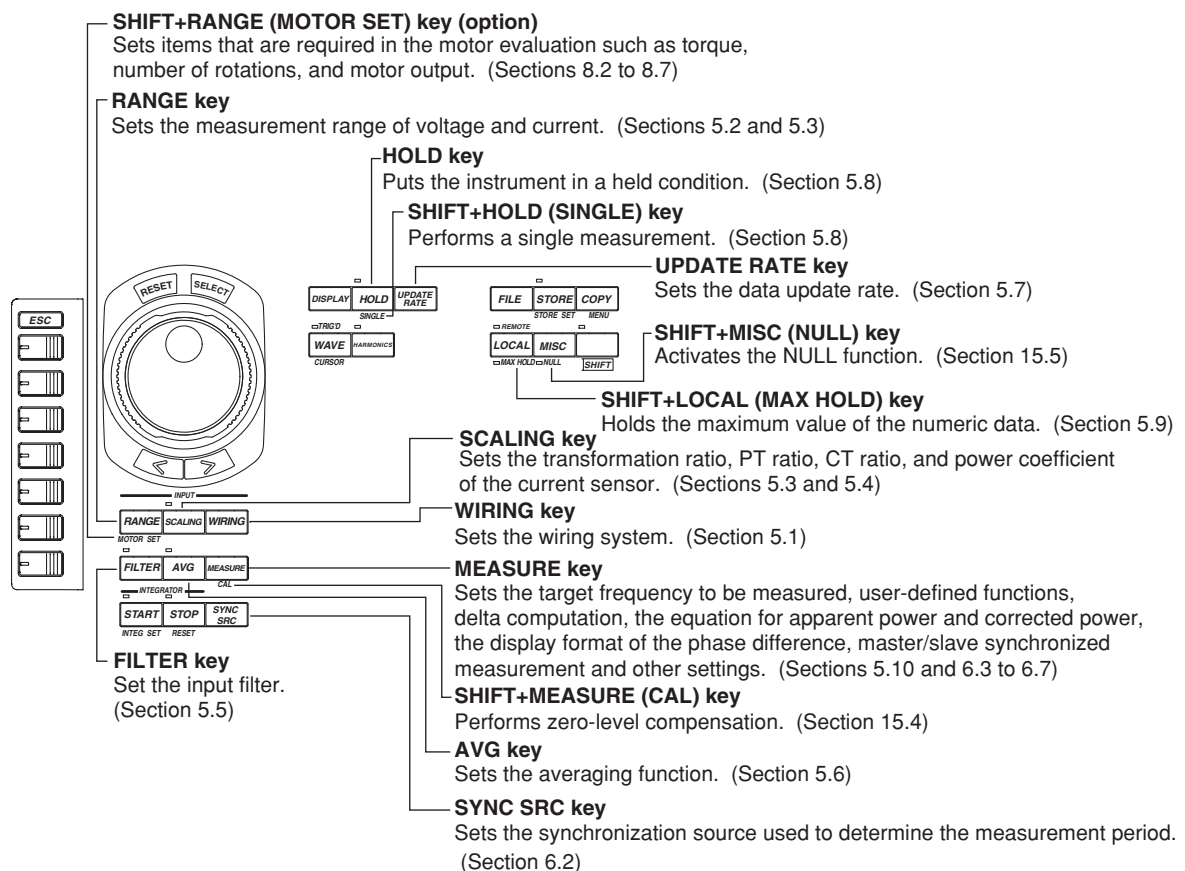

### Set Integration and Harmonics Measurement

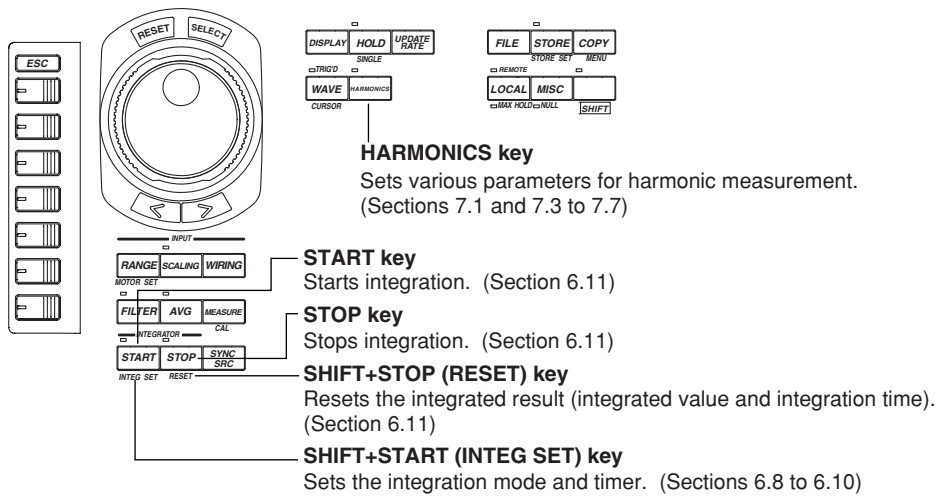

### Set the Display

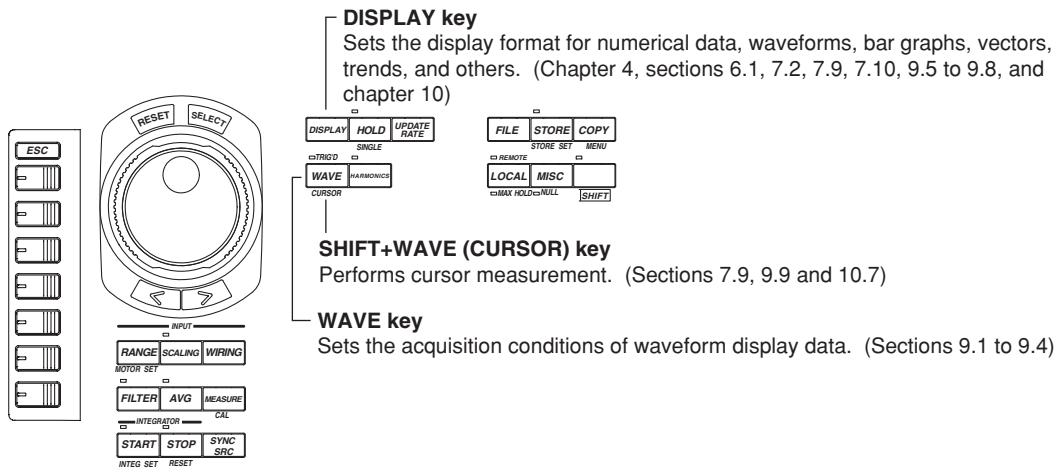

## Store and Recall Data, Save and Load Data, Set Ethernet Communications and Other Functions

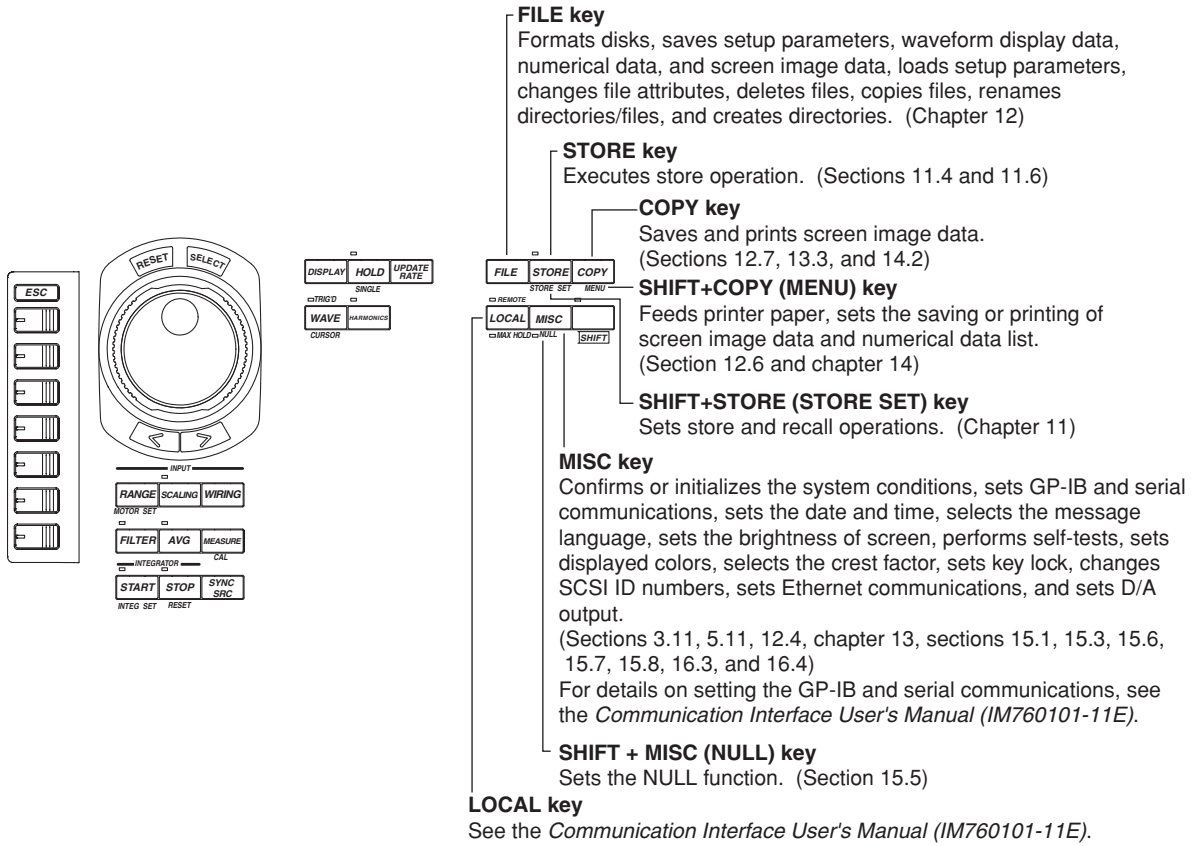

## 3.1 Precautions Concerning the Use of the Instrument

### Safety Precautions

#### Safety Precautions

If you are using this instrument for the first time, make sure to thoroughly read the "Safety Precautions" given on pages vi to vii.

#### Do Not Remove the Case

Do not remove the case from the instrument. Some sections inside the instrument have high voltages that are extremely dangerous. For internal inspection or adjustment, contact your nearest YOKOGAWA dealer.

#### Abnormal Behavior

Stop using the instrument if there are any symptoms of trouble such as strange odors or smoke coming from the instrument. If these symptoms occur, immediately turn OFF the power and unplug the power cord. In addition, turn OFF the power to the measurement circuits that are connected to the input terminals. Then, contact your nearest YOKOGAWA dealer.

#### Power Cord

Nothing should be placed on top of the power cord. The power cord should also be kept away from any heat sources. When unplugging the power cord from the outlet, never pull by the cord itself. Always hold and pull by the plug. If the power cord is damaged, check the part number indicated on page iii and purchase a replacement.

### General Handling Precautions

#### Do Not Place Objects on Top of the Instrument

Never stack the instruments or place other instruments or any objects containing water on top of the instrument. Such act can lead to malfunction.

#### Keep Electrically Charged Objects Away from the Instrument

Keep electrically charged objects away from the input terminals. They may damage the internal circuitry.

#### Do Not Damage the LCD

The LCD is very vulnerable to scratches. Therefore, be careful not to damage the surface with sharp objects. Also, do not apply vibration or shock to it.

#### When Not Using the Instrument for a Extended Time

Turn OFF the power to the measurement circuit and the instrument and remove the power cord from the outlet.

#### When Carrying the Instrument

First, turn OFF the devices under measurement and remove the measurement cables. Then, turn OFF the instrument and remove power and other cables. To carry the instrument, use the handle or carry it using both hands.

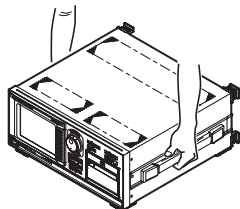

#### Cleaning

When cleaning the case or the operation panel, first turn OFF the circuit under measurement and the instrument and remove the instrument's power cord from the outlet. Then, wipe with a dry, soft cloth. Do not use volatile chemicals as this may cause discoloring and deformation.

---

## 3.2 Installing the Instrument

### Installation Conditions

Install the instrument in a place that meets the following conditions.

#### Flat, Even Surface

If the instrument is not installed on a stable horizontal surface, the printer's recording quality may degrade and precise measurements may be impeded.

#### Well-Ventilated Location

Vent holes are located on the top and bottom of the instrument. To prevent internal overheating, allow at least 20 mm of space around the vent holes.

When connecting measurement wires and other various cables or when opening or closing the built-in printer cover, allow extra space for operation.

#### Ambient Temperature and Humidity

Ambient temperature: 5 to 40°C

Ambient humidity: 20 to 80%RH (when the printer is not used)  
35 to 80%RH (when the printer is used)

No condensation in either case.

#### Do Not Install the Instrument in the Following Places:

- In direct sunlight or near heat sources.
- Where an excessive amount of soot, steam, dust, or corrosive gas is present.
- Near strong magnetic field sources.
- Near high voltage equipment or power lines.
- Where the level of mechanical vibration is high.
- In an unstable place.

#### Note

- For the most accurate measurements, use the instrument in the following environment.  
Ambient temperature: 23±3°C Ambient humidity: 30 to 75%RH (no condensation)  
When using the instrument in a place where the ambient temperature is 5 to 20°C or 26 to 40°C, add the temperature coefficient to the accuracy as specified in chapter 17.
  - When installing the instrument in a place where the ambient humidity is 30% or below, take measures to prevent static electricity such as using an anti-static mat.
  - Condensation may occur if the instrument is moved to another place where the ambient temperature is higher, or if the temperature changes rapidly. In this case, let the instrument adjust to the new environment for at least an hour before using the instrument.
- 

### Storage Location

When storing the instrument, avoid the following places:

- Where the relative humidity is 80% or more.
- In direct sunlight.
- Where the temperature is 60°C or higher.
- Near a high humidity or heat source.
- Where the level of mechanical vibration is high.
- Where corrosive or explosive gas is present.
- Where an excessive amount of soot, dust, salt, and iron are present.
- Where water, oil, or chemicals may splash.

It is recommended that the instrument be stored in an environment where the temperature is between 5 and 40°C and the relative humidity is between 20 and 80%.



## Installation Position

### Desktop

Place the instrument on a flat, even surface as shown in the figure below. If the instrument is installed in a horizontal position, rubber feet can be attached to prevent slipping. Two sets (four pieces) of rubber feet are included in the package.

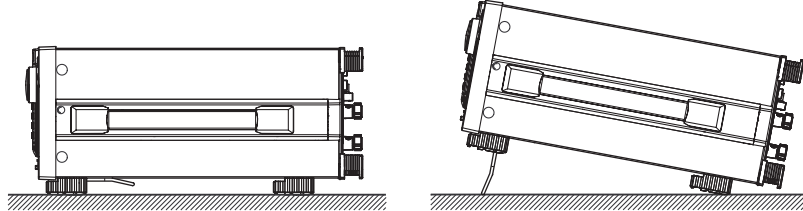

### Rack Mount

To rack mount the instrument, use the rack mount kit that is sold separately.

Name	Model	Notes
Rack mount kit	751535-E4	For EIA
Rack mount kit	751535-J4	For JIS

An outline of the attachment procedures is given below. For details regarding the attachment procedures, see the instructions that are included with the rack mount kit.

1. Remove the handles on both sides of the instrument.
2. Remove the four feet on the bottom of the instrument.
3. Remove the two plastic rivets and the four seals covering the rack mount attachment holes on both sides of the instrument near the front.
4. Places seals over the feet and handle attachment holes.
5. Attach the rack mount kit.
6. Mount the instrument on the rack.

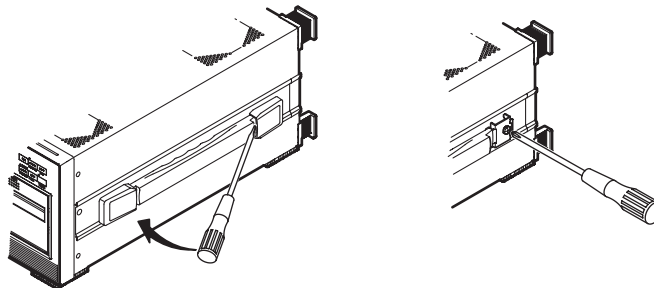

### Note

- When rack mounting the instrument, allow at least 20 mm of space around the vent holes to prevent internal overheating.
- Make sure to have adequate support for the bottom of the instrument. However, do not block the vent holes in the process.

---

## 3.3 Wiring Precautions

To prevent the possibility of electric shock and damage to the instrument, follow the warnings below.



---

### WARNING

- Employ protective earth ground before connecting measurement cables.
- Turn OFF the power to the measurement circuit, when wiring the circuit. Connecting or removing measurement cables while the power is turned ON is dangerous.
- Take special caution not to wire a current circuit to the voltage input terminal or a voltage circuit to the current input terminal.
- Strip the insulation cover of the measurement cable so that when it is wired to the input terminal, the conductive parts (bare wires) do not protrude from the terminal. Also, make sure to fasten the input terminal screws securely so that the cable does not come loose.
- Use cables with safety terminals that cover the conductive parts for connecting to the voltage input terminals. Using a terminal with bare conductive parts (such as a banana plug) is dangerous when the terminal comes loose.
- Use cables with safety terminals that cover the conductive parts for connecting to the current sensor input terminals. Using a terminal with bare conductive parts is dangerous when the terminal comes loose.
- When the voltage of the circuit under measurement is being applied to the current input terminals, do not touch the current sensor input terminals. Since these terminals are electrically connected inside the instrument, this act is dangerous.
- When connecting measurement cables from an external current sensor to the current sensor input connector, remove the cables connected to the current input terminals. In addition, when the voltage of the circuit under measurement is being applied to the current sensor input terminal, do not touch the current input terminals. Since these terminals are electrically connected inside the instrument, this act is dangerous.
- When using the external potential transformer (PT) or current transformer (CT), make sure it has enough withstand voltage with respect to the voltage (U) being measured ( $2U + 1000$  V recommended). Also, make sure that the secondary side of the CT does not become an open circuit while the power is being applied. Otherwise, high voltage will appear at the secondary side of the CT, making it extremely dangerous.
- When using an external current sensor, make sure to use a sensor that comes in a case. The conductive parts and the case should be insulated, and the sensor should have enough withstand voltage with respect to the voltage being measured. Using a bare sensor is dangerous, because you might accidentally come in contact with it.
- When using a shunt-type current sensor as an external current sensor, turn OFF the circuit under measurement. Connecting or removing a sensor while the power is ON is dangerous.
- When using a clamp-type current sensor as an external current sensor, have a good understanding of the voltage of the circuit under measurement and the specifications and handling of the clamp-type sensor. Then, confirm that there are no shock hazards.
- For safety reasons, when using the instrument on a rack mount, furnish a switch for turning OFF the circuit under measurement from the front side of the rack.
- After connecting the measurement cable, attach the current input protection cover using the 4 screws provided for your safety. Make sure that the conductive parts are not exposed from the protection cover.

- To make the protective functions effective, check the following items before applying the voltage or current of the circuit under measurement.
  - The power cable provided with the instrument is used to connect to the power supply and the instrument is grounded.
  - The power switch of the instrument is turned ON.
  - The current input protective cover provided with the instrument is being used.
- When the power switch of the instrument is turned ON, do not apply a signal that exceeds the following values to the voltage or current input terminals. When the instrument is turned OFF, turn OFF the circuit under measurement. For other input terminals, see the specifications of each module in chapter 17.

#### Instantaneous Maximum Allowable Input (1 cycle, for 20 ms)

##### Voltage Input

Peak value of 4000 V or RMS value of 1500 V, whichever is less.

##### Current Input

###### 5-A input element

Peak value of 30 A or RMS value of 15 A, whichever is less.

###### 50-A input element

Peak value of 450 A or RMS value of 300 A, whichever is less.

#### Continuous Maximum Allowable Input

##### Voltage Input

Peak value of 1500 V or RMS value of 1000 V, whichever is less.

##### Current Input

###### 5-A input element

Peak value of 10 A or RMS value of 7 A, whichever is less.

###### 50-A input element

Peak value of 150 A or RMS value of 50 A, whichever is less.



### CAUTION

- Use measurement cables that have adequate margins of withstand voltage and current capacity with respect to the voltage or current being measured. It should also have proper ratings that are suited to the measurement.  
Example: When making measurements on a current of 20 A, use copper wires that have a conductive cross-sectional area of 4 mm<sup>2</sup>.
- When the measurement cable is connected, it may cause radio interference in which case the user may be required to take adequate measures.

#### Note

- After wiring, the wiring system must be selected. See section 5.1, "Selecting the Wiring System."
- When measuring large currents or voltages or currents that contain high frequency components, take special care in dealing with mutual interference and noise when wiring.
- Keep the measurement cables as short as possible to minimize the loss between the circuit under measurement and the instrument.
- The thick lines on the wiring diagrams shown in sections 3.6 and 3.9 are the sections where the current flows. Use appropriate wires that are suitable for the current.
- In order to make accurate measurements of the voltage of the circuit under measurement, connect the cable to the circuit as close as possible.
- In order to make correct measurements, separate the measurement cables as far away from the earth ground wires and the instrument's case as possible to minimize the static capacitance to earth ground.
- To more accurately measure apparent power and power factor in three-phase unbalanced circuits, we recommend the three-voltage three-current (3V3A) measurement method.

## 3.4 For Making Accurate Measurements

### Effects of Power Loss

By using an appropriate wiring system that matches the load, the effects of power loss on measurement accuracy can be minimized. We will consider the current source (SOURCE) and load resistance (LOAD) below.

- **When the Measurement Current Is Relatively Large**

Wire so that the voltage measurement circuit is connected to the load side. The current measurement circuit measures the sum of current  $i_L$  flowing through the load of the circuit under measurement and the current  $i_V$  flowing through the voltage measurement circuit. Because the current flowing through the circuit under measurement is  $i_L$ ,  $i_V$  is the amount of error. The input resistance of the voltage measurement circuit of the instrument is approximately  $2\text{ M}\Omega$ . If the input is  $1000\text{ V}$ ,  $i_V$  is approximately  $0.5\text{ mA}$  ( $1000\text{ V}/2\text{ M}\Omega$ ). If the load current,  $i_L$ , is  $5\text{ A}$  or more (load resistance is  $200\ \Omega$  or less), then the effect of  $i_V$  on the measurement is  $0.01\%$  or less. If the input is  $100\text{ V}$  and  $5\text{ A}$ ,  $i_V = 0.05\text{ mA}$  ( $100\text{ V}/2\text{ M}\Omega$ ) then the effect of  $i_V$  on the measurement accuracy is  $0.001\%$  ( $0.05\text{ mA}/5\text{ A}$ ).

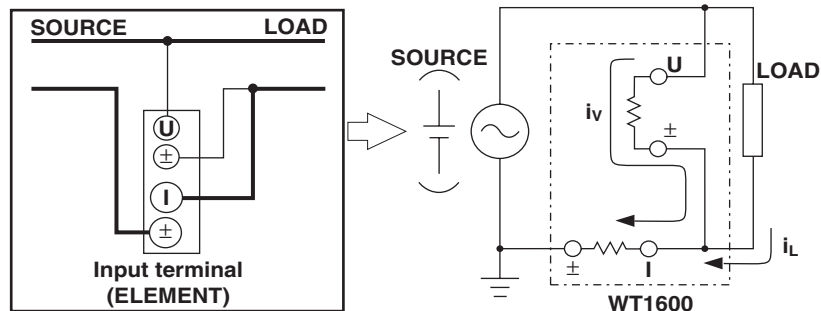

As a reference, the relationship of the voltages and currents that produce effects of  $0.1\%$ ,  $0.01\%$ , and  $0.001\%$  are shown in the figure below.

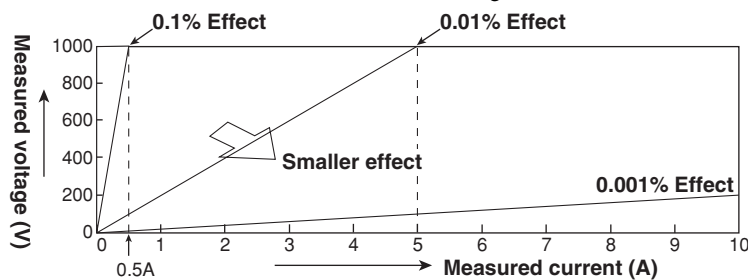

- **When the Measurement Current Is Relatively Small**

Wire so that the current measurement circuit is connected to the load side. In this case, the voltage measurement circuit measures the sum of the load voltage  $e_L$  and voltage drop  $e_I$  across the current measurement circuit.  $e_I$  is the amount of error in this case. The input resistance of the current measurement circuit of the instrument is  $100\text{ m}\Omega$  and  $2\text{ m}\Omega$  for the  $5\text{-A}$  and  $50\text{-A}$  input terminals, respectively. For example, if the load resistance is  $1\text{ k}\Omega$ , then the effects on the measurement accuracy is  $0.01\%$  for the  $5\text{-A}$  input terminal ( $100\text{ m}\Omega/1\text{ k}\Omega$ ) and  $0.0002\%$  for the  $50\text{-A}$  input terminal ( $2\text{ m}\Omega/1\text{ k}\Omega$ ).

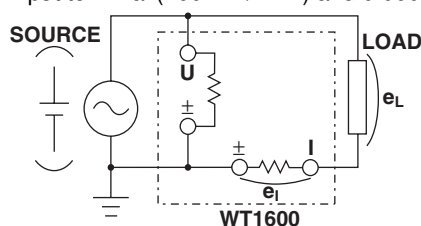

**Effects of Stray Capacitance**

The effects of stray capacitance on the measurement accuracy can be minimized by connecting the current input terminal of the instrument to the side that is close to the earth potential of the power source (SOURCE).

The internal structure of the instrument is as follows. The voltage and current measurement circuits are each enclosed in shielded cases. These shielded cases are placed inside the outer case. The shielded case of the voltage measurement circuit is connected to the ± terminal of the voltage input terminal and the shielded case of the current measurement circuit is connected to the ± terminal of the current input terminal. Because the outer case is insulated from the shielded case, stray capacitance  $C_s$  of approximately 100 pF exists. The current generated by this stray capacitance,  $C_s$ , will cause errors.

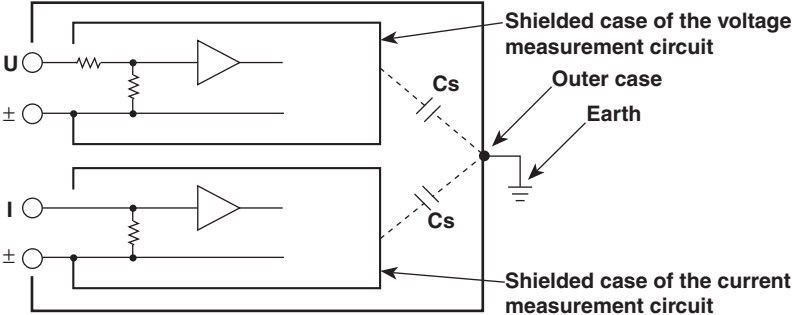

For example, we will consider the case when one side of the power source and the outer case are grounded.

In this case, two current flows can be considered, load current  $i_L$  and the current that flows through the stray capacitance  $i_{C_s}$ .  $i_L$  flows through the current measurement circuit, then through the load, and returns to the power source (shown with a dotted line).  $i_{C_s}$  flows through the current measurement source, through the stray capacitance, and then through the earth ground of the outer case, and returns to the power source (shown with a dot-dash line).

Therefore, the current measurement circuit ends up measuring the sum of  $i_L$  and  $i_{C_s}$  even though it wants to measure only  $i_L$ .  $i_{C_s}$  is the amount of error in this case. If the voltage applied to  $C_s$  is  $V_{C_s}$  (common mode voltage), then  $i_{C_s}$  can be found using the following equation. Because the phase of  $i_{C_s}$  is ahead of the voltage by  $90^\circ$  the effects of  $i_{C_s}$  on the measurement accuracy increases as the power factor gets smaller.

$$i_{C_s} = V_{C_s} \times 2\pi f \times C_s$$

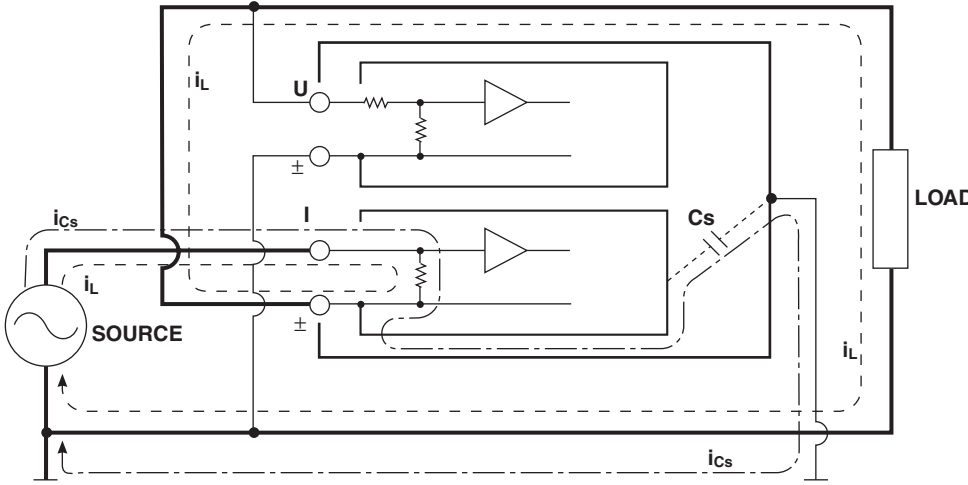

When measuring high frequencies as in this instrument, this error,  $i_{C_s}$ , cannot be ignored. By connecting the current input terminal of the instrument to the side that is close to the earth potential of the power source (SOURCE), the terminal of the current measurement circuit of the instrument approaches the earth potential. Thus,  $V_{C_s}$  becomes approximately zero and very little  $i_{C_s}$  flows.

## 3.5 Connecting the Power Supply

### Before Connecting the Power

To prevent the possibility of electric shock and damage to the instrument, follow the warnings below.



### WARNING

- Connect the power cord only after confirming that the voltage of the power supply matches the rated electric power voltage for the instrument.
- Connect the power cord after checking that the power switch of the instrument is turned OFF.
- To prevent the possibility of electric shock or fire, always use the power cord supplied by YOKOGAWA.
- Make sure to perform protective grounding to prevent the possibility of electric shock. Connect the power cord to a three-pin power outlet with a protective earth terminal.
- Do not use an extension cord without protective earth ground. Otherwise, the protection function will be compromised.
- Use a power outlet compatible with the accessory power cord and ensure proper protective grounding. Do not use the instrument if no such compatible power outlet and proper protective grounding are available.

### Connecting the Power Cord

1. Check that the power switch is OFF.
2. Connect the power cord plug to the power connector on the rear panel. (Use the power cord that came with the package.)
3. Connect the plug on the other end of the power cord to the outlet that meets the conditions below. The AC outlet must be of a three-pin type with a protective earth ground terminal.

Item	Specification
Rated supply voltage	100 to 120 VAC, 200 to 240 VAC
Permitted supply voltage range	90 to 132 VAC, 180 to 264 VAC
Rated supply voltage frequency	50/60 Hz
Permitted supply voltage frequency range	48 to 63 Hz
Maximum power consumption (when using the printer)	150 VA

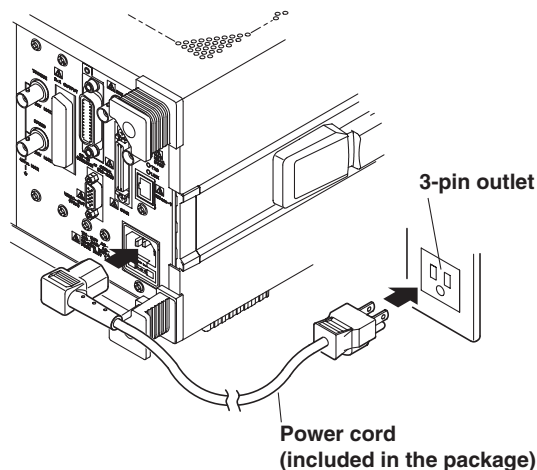

## 3.6 Directly Wiring the Circuit under Measurement

The measurement cable is wired directly from the circuit under measurement to the voltage/current input terminal.

To prevent the possibility of electric shock and damage to the instrument, follow the precautions given in section 3.3, "Wiring Precautions."

### Connecting to the Input Terminal

- **Voltage Input Terminal**

The terminal is a  $\phi 4$ -mm safety banana jack (female).

Insert the safety terminal (the conductive parts are not exposed) into the voltage input terminal.

- **Current Input Terminal**

- When the voltage of the circuit under measurement is being applied to the current input terminals, do not touch the current sensor input terminals. Since these terminals are electrically connected inside the instrument, this act is dangerous.

- When connecting measurement cables from an external current sensor to the current sensor input connector, remove the cables connected to the current input terminals. In addition, when the voltage of the circuit under measurement is being applied to the current sensor input terminal, do not touch the current input terminals. Since these terminals are electrically connected inside the instrument, this act is dangerous.

- The terminal is a binding post. The screws used on the terminal (binding post) are M6 screws. Either wind the wire around the screw or pass the crimp-on lugs through the screw axis, then tighten firmly by holding the terminal knob.

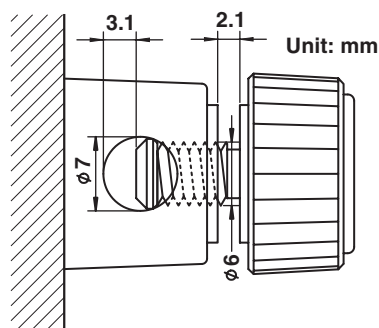

### Number of Installed Input Elements and Wiring Systems

The selectable wiring systems vary depending on the number of input elements that are installed in the instrument. You may be able to select only a single type of wiring system or two or three types of wiring systems. For details, see "Number of Installed Input Elements and Wiring Systems" in section 1.3, "Measurement Conditions."

### 3.6 Directly Wiring the Circuit under Measurement

**Note**

- After wiring, the wiring system must be selected. See section 5.1, “Selecting the Wiring System.”
- The thick lines on the wiring diagrams are the sections where the current flows. Use appropriate wires that are suitable for the current.

#### Wiring Example of a Single-Phase, Two-Wire System (1P2W)

If there are six input elements, six single-phase, two-wire systems can be set up.

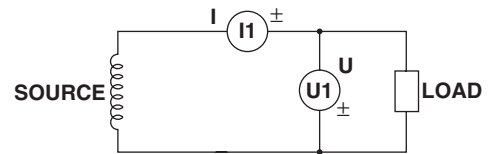
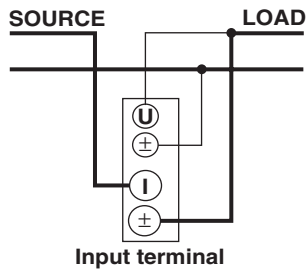
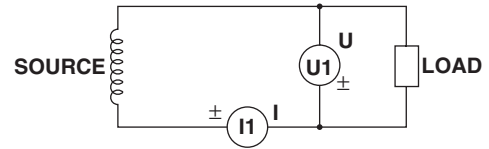
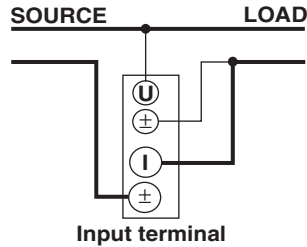

#### Wiring Example of a Single-Phase, Three-Wire System (1P3W)

- If there are six input elements, three single-phase, three-wire systems can be set up (elements 1 and 2, elements 3 and 4, and elements 5 and 6).
- The assignment of elements to the input terminals in the figure varies depending on the number of installed input elements. For details, see “Number of Installed Input Elements and Wiring Systems” in section 1.3, “Measurement Conditions.”

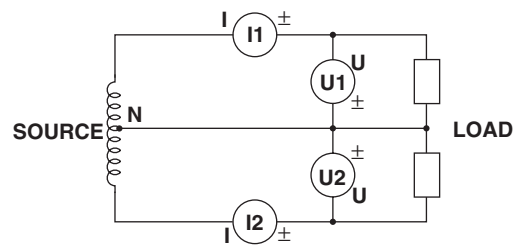
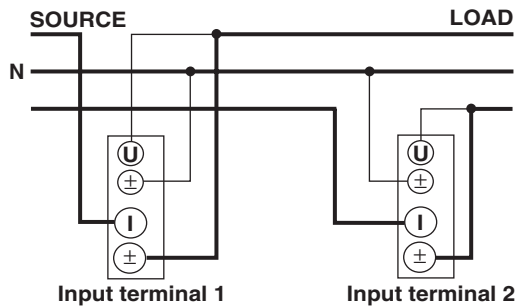



### Wiring Example of a Three-Phase, Three-Wire System (3P3W)

- If there are six input elements, three three-phase, three-wire systems can be set up (elements 1 and 2, elements 3 and 4, and elements 5 and 6).
- The assignment of elements to the input terminals in the figure varies depending on the number of installed input elements. For details, see “Number of Installed Input Elements and Wiring Systems” in section 1.3, “Measurement Conditions.”

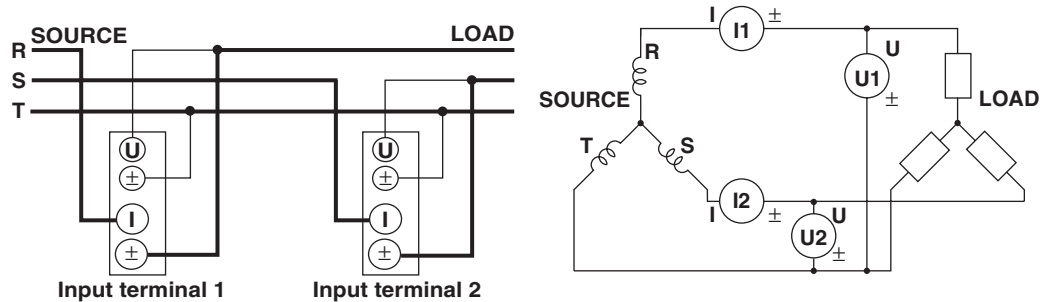

### Wiring Example of a Three-Voltage, Three-Current System (3V3A)

- If there are six input elements, two three-voltage, three-current systems can be set up (elements 1, 2, and 3 and elements 4, 5, and 6).
- The assignment of elements to the input terminals in the figure varies depending on the number of installed input elements. For details, see “Number of Installed Input Elements and Wiring Systems” in section 1.3, “Measurement Conditions.”

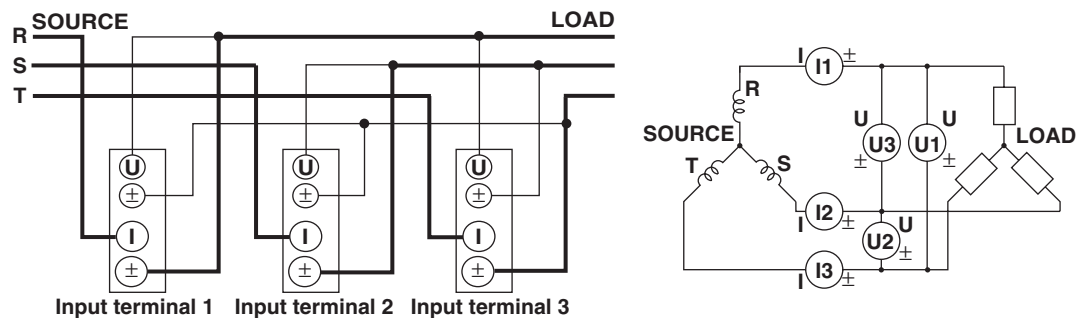

### Wiring Example of a Three-Phase, Four-Wire System (3P4W)

- If there are six input elements, two three-phase, four-wire systems can be set up (elements 1, 2, and 3 and elements 4, 5, and 6).
- The assignment of elements to the input terminals in the figure varies depending on the number of installed input elements. For details, see “Number of Installed Input Elements and Wiring Systems” in section 1.3, “Measurement Conditions.”

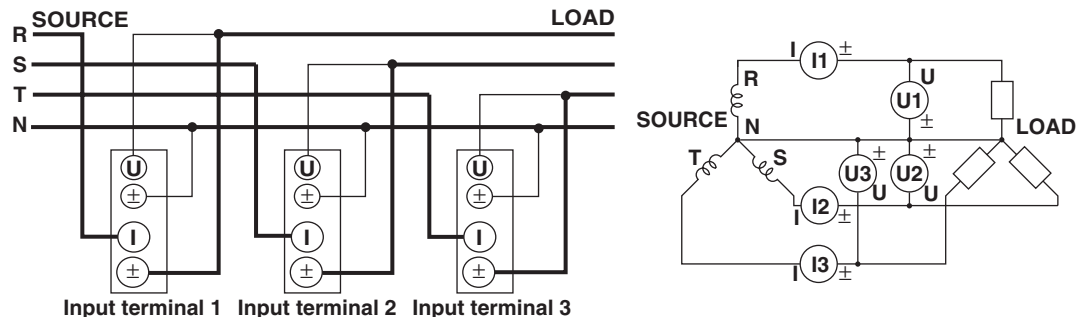

#### Note

For the relationship between the wiring systems and the method of determining the measured values or computed values, see Appendix 1, “Symbols and Determination of Measurement Functions.”

---

## 3.7 Using an External Current Sensor to Wire the Circuit under Measurement

To prevent the possibility of electric shock and damage to the instrument, follow the precautions given in section 3.3, "Wiring Precautions."

- As shown below, when the maximum current value of the circuit under measurement exceeds the maximum range of the input element, an external sensor can be connected to the current sensor input connector in order to measure the current of the circuit under measurement.
  - 5-A input element  
When the maximum current exceeds "5 Arms."
  - 50-A input element  
When the maximum current exceeds "50 Arms."
- A shunt-type or clamp-type current sensor can be used for an external current sensor.

### Connecting to the Current Sensor Input Connector

Connect an external sensor cable with the BNC connector (B9284LK, sold separately) to the current sensor input connector.

When connecting the external sensor cable, remove the measurement cable from the current input terminal. Since the current sensor input connector and the current input connector are connected internally, measurement inaccuracies or malfunction could result. In addition, when the voltage of the circuit under measurement is being applied to the current sensor input terminals, do not touch the other current input terminals or current sensor terminals. Since these terminals are electrically connected inside the instrument, doing so can be dangerous.

### Number of Installed Input Elements and Wiring Systems

The selectable wiring systems vary depending on the number of input elements that are installed in the instrument. You may be able to select only a single type of wiring system or two or three types of wiring systems. For details, see "Number of Installed Input Elements and Wiring Systems" in section 1.3, "Measurement Conditions."

### 3.7 Using an External Current Sensor to Wire the Circuit under Measurement

#### Note

- After wiring, the wiring system must be selected. See section 5.1, “Selecting the Wiring System.”
- The thick lines on the wiring diagrams are the sections where the current flows. Use appropriate wires that are suitable for the current.
- To more accurately measure apparent power and power factor in three-phase unbalanced circuits, we recommend the three-voltage three-current (3V3A) measurement method.
- The current sensor input transformation function can be used to transform the input signal to data that correspond to direct measurements. For the procedures, see section 5.3, “Setting the Measurement Range When Using an External Current Sensor.”
- Note that the frequency and phase characteristics of the external current sensor affect the measured data.
- Make sure you have the polarities correct when making the connections. Otherwise, the polarity of the measurement current will be reversed and correct measurements cannot be made. Be especially careful when connecting the clamp type current sensor, because it is easy to reverse the connection.
- To minimize error when using a shunt-type current sensor, note the following points when connecting the external sensor cable.
  - Connect the shielded wire of the external sensor cable to the L side of the shunt output terminal (OUT).
  - Minimize the area created between the wires connecting the current sensor to the external sensor cable. The effects due to the line of magnetic force (caused by the measurement current) and noise that enter this area of space can be reduced.

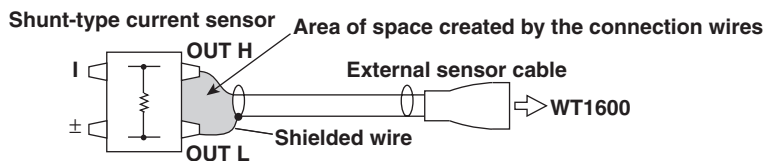

- For a shunt-type current sensor, connect it to the power earth ground side as shown in the figure below. If you have to connect the sensor to the non-earth side, use a wire that is thicker than AWG18 (conductive cross-sectional area of approx. 1 mm<sup>2</sup>) between the sensor and the instrument to reduce the effects of common mode voltage. Take safety and error reduction in consideration when constructing an external sensor cable.

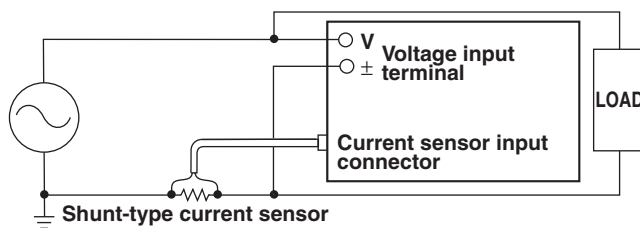

- When the circuit under measurement is not grounded and the signal is high in frequency or large in power, the effects of the inductance of the connection cable for the shunt-type current sensor become large. In these cases, use an isolation sensor (CT, DC-CT, or clamp) for the measurements.

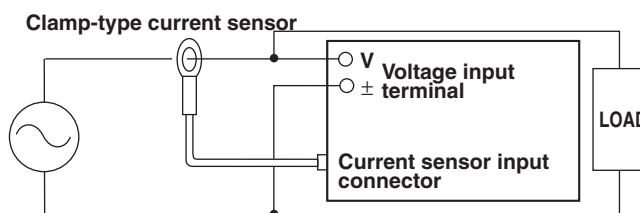

### 3.7 Using an External Current Sensor to Wire the Circuit under Measurement

The following wiring examples are for connecting shunt-type current sensors. When connecting a clamp-type current sensor, replace the shunt-type current sensor with the clamp-type. In addition, the assignment of elements to the input terminals in the following figure varies depending on the number of installed input elements. For details, see “Number of Installed Input Elements and Wiring Systems” in section 1.3, “Measurement Conditions.”

#### Wiring Example of a Single-Phase, Two-Wire System (1P2W) Using a Shunt-Type Current Sensor

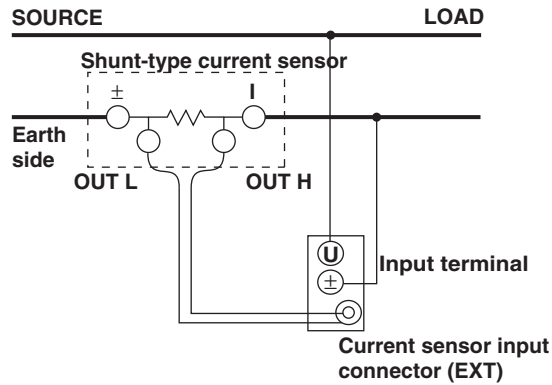

#### Wiring Example of a Single-Phase, Three-Wire System (1P3W) Using a Shunt-Type Current Sensor

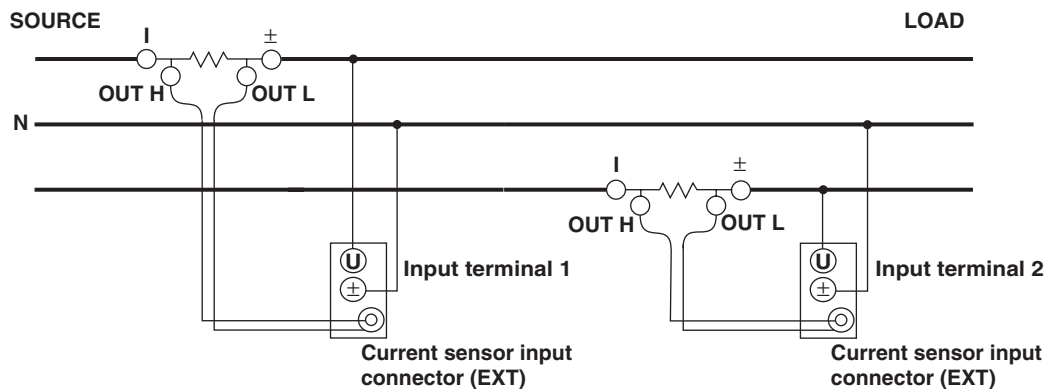

#### Wiring Example of a Three-Phase, Three-Wire System (3P3W) Using a Shunt-Type Current Sensor

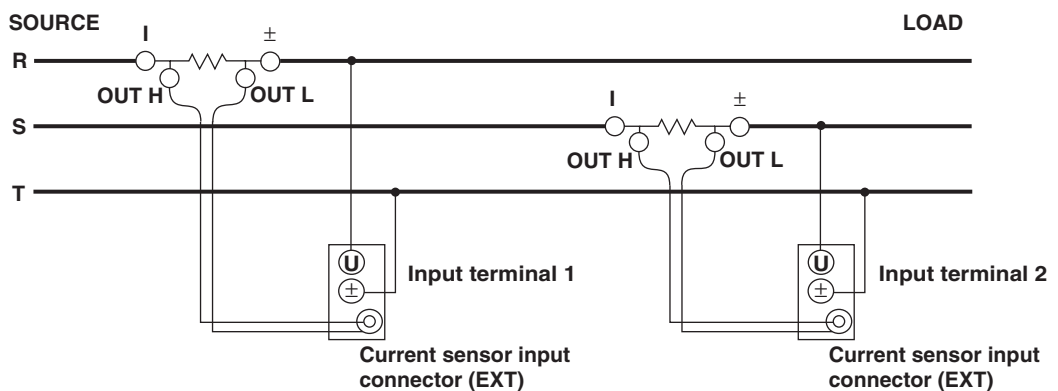

**Wiring Example of a Three-Voltage, Three-Current System (3V3A) Using a Shunt-Type Current Sensor**

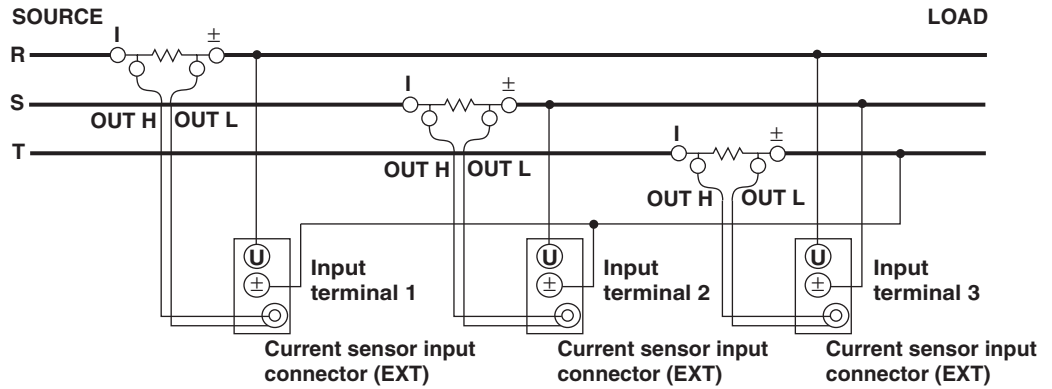

**Wiring Example of a Three-Phase, Four-Wire System (3P4W) Using a Shunt-Type Current Sensor**

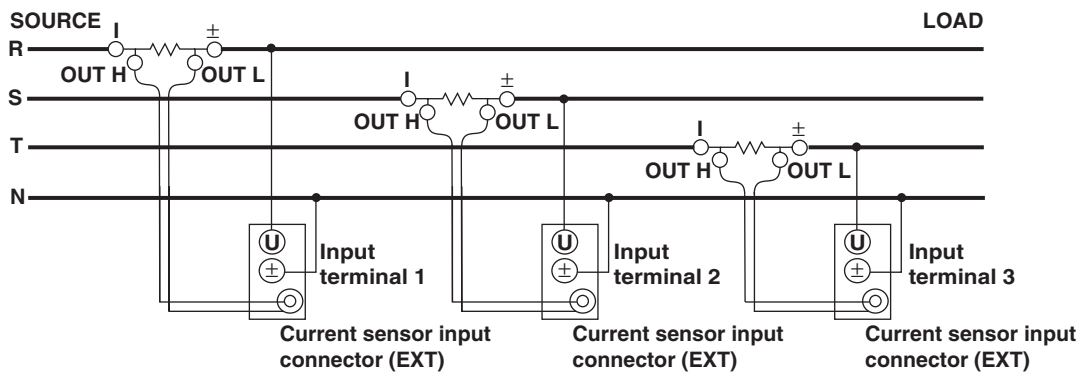

**Note**

For the relationship between the wiring systems and the method of determining the measured values or computed values, see Appendix 1, "Symbols and Determination of Measurement Functions."

---

## 3.8 Using an External PT or CT to Wire the Circuit under Measurement

Connect a measurement cable from an external potential transformer (PT) or current transformer (CT) to the voltage or current input terminal of the input element.

To prevent the possibility of electric shock and damage to the instrument, follow the precautions given in section 3.3, "Wiring Precautions."

- An external PT can be used to make measurements when the maximum voltage of the circuit under measurement exceeds "1000 Vrms."
- An external CT can be used to make measurements when the maximum current of the circuit under measurement exceeds the maximum range of the input element as shown below.
  - 5-A input element  
When the maximum current exceeds "5 Arms."
  - 50-A input element  
When the maximum current exceeds "50 Arms."

### Connecting to the Input Terminal

- **Voltage input terminal**  
Insert the safety terminal (the conductive parts are not exposed) into the voltage input terminal.
- **Current input terminal**
  - When the voltage of the circuit under measurement is being applied to the current input terminals, do not touch the current sensor input terminals. Since these terminals are electrically connected inside the instrument, this act is dangerous.
  - When connecting measurement cables from an external current sensor to the current sensor input connector, remove the cables connected to the current input terminals. In addition, when the voltage of the circuit under measurement is being applied to the current sensor input terminal, do not touch the current input terminals. Since these terminals are electrically connected inside the instrument, this act is dangerous.
  - The screws used on the terminal (binding post) are M6 screws. Either wind the wire around the screw or pass the crimp-on lugs through the screw axis, then tighten firmly by holding the terminal knob.

### Number of Installed Input Elements and Wiring Systems

The selectable wiring systems vary depending on the number of input elements that are installed in the instrument. You may be able to select only a single type of wiring system or two or three types of wiring systems. For details, see "Number of Installed Input Elements and Wiring Systems" in section 1.3, "Measurement Conditions."

**Note**

- After wiring, the wiring system must be selected. See section 5.1, “Selecting the Wiring System.”
- The thick lines on the wiring diagrams are the sections where the current flows. Use appropriate wires that are suitable for the current.
- The scaling function can be used to transform the input signal to data that correspond to direct measurements. For the procedures, see section 5.4, “Setting the Scaling Function when using an External PT or CT.”
- Note that the frequency and phase characteristics of the PT or CT affect the measured data.
- This section includes wiring diagrams that show, for safety purposes, the grounding of the secondary common terminals (+/-) for PT and CT.
- To more accurately measure apparent power and power factor in three-phase unbalanced circuits, we recommend the three-voltage three-current (3V3A) measurement method.

The assignment of elements to the input terminals in the following figure varies depending on the number of installed input elements. For details, see “Number of Installed Input Elements and Wiring Systems” in section 1.3, “Measurement Conditions.”

**Wiring Example of a Single-Phase, Two-Wire System (1P2W) Using PT and CT**

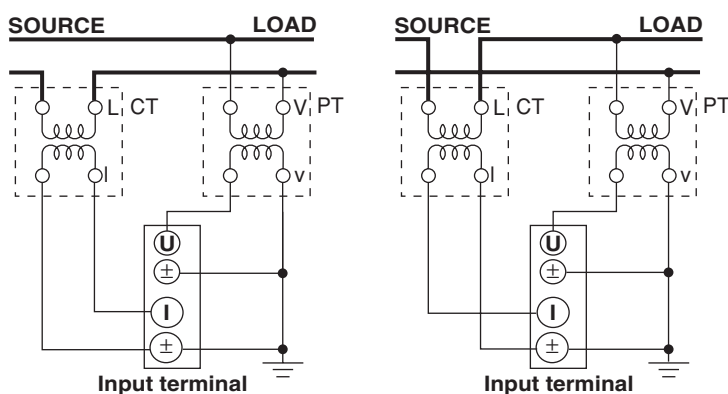

**Wiring Example of a Single-Phase, Three-Wire System (1P3W) Using PT and CT**

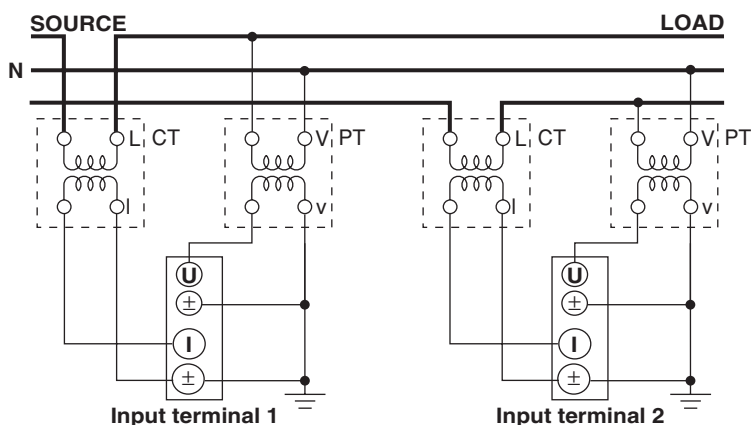

### 3.8 Using an External PT or CT to Wire the Circuit under Measurement

#### Wiring Example of a Three-Phase, Three-Wire System (3P3W) Using PT and CT

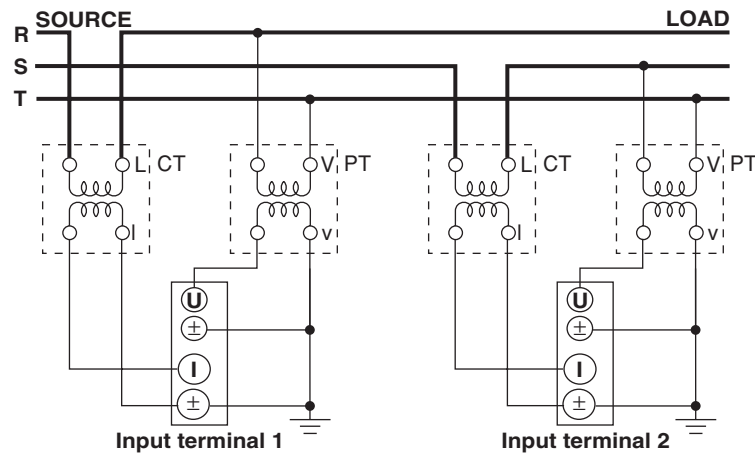

#### Wiring Example of a Three-Voltage, Three-Current System (3V3A) Using PT and CT

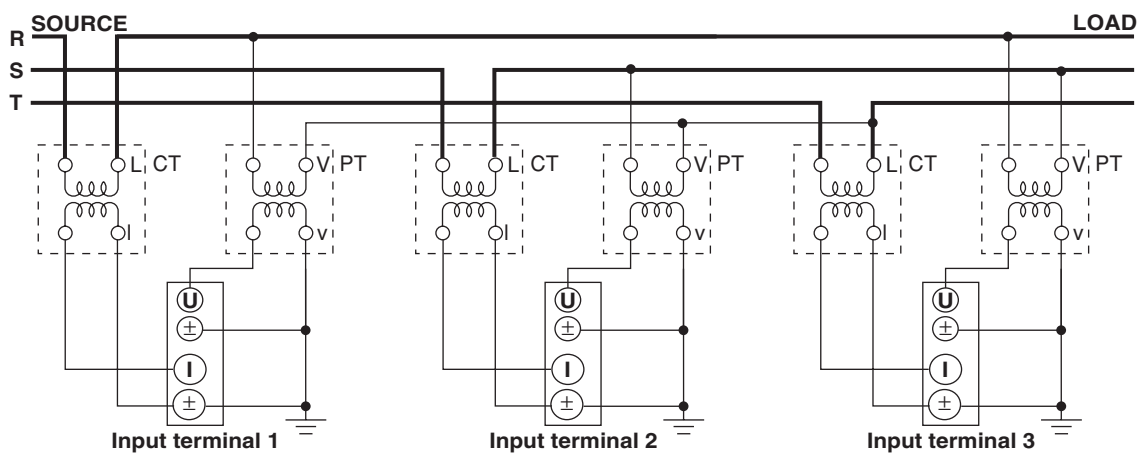

#### Wiring Example of a Three-Phase, Four-Wire System (3P4W) Using PT and CT

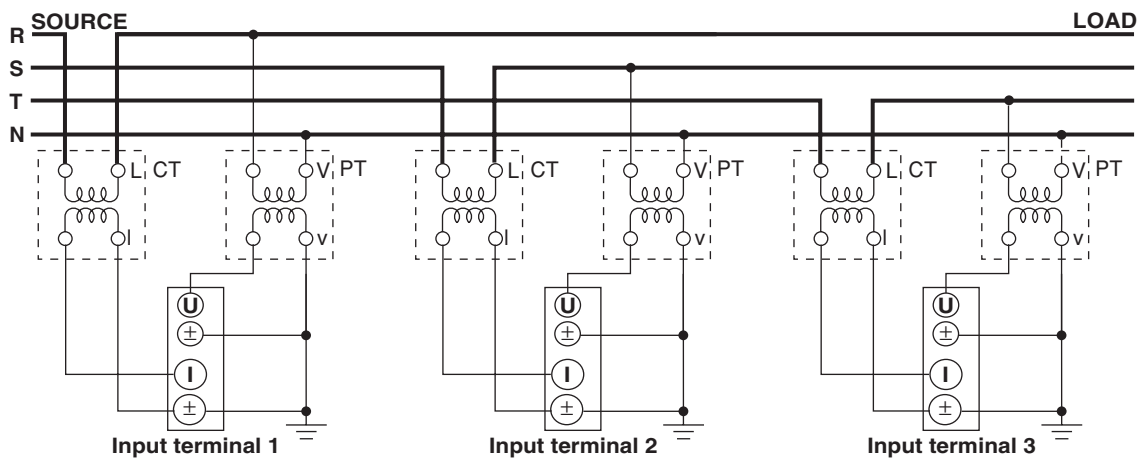

**Note**

For the relationship between the wiring systems and the method of determining the measured values or computed values, see Appendix 1, "Symbols and Determination of Measurement Functions."



## 3.9 Wiring a Circuit with Voltage Input Exceeding 600 V

When the voltage across the voltage input terminals exceeds 600 V, do not directly input the current to the current input terminals. Connect the output of an isolation sensor (CT, DT-CT, or clamp) to the current sensor input connector.



### WARNING

- The rated voltage between the input terminal (voltage input terminal, current input terminal, and current sensor input connector) and earth ground is 600 V. Do not apply a voltage exceeding 600 V.
- The rated voltage between the voltage and current input terminals, between the voltage input terminal and current sensor input connector, and between the current input terminal and current sensor input connector is 600 V. Do not apply a voltage exceeding 600 V.
- The rated voltage between the U-voltage input terminal and the terminal of voltage input terminal is 1000 V. Do not apply a voltage exceeding 1000 V.
- When the voltage across the voltage input terminals exceeds 600 V, do not directly input the current to the current input terminals. Connect the output of an isolation sensor (CT, DT-CT, or clamp) to the current sensor input connector.
- Follow the precautions given in section 3.3, "Wiring Precautions."

- **When the isolation sensor is current output**

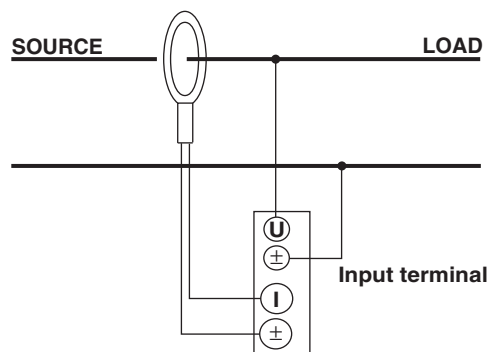

- **When the isolation sensor is voltage output**

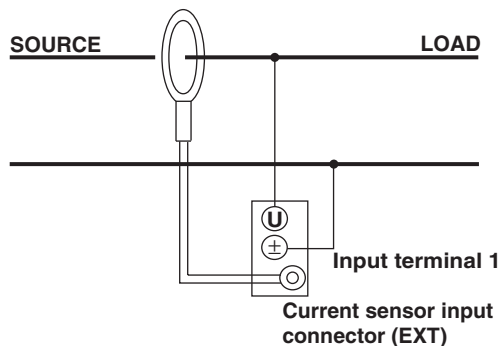

### Note

For wiring precautions, see also sections 3.7 and 3.8.

---

## 3.10 Turning ON/OFF the Power Switch

### Points to Check before Turning ON the Power

- Check that the instrument is installed properly (see section 3.2, “Installing the Instrument”).
- Check that the power cord is connected properly (see section 3.5, “Connecting the Power Supply”).
- Check that the circuit under measurement is wired properly (see sections 3.7 “Directly Wiring the Circuit under Measurement,” 3.8 “Using an External Current Sensor to Wire the Circuit under Measurement,” 3.9 “Using an External PT or CT to Wire the Circuit under Measurement,” and 3.10 “Wiring a Circuit with Voltage Input Exceeding 600 V.”)

### Location of the Power Switch

The power switch is located in the lower left corner of the front panel.

### Turning ON/OFF the Power Switch

The power switch is a push button. Press the button once to turn it “ON” and press it again to turn it “OFF.”

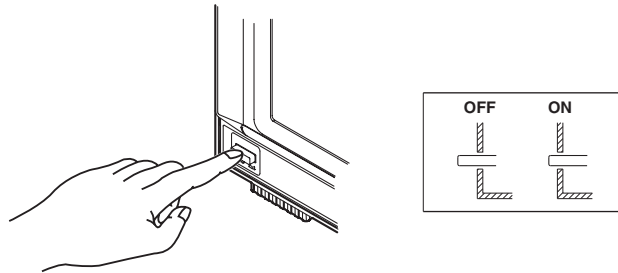

### The Order in Turning ON/OFF the Power

When using the model with the SCSI option and you wish to save or load data using an external SCSI device, turn ON the SCSI device first, then turn ON this instrument. When turning OFF the instrument and SCSI device, reverse the order.

### Power Up Operation

When the power switch is turned ON, the self-test starts automatically. When the self-test completes successfully, the display shows the screen that is displayed when the power switch is turned OFF.

---

#### **Note**

If the instrument does not operate as described above when the power switch is turned ON, turn OFF the power switch and check the following points.

- Check that the power cord is securely connected to the outlet.
- Check that the correct voltage is coming to the power outlet (see section 3.5, “Connecting the Power Supply”).
- Check that the fuse is not blown (see section 16.5, “Replacing the Power Fuse”).
- If the power switch is turned ON while pressing RESET, the setup parameters are initialized to their factory default values. For information on initialization, see section 15.3, “Initializing the Settings.”

If the instrument still does not work after checking these points, contact your nearest YOKOGAWA dealer for repairs.

---

**For Making Accurate Measurements**

- Allow the instrument to warm up for at least an hour after turning ON the power switch.
- Perform zero-level compensation after warm-up (see section 15.4, “Performing Zero-Level Compensation”).

**Shutdown Operation**

The setup parameters that exist immediately before the power switch is turned OFF are stored in memory. The same is true when the power cord gets disconnected from the outlet. The next time the power switch is turned ON, the instrument powers up using the stored setup parameters.

**Note**

---

A lithium battery is used to retain the setup parameters. When the lithium battery voltage falls below a certain level, a message is displayed on the screen (see section 16.2) when the power switch is turned ON. When this message appears frequently, the battery must be replaced quickly. The user cannot replace the battery. For battery replacement, contact your nearest YOKOGAWA dealer. For information regarding battery life, see section 16.6.

---

# 3.11 Setting the Date and Time

## Keys

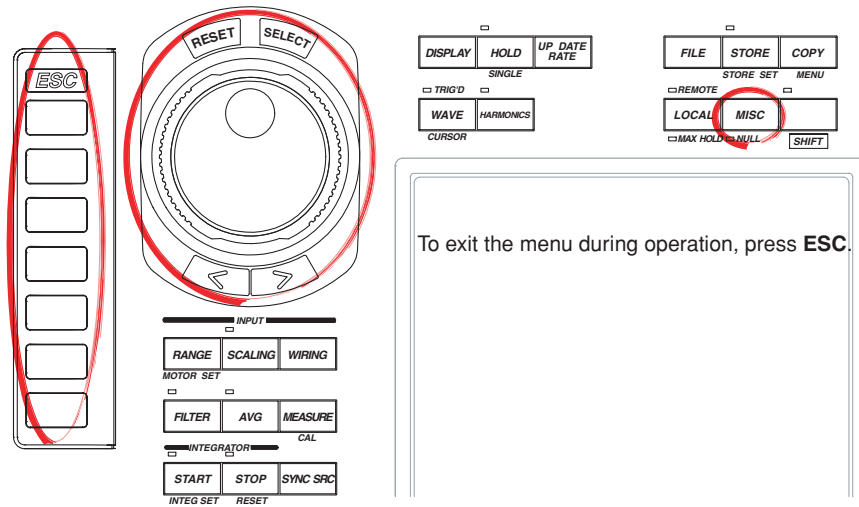

To exit the menu during operation, press **ESC**.

## Procedure

1. Press **MISC** to display the Misc menu.
  2. Press the **Date/Time** soft key to display the Date/Time dialog box.
- **Turning ON/OFF the Date/Time Display**
    3. Turn the **jog shuttle** to select Display.
    4. Press **SELECT** to select ON or OFF.
  - **Setting the Date and Time**
    5. Turn the **jog shuttle** to select Date or Time.
    6. Press **SELECT** to display the keyboard.
    7. Use the **keyboard** to set the date or time.  
For keyboard operations, see section 3.12, "Entering Values and Strings."
  - **Confirming the New Settings**
    8. Turn the **jog shuttle** to select Set.
    9. Press **SELECT**. If ON was selected in step 4, the new date and time are displayed in the lower right corner of the screen. If the procedure is aborted without pressing SELECT, the new settings are not reflected on the display.

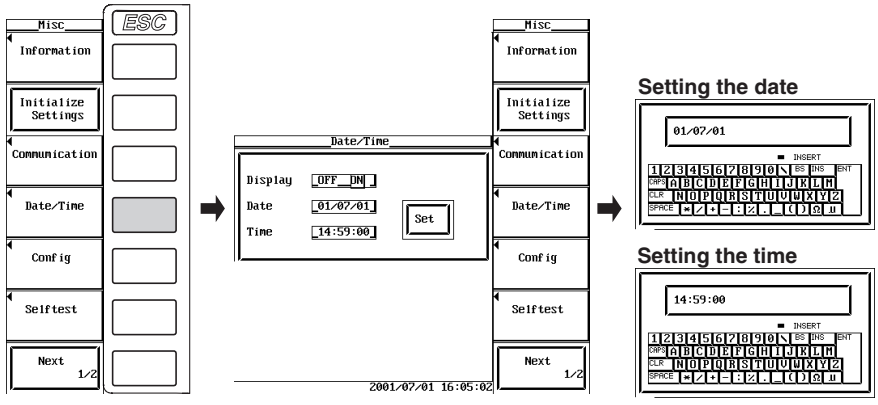

**Explanation**

- **Turning ON/OFF the Date/Time display**

You can select whether or not to display the date and time in the lower right corner of the screen.

- OFF: Do not display the date and time.
- ON: Display the date and time.

- **Setting the Date and Time**

- **Setting the date**

You can set the date in the form YY/MM/DD (year/month/day). Set the lower two digits of the year. Set 00 to 99 for years 2000 to 2099.

- **Setting the time**

You can set the time in the form HH:MM:SS (hour:minute:second). The hour is set using a 24-hour clock.

- **Confirming the New Settings**

When the date/time is turned ON/OFF, it is immediately reflected on the screen.

However, if you are changing the date and time, you must confirm the new settings. If you do not (abort the operation), the new settings will not take effect.

**Note**

- The date and time information is backed up with the lithium battery when the power is turned OFF.
- The instrument contains leap year information. The instrument determines the leap year calendar when the new settings are confirmed. If you enter [2/29] on a non-leap year, an error message will be displayed.

## 3.12 Entering Values and Strings

### Entering Values

After selecting the setup parameter with the SELECT key and soft keys, the value can be changed using the jog shuttle. The outer shuttle ring can be used step through the values in large increments. On some parameters, the arrow keys below the jog shuttle can be used to move among the digits.

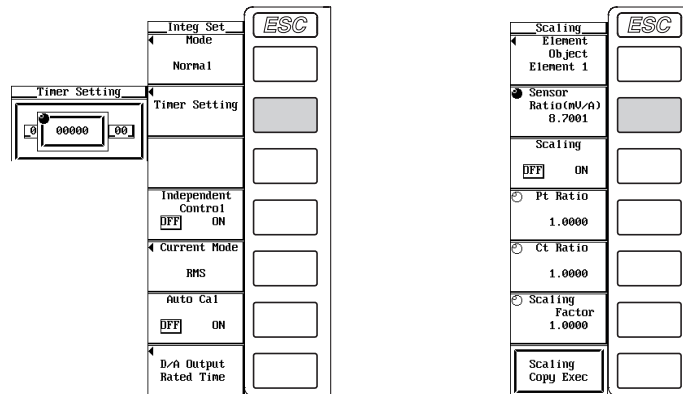

#### Note

Some of the parameters that can be changed using the jog shuttle are reset to their initial values when the RESET key is pressed.

### Entering Strings

The date/time, the equation for the user-defined function, a file name, and a comment can be entered using the keyboard that is displayed on the screen. The jog shuttle, arrow keys, and SELECT key are used to operate the keyboard to enter the character strings.

- **Entering the date or unit**

The following figure shows the keyboard that appears when setting the date or unit.

1. Turn the **jog shuttle** to select the character to be entered.
2. Press **SELECT** to enter the string in the entry box.  
If there are strings already in the entry box, use the arrow keys to select the entry position.
3. Repeat steps 1 and 2 to enter all the characters.
4. After entering all the characters, select **ENT** on the keyboard and press **SELECT**. The string is confirmed and the keyboard disappears.

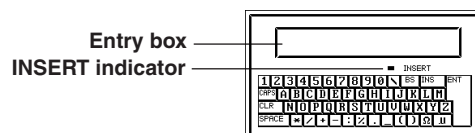

- **Entering the equation for the user-defined function**

The following figure shows the keyboard that appears when setting the equation for the user-defined function. Long equations can be temporarily held in the internal memory so that it can be used in other equations.

- **Entering the equation and temporarily storing it**

1. Turn the **jog shuttle** to select the character to be entered.  
(Long function names can be selected by pressing one key.)
2. Press **SELECT** to enter the string in the entry box.  
If there are strings already in the entry box, use the arrow keys to select the entry position.
3. Repeat steps 1 and 2 to enter all the characters.
4. After entering all the characters, select **ENT** on the keyboard and press **SELECT**. The string is confirmed and the keyboard disappears. At the same time, the equation is temporarily stored in the internal memory.
  - When the equation is not correct and an error message is displayed, it is still stored in the memory.
  - Up to five equations can be stored. Beyond five, for all successive equations, the oldest equation is cleared.

- **Recalling the temporarily stored equation**

1. Select  on the keyboard and press **SELECT**. A window opens and the temporarily stored equation is displayed.
2. Select the equation you wish to recall and press **SELECT**. The selected equation appears in the entry box on the keyboard.  
If there are strings already in the entry box, they are overwritten with the recalled equation.
3. Correct the recalled equation according to steps 1 to 4 in “Entering the equation and temporary storage” described above and confirm it. At this point, the equation is temporarily stored in the internal memory.

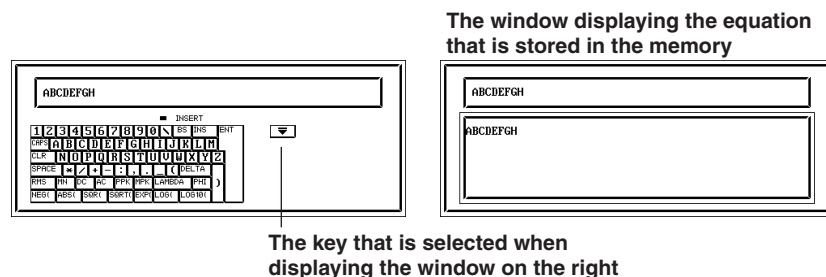

### 3.12 Entering Values and Strings

- **Enter the file name and comment (such as the server name, user name, password, and e-mail address for Ethernet communication)**

The following figure shows the keyboard that appears when setting the file name or comment. File names and comments can be temporarily held in the internal memory so that they can be used in other file names and comments.

- **Enter the file name and comment and temporarily storing them**

1. Turn the **jog shuttle** to select the character to be entered. You can also press the ▲ and ▼ soft keys to move the cursor vertically.
2. Press **SELECT** to enter the string in the entry box.  
If there are strings already in the entry box, use the arrow keys to select the entry position.
3. Repeat steps 1 and 2 to enter all the characters.
4. After entering all the characters, select **ENT** on the keyboard and press **SELECT**. The string is confirmed and the keyboard disappears (you can also press the **ENT** soft key to achieve the same result). At the same time, the confirmed string is temporarily stored in the internal memory.

Up to 8 sets of strings can be stored. Beyond eight, for all successive entries, the oldest string is cleared.

- **Recalling the temporary stored string**

1. Press the ↻ soft key. Each time the soft key is pressed the temporarily stored strings are displayed in the entry box of the keyboard in order. When the eight strings that are temporarily stored are displayed, the most recent string is displayed again.  
If there are strings already in the entry box, they are overwritten with the recalled string.
2. Correct the recalled equation according to steps 1 to 4 in “Entering the file name and comment and temporarily storing them” described above and confirm it. At this point, the string is temporarily stored in the internal memory.

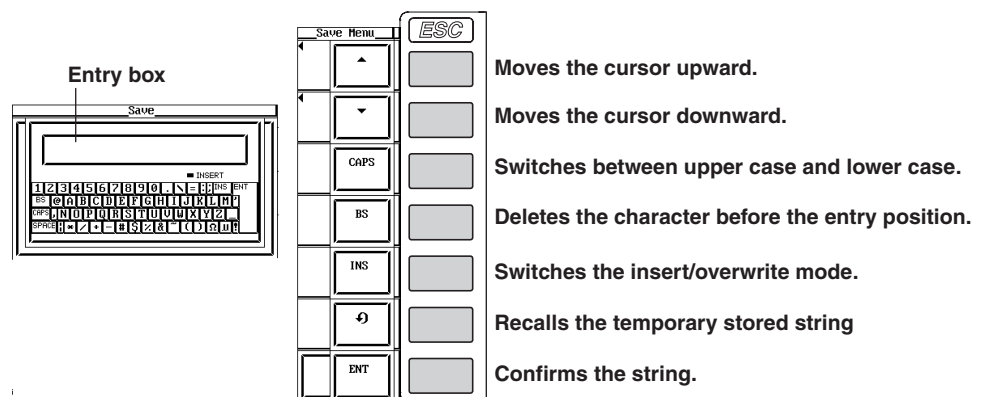



- **Keys other than the character keys**
  - BS: Deletes the character before the entry position.
  - INS: Switches the insert/overwrite mode. During the insert mode, the INSERT indicator on the keyboard lights. When a new character is entered in the insert mode, the new character is placed at the entry position and all following characters are moved backward. On the keyboard that appears when entering a file name or comment, pressing “RESET” on the front panel achieves the same operation as CLR.
  - CLR: Clears all displayed characters.
  - CAPS: Switches between upper case and lower case.
  - SPACE: Enters a space.
  - ENT: Confirms the displayed characters.

- **Number of characters and types that can be used**

Item	Number of Characters	Characters That Can Be Used
Date and time	Specified number	0 to 9 (/, :)
Equation	1 to 50 characters	Characters that are displayed on the keyboard and spaces
Unit	1 to 8 characters	Characters that are displayed on the keyboard and spaces
File Name	1 to 8 characters	0-9, A-Z, %, _, ( ) (parenthesis), – (minus sign)
Comment	0 to 25 characters	Characters that are displayed on the keyboard and spaces
Server name	0 to 40 characters	Characters that are displayed on the keyboard and spaces
User name	0 to 40 characters	Characters that are displayed on the keyboard and spaces
Password	0 to 40 characters	Characters that are displayed on the keyboard and spaces
E-mail address	0 to 40 characters	Characters that are displayed on the keyboard and spaces (the @ character cannot be entered consecutively.)

**Note**

- Upper and lower case letters are not distinguished for file names. They are distinguished in comments. In addition, the following five file names cannot be used due to limitations of MS-DOS.  
AUX, CON, PRN, NUL, and CLOCK
- When using the GP-IB or serial interface commands to enter a file name, the following symbols that do not exist on the keyboard of this instrument can be used.  
{ }

# 4.1 Displaying the Data (Numerical Data) of Measurement Functions

«For a functional description, see section 1.4.»

## Keys

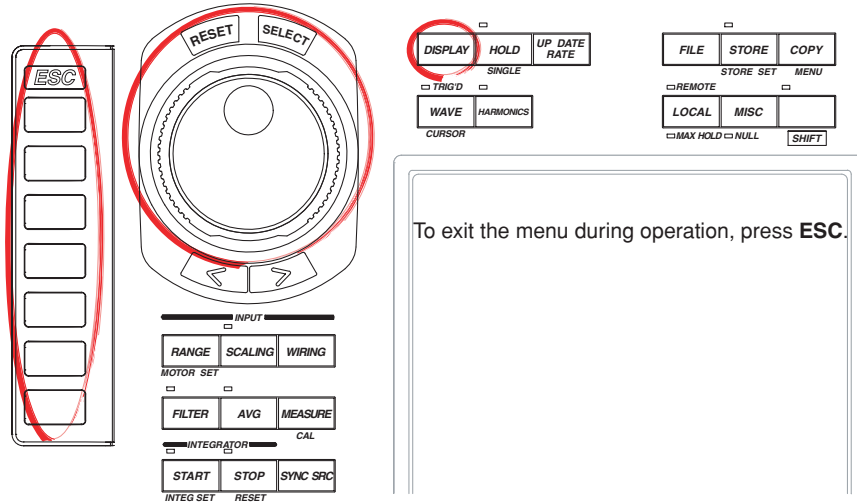

## Procedure

1. Press **DISPLAY** to display the Display menu.
2. Press the **Format** soft key to display the display format selection box.

### Displaying Numerical Data

3. Turn the **jog shuttle** to select Numeric, Numeric+Wave, Numeric+Bar (only during harmonic measurement), or Numeric+Trend.
4. Press **SELECT** to confirm the new display format.

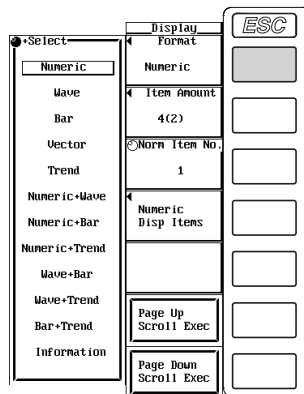

## 4.1 Displaying the Data (Numerical Data) of Measurement Functions

The following procedures are given for a representative example in which the display format is set to Numeric.

### During Normal Measurement

#### Selecting the Displayed Item

5. Press the **Item Amount** soft key to display the Item Amount menu.
6. Press one of the **4(2)** to **All** keys to select the number of displayed items.

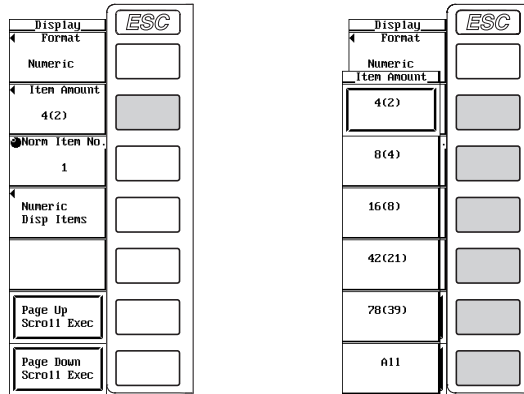

#### Scrolling the Display

7. Turn the **jog shuttle** to move the highlighting of the measurement function.
  - If the number of displayed items is set to 4(2) through 78(39), the item number of the highlighted measurement function is displayed in the Norm Item No. box of the Display menu.
  - If the number of displayed items is set to All, the symbol corresponding to the highlighted measurement function is displayed in the Function box of the Display menu.

#### When set to 4(2) to 78(39)

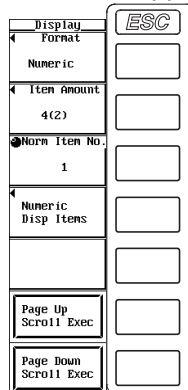

#### When set to All

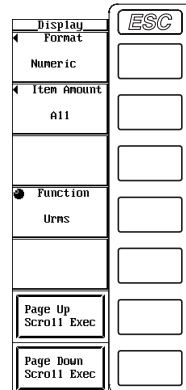

**Page Scrolling the Display**

7. Press the **Page Up Scroll Exec** or **Page Down Scroll Exec** soft key to scroll the page.
  - If you press the Page Up Scroll Exec soft key, the numerical data corresponding to item numbers that are smaller than those of the numerical data of measurement functions displayed up to that point are displayed.
  - If you press the Page Down Scroll Exec soft key, the numerical data corresponding to item numbers that are larger than those of the numerical data displayed up to that point are displayed.

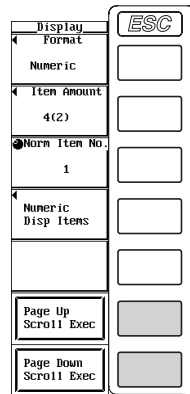

## 4.1 Displaying the Data (Numerical Data) of Measurement Functions

### During Harmonic Measurement

#### Selecting the Number of Displayed Items or List Display

5. Press the **Item Amount** soft key to display the Item Amount menu.
6. Select one of the **4(2)** to  $\Sigma$ List soft keys to select the number of displayed items or list display.

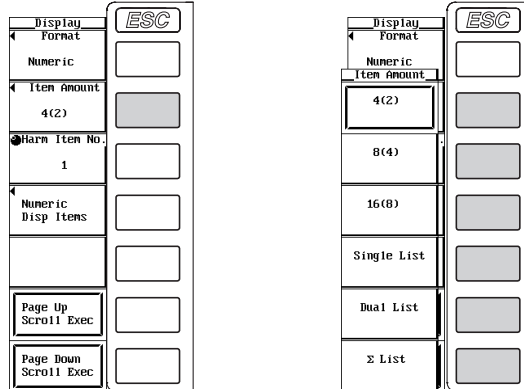

#### Scrolling the Display

7. Turn the **jog shuttle** to move the highlighting.
    - If the number of displayed items is set to 4(2) through 16(8), the item number of the highlighted measurement function is displayed in the Harm Item No. box of the Display menu.
    - If the number of displayed items is set to Single List or Dual List, the highlighted order is displayed in the Order box of the Display menu.
    - If the number of displayed items is set to  $\Sigma$ List, the symbol of the highlighted measurement function is displayed in the Function box in the Display menu and the order in the Order box.
- If the Function box is selected with the soft key, the measurement functions are scrolled. If the Order box is selected, the order is scrolled. The corresponding numerical data is displayed.

#### When set to 4(2) to 16(8)

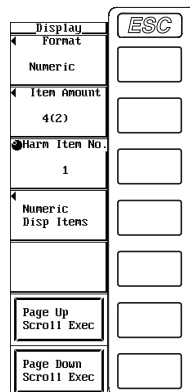

#### When set to Single List or Dual List

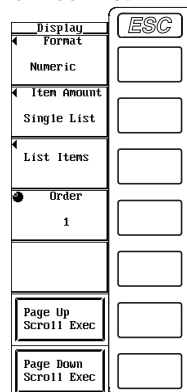

#### When set to $\Sigma$ List

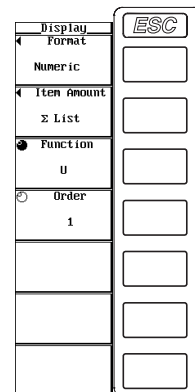

**Page Scrolling the Display**

- **When 4(2) through 16(8) is selected in step 6**

7. Press the **Page Up Scroll Exec** or **Page Down Scroll Exec** soft key to scroll the page.
  - If you press the Page Up Scroll Exec soft key, the numerical data corresponding to item numbers that are smaller than those of the data (numerical data) of measurement functions displayed up to that point are displayed.
  - If you press the Page Down Scroll Exec soft key, the numerical data corresponding to item numbers that are larger than those of the numerical data displayed up to that point are displayed.

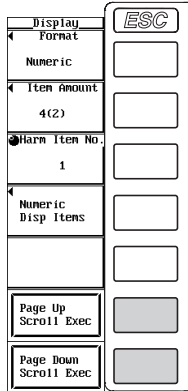

- **When Single List or Dual List is selected in step 6**

7. Press the **Page Up Scroll Exec** or **Page Down Scroll Exec** soft key to scroll the page.
  - If you press the Page Up Scroll Exec soft key, the numerical data corresponding to orders that are smaller than those of the numerical data displayed up to that point are displayed.
  - If you press the Page Down Scroll Exec soft key, the numerical data corresponding to orders that are larger than those of the numerical data displayed up to that point are displayed.

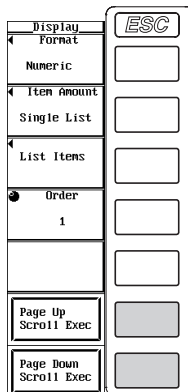

## 4.1 Displaying the Data (Numerical Data) of Measurement Functions

### Explanation

A display example is shown below. For the procedure in changing the displayed items and contents of numerical data, see chapters 6, 7, and 8.

The color changes from green to red when the input signal level exceeds approx. three or six times the specified measurement range when the crest factor is set to 3 or 6, respectively. The conditions of the input signals of elements 1 to 6 are displayed in order from the left.

Displayed only to products with the motor evaluation function (option). The color changes from green to red when the analog revolution/torque signal level exceeds approx. 180% of the specified measurement range. For pulse revolution signal, the color changes from green to red when approx.  $\pm 10$  V is exceeded. The first and second lines correspond to the conditions of rotating speed and torque, respectively.

The screenshot shows a display with the following data:

Measurement functions	Data
Urms1	93.33 V
Umn1	93.36 V
Udc1	-0.04 V
Uac1	93.33 V
Irms1	1.74 A
Imn1	0.00 A
Idc1	-0.01 A
Iac1	1.74 A

At the bottom left, the 'Update' line shows '570 Trend 0'. The right side of the screen shows a 'YOKOGAWA Display' menu with options: Format, Numeric, Item Amount (8(4)), Norm Item No. (1), Numeric Disp Items, Page Up Scroll Exec, and Page Down Scroll Exec.

#### Number of data updates

- The number of data updates is shown in the Update line at the lower left part of the screen.
- Press HOLD to stop the data from updating. The update number stops incrementing. Press HOLD again to allow updating to continue. The update number resumes incrementing.
- If the value exceeds 65535, it returns to 0.
- If the power is turned OFF, the number of data updates resets to 0.

### During Normal Measurement

#### Meaning of the Measurement Function Symbols

- For the meanings of the measurement function symbols that are displayed, see section 1.2, "Measurement Functions and Measurement Periods," 1.5, "Computation," 1.6, "Integration," appendix 1, "Symbols and Determination of Measurement Functions," and appendix 2, "Determination of Delta Computation."
- For details on the wiring units expressed as  $\Sigma A$ ,  $\Sigma B$ ,  $\Sigma C$ , see section 5.1, "Selecting the Wiring System."

#### Example The true rms value of the voltage of element 1

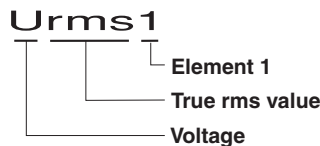

#### Simple average of the current of the elements combined by wiring unit $\Sigma A$

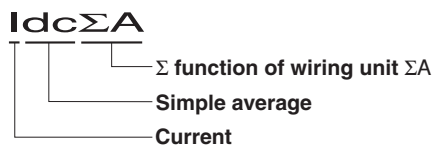

### Selecting the Display Format

Select the display format of the numerical data from the following list of choices. [-----] (no data) is displayed in places where the measurement function is not selected or where no numerical data is present.

- **Numeric**  
Only the numerical data is displayed.
  
- **Numeric+Wave**  
The numerical data and waveform are displayed separately in the top and bottom windows. For details on setting the waveform display, see section 4.2 and chapter 9.
- **Numeric+Trend**  
The numerical data and trend are displayed separately in the top and bottom windows. For details on setting the trend display, see section 4.5 and chapter 10.

### Selecting the Number of Displayed Items

Select the number of numerical data items that are displayed simultaneously from the following list of choices.

- **4(2)**
  - When the display format is Numeric, 4 numerical data values are displayed in one column.
  - When the display format is other than Numeric, 2 numerical data values are displayed.
- **8(4)**
  - When the display format is Numeric, 8 numerical data values are displayed in one column.
  - When the display format is other than Numeric, 4 numerical data values are displayed.
- **16(8)**
  - When the display format is Numeric, 16 numerical data values are displayed in two columns.
  - When the display format is other than Numeric, 8 numerical data values are displayed.
- **42(21)**
  - When the display format is Numeric, 42 numerical data values are displayed in three columns.
  - When the display format is other than Numeric, 21 numerical data values are displayed.
  
- **78(39)**
  - When the display format is Numeric, 78 numerical data values are displayed in three columns.
  - When the display format is other than Numeric, 39 numerical data values are displayed.
- **All**  
A table is displayed indicating the numerical data of items with measurement functions listed vertically and symbols indicating elements and wiring units listed horizontally. The number of displayed items varies depending on the number of installed elements.



### During Harmonic Measurement

#### Meaning of the Measurement Function Symbols

- For the meanings of the measurement function symbols that are displayed, see section 1.2, “Measurement Functions and Measurement Periods,” 1.5, “Computation,” and appendix 1, “Symbols and Determination of Measurement Functions.”
- For details on the wiring units expressed as  $\Sigma A$ ,  $\Sigma B$ ,  $\Sigma C$ , see section 5.1, “Selecting the Wiring System.”

#### Example 20<sup>th</sup> harmonic voltage of element 2

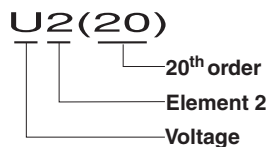

#### Average of the 30<sup>th</sup> harmonic current of the elements combined by wiring unit $\Sigma B$

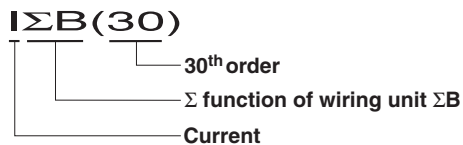

#### Selecting the Display Format

Select the display format of the numerical data from the following list of choices. [-----] (no data) is displayed in places where the measurement function is not selected or where no numerical data is present.

- Numeric  
Only the numerical data is displayed.
- Numeric+Wave  
The numerical data and waveform are displayed separately in the top and bottom windows. For details on setting the waveform display, see section 4.2 and chapter 9.
- Numeric+Bar  
The numerical data and bar graph are displayed separately in the top and bottom windows. For details on setting the bar graph display, see section 4.3 and section 7.9.
- Numeric+Trend  
The numerical data and trend are displayed separately in the top and bottom windows. For details on setting the trend display, see section 4.5 and chapter 10.

#### Selecting the Number of Displayed Items or List Display

Select the number of numerical data items that are displayed simultaneously or list display from the following list of choices.

- 4(2)
  - When the display format is Numeric, 4 numerical data values are displayed in one column.
  - When the display format is other than Numeric, 2 numerical data values are displayed.
- 8(4)
  - When the display format is Numeric, 8 numerical data values are displayed in one column.
  - When the display format is other than Numeric, 4 numerical data values are displayed.
- 16(8)
  - When the display format is Numeric, 16 numerical data values are displayed in two columns.
  - When the display format is other than Numeric, 8 numerical data values are displayed.

- Single List
  - When the display format is Numeric, 48 numerical data values for a single measurement function are displayed in two columns.
  - When the display format is other than Numeric, 22 numerical data values for a single measurement function are displayed in two columns.
- Dual List
  - When the display format is Numeric, 24 numerical data values each for two measurement functions are displayed in each column.
  - When the display format is other than Numeric, 11 numerical data values each for two measurement functions are displayed in each column.
- $\Sigma$  List
  - When the display format is Numeric, a table is displayed indicating the numerical data of items with 19 measurement functions (such as U, I, P, S, Q,  $\lambda$ ,  $\phi$ ) listed vertically and symbols indicating elements and wiring units listed horizontally.
  - When the display format is other than Numeric, a table is displayed indicating the numerical data of items with 11 measurement functions (such as U, I, P, S, Q,  $\lambda$ ,  $\phi$ ) listed vertically and symbols indicating elements and wiring units listed horizontally.
  - A table is displayed for each order.

### Note

- All harmonic orders (Total) or from dc (0<sup>th</sup> order) up to 100<sup>th</sup> order can be displayed. However, the numerical data up to the order corresponding to the upper limit of harmonic order under analysis (see section 17.6) that is automatically determined by the frequency of the PLL source is the data determined by the harmonic measurement.
- [-----] (no data) is displayed in places where the measurement function is not selected or where no numerical data is present.
- If Urms, Umn, Uac, Udc, Irms, Imn, lac, or Idc exceeds 140% of the measurement range, over the range [-OL-] is displayed.
- P shows over the range [-OL-] if the measured values of either the voltage or current exceeds 140% of the measurement range.
- If the measured or computed result cannot be displayed using the specified decimal position or unit, overflow [-OF-] is displayed.
- If Urms, Uac, Irms, or lac is less than or equal to 0.3% (when the crest factor is set to 3; less than or equal to 0.6% when the crest factor is set to 6) or Umn or Imn is less than or equal to 1% (when the crest factor is set to 3; less than or equal to 2% when the crest factor is set to 6) of the measurement range, Urms, Umn, Uac, Irms, Imn, lac, and the measurement functions that are determined using these measurement functions display zeroes.  $\lambda$  or  $\phi$  displays an error.
- If the measured value of frequency is outside the measurement range, fU or fI displays an error.
- If both the voltage and current are sinusoids and the ratio of the voltage and current inputs do not differ greatly with respect to the measurement range, the phase difference  $\phi$  of lead (D) and lag (G) are detected correctly.
- If the power factor  $\lambda$  is greater than 1 and less than or equal to 2,  $\lambda$  becomes [1].  $\phi$  displays zero.
- If the power factor  $\lambda$  is greater than 2,  $\lambda$  and  $\phi$  display errors.

## 4.2 Displaying Waveforms

«For a functional description, see section 1.7.»

### Keys

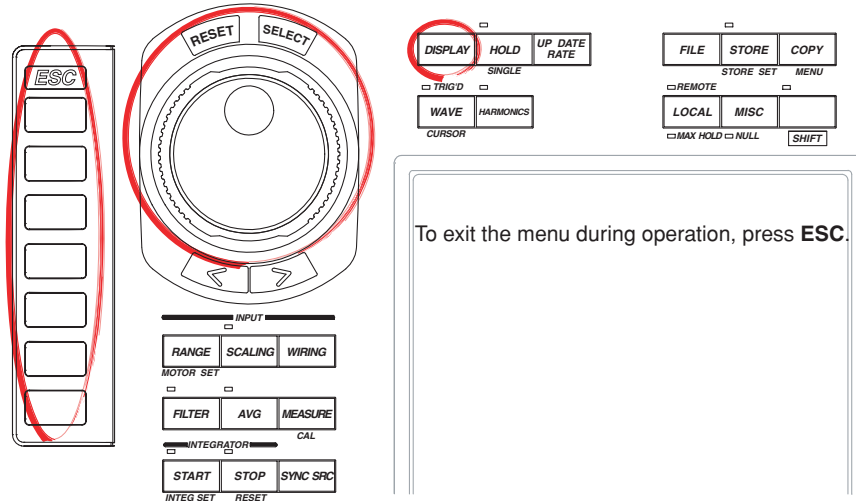

### Procedure

The retrieval of waveform display data must be turned ON to display waveforms. For the procedure, see section 9.1.

1. Press **DISPLAY** to display the Display menu.
2. Press the **Format** soft key to display the display format selection box.

### Displaying Waveforms

3. Turn the **jog shuttle** to select Wave, Numeric+Wave, Wave+Bar (only during harmonic measurement), or Wave+Trend.
4. Press **SELECT** to confirm the new display format.

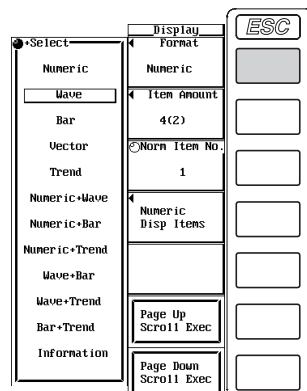

**Explanation**

A display example is shown below. For the procedure in changing the displayed items and contents of waveforms, see chapter 9.

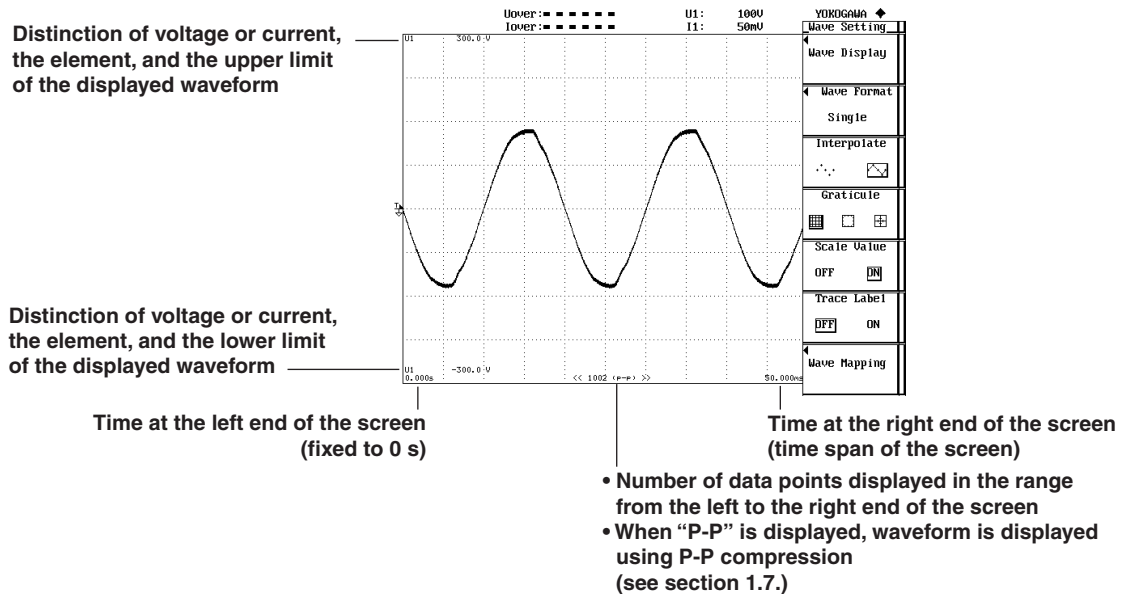
**Selecting the Display Format**

Select the waveform display format from the following list of choices.

- Wave  
Only waveforms are displayed.
- Numeric+Wave  
The numerical data and waveform are displayed separately in the top and bottom windows. For details on setting the numerical data display, see section 4.1, chapters 6, 7, and 8.
- Wave+Bar  
The waveform and bar graph are displayed separately in the top and bottom windows. The bar graph is valid during harmonic measurement. For details on setting the bar graph display, see section 4.3 and section 7.9.
- Wave+Trend  
The waveform and trend are displayed separately in the top and bottom windows. For details on setting the trend display, see section 4.5 and chapter 10.

## 4.3 Displaying Bar Graphs

«For a functional description, see section 1.8.»

### Keys

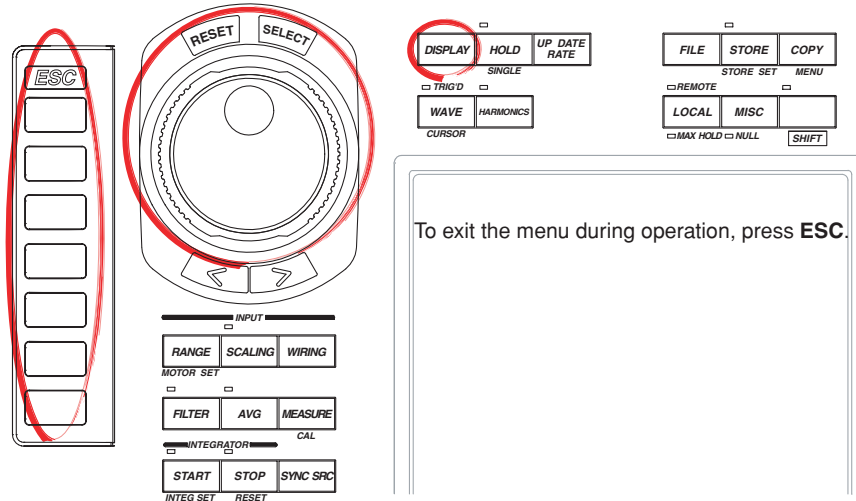

### Procedure

Check that the measurement mode is set to harmonic measurement. If the measurement mode is set to normal measurement, set Mode to ON in the Harmonics menu (see section 7.1).

1. Press **DISPLAY** to display the Display menu.
2. Press the **Format** soft key to display the display format selection box.

### Displaying Bar Graphs

3. Turn the **jog shuttle** to select Wave, Bar, Numeric+Bar, Wave+Bar, or Bar+Trend.
4. Press **SELECT** to confirm the new display format.

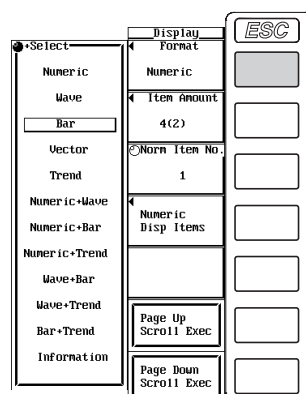

## Explanation

A display example is shown below. For the procedure in changing the displayed items and contents of bar graphs, see section 7.9. When the vertical axis is set to logarithmic coordinates, the characters <log Scale> appears at the upper left corner of the screen.

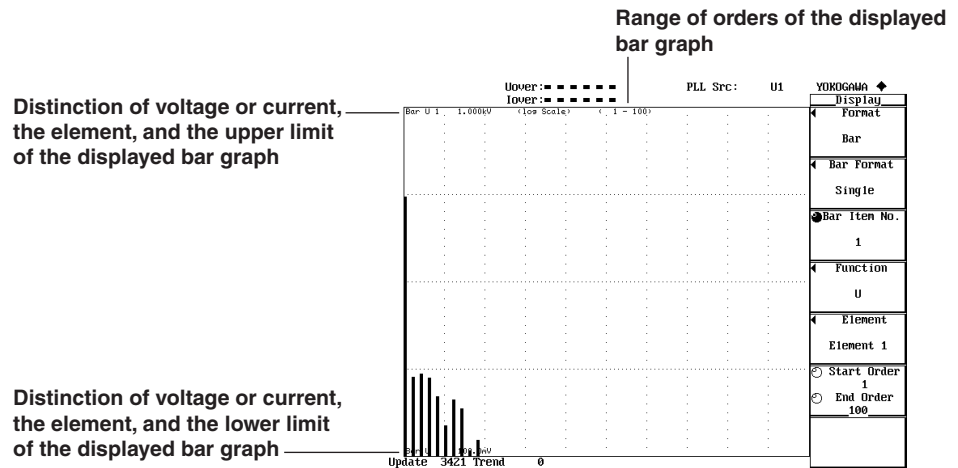

#### Selecting the Display Format

Select the bar graph display format from the following list of choices.

- Bar  
Only bar graphs are displayed.
- Numeric+Bar  
The numerical data and bar graph are displayed separately in the top and bottom windows. For details on setting the numerical data display, see section 4.1, chapters 6, 7, and 8.
- Wave+Bar  
The waveform and bar graph are displayed separately in the top and bottom windows. For details on setting the waveform display, see section 4.2 and chapter 9.
- Bar+Trend  
The bar graph and trend are displayed separately in the top and bottom windows. For details on setting the trend display, see section 4.5 and chapter 10.

## 4.4 Displaying Vectors

«For a functional description, see section 1.8.»

### Keys

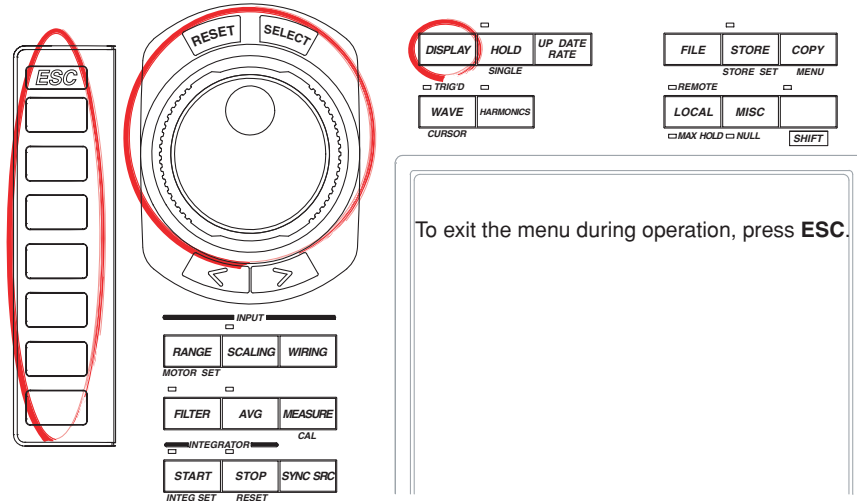

### Procedure

Check that the measurement mode is set to harmonic measurement. If the measurement mode is set to normal measurement, set Mode to ON in the Harmonics menu (see section 7.1).

1. Press **DISPLAY** to display the Display menu.
2. Press the **Format** soft key to display the display format selection box.

### Displaying Vectors

3. Turn the **jog shuttle** to select Vector.
4. Press **SELECT** to confirm the new display format.

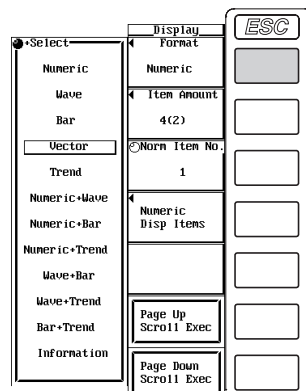

### Explanation

The phase and size (rms value) relationship between the fundamental waves  $U(1)$  and  $I(1)$  of each element specified for harmonic measurement (see section 7.3) can be displayed using vectors. The positive vertical axis is set to 0 (angle 0), and the vector of each input signal is displayed.

For examples of vector displays and the procedure in changing the displayed items and contents, see section 7.10.

## 4.5 Displaying Trends

### Keys

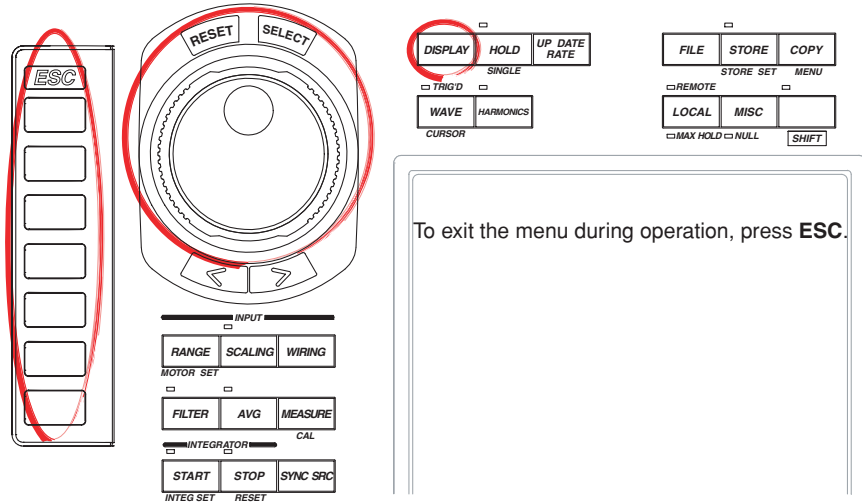

### Procedure

The retrieval of trend display data must be turned ON to display trends. For the procedure, see section 10.1.

1. Press **DISPLAY** to display the Display menu.
2. Press the **Format** soft key to display the display format selection box.

### Displaying Trends

3. Turn the **jog shuttle** to select Trend, Numeric+Trend, Wave+Trend, or Bar+Trend.
4. Press **SELECT** to confirm the new display format.

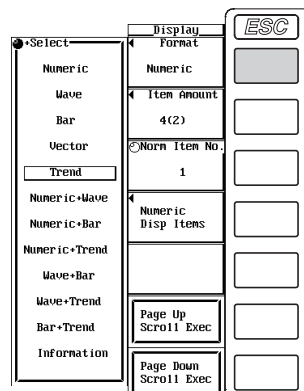



## 4.5 Displaying Trends

### Explanation

A display example is shown below. For the procedure in changing the displayed items and contents of trends, see chapter 10. When the retrieval of waveform display data is OFF (see section 9.1) during normal measurement, the horizontal axis is expressed using time as shown below. During harmonic measurement or when the retrieval of waveform display data is ON, the horizontal axis is expressed using the number of data points on the screen.

The trend value in the held condition (see section 5.8) is the same as the numerical data when HOLD is pressed. When hold is released, the trend that was held is displayed.

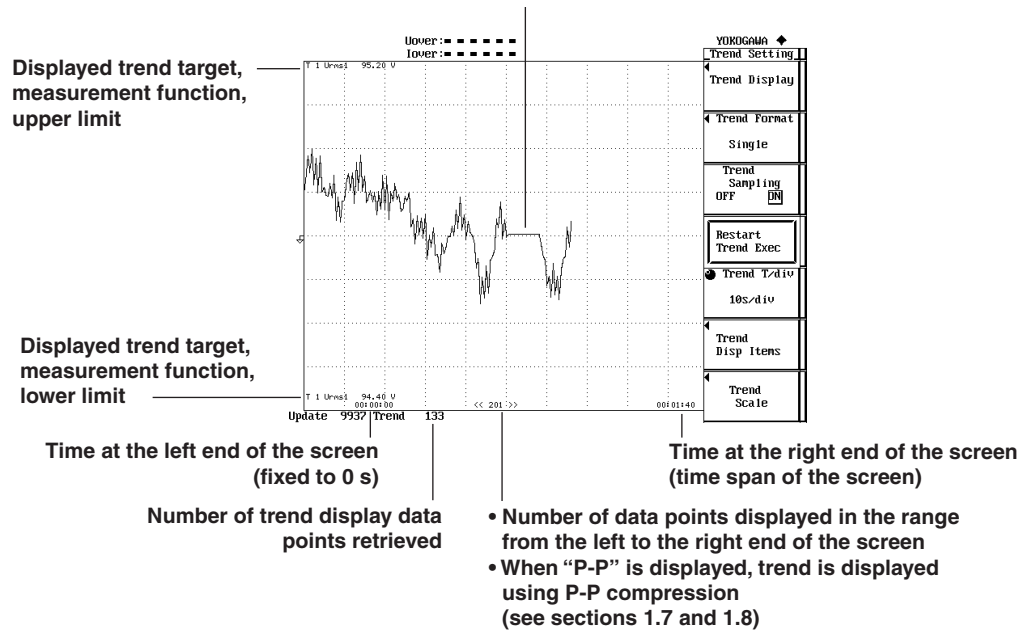

### Selecting the Display Format

Select the trend display format from the following list of choices.

- Trend  
Only trends are displayed.
- Numeric+Trend  
The numerical data and trend are displayed separately in the top and bottom windows. For details on setting the numerical data display, see section 4.1, chapters 6, 7, and 8.
- Wave+Trend  
The waveform and trend are displayed separately in the top and bottom windows. For details on setting the waveform display, see section 4.2 and chapter 9.
- Bar+Trend  
The bar graph and trend are displayed separately in the top and bottom windows. For details on setting the bar graph display, see section 4.3 and section 7.9.

## 4.6 Listing the Setup Parameters

### Keys

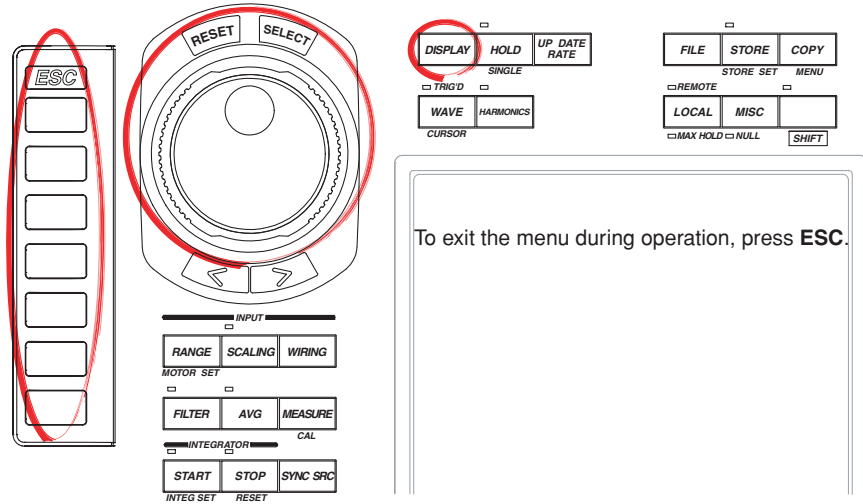

### Procedure

1. Press **DISPLAY** to display the Display menu.
2. Press the **Format** soft key to display the display format selection box.

### Selecting the List of Setup Parameters

3. Turn the **jog shuttle** to select Information.
4. Press **SELECT** to confirm the new display format.

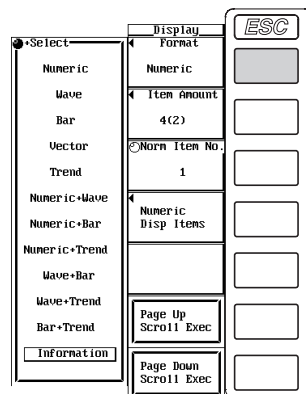

## 4.6 Listing the Setup Parameters

### Displaying the Relation Table of Elements and Measurement Ranges

- Press the **Power Element** soft key. The relation table of measurement ranges, input filters, transformation ratios, scaling factors, and other parameters are displayed for each element.

### Displaying the Relation Table of Trend Targets and Measurement Functions

- Press the **Trend** soft key to display the relation table of trend targets and measurement functions.

### Displaying the Relation Table of D/A Output Channels and Measurement Functions\*

- Press the **D/A Output** soft key to display the relation table of D/A output channels and measurement functions.

\* Displayed only on products with the D/A output (option).

### Displaying the Relation Table of Rotating Speeds and the Input Ranges of Torque\*

- Press the **Motor Element** soft key. A relation table of the rotating speed and the input range, filter, scaling factor, unit, and synchronization source of torque, number of poles, frequency measurement source, and other parameters is displayed.

\* Displayed only to products with the motor evaluation function (option).

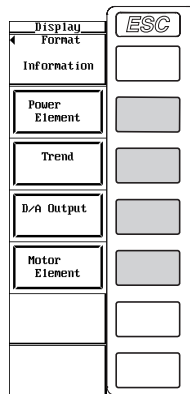

## Explanation

### Relation Table of Elements and Measurement Ranges

If the menu is cleared using ESC, a relation table of up to 6 elements is displayed. The following figure shows an example when the crest factor is set to 3.

Upper: - - - - -  
Lower: - - - - -  
Power Element Settings

	Element1	Element2	Element3	Element4	Element5	Element6
U Range	10U	100U	1000U	1000U	1000U	1000U
I Range	10U	50A	50A	50A	50A	50A
Terminal	Sensor	Direct	Direct	Direct	Direct	Direct
Line Filter	Off	Off	Off	Off	Off	Off
2-Cross Filter	Off	Off	Off	Off	Off	Off
Sensor Ratio (mV/A)	10.0000	10.0000	10.0000	10.0000	10.0000	10.0000
Scaling	Off	Off	Off	Off	Off	Off
Pt Ratio	1.0000	1.0000	1.0000	1.0000	1.0000	1.0000
Ct Ratio	1.0000	1.0000	1.0000	1.0000	1.0000	1.0000
Scaling Factor	1.0000	1.0000	1.0000	1.0000	1.0000	1.0000
Sync. Src	11	12	13	14	15	16

**Relation Table of Trend Targets and Measurement Functions**

Upper: ■■■■■  
Lower: ■■■■■  
**Trend Settings**

	Normal Function	Harmonics Function		Normal Function	Harmonics Function
☐T 1	Urms1	U1(1)	☐T 9	Urms2	U2(1)
☐T 2	Irms1	I1(1)	☐T10	Irms2	I2(1)
☐T 3	P1	P1(1)	☐T11	P2	P2(1)
☐T 4	S1	S1(1)	☐T12	S2	S2(1)
☐T 5	Q1	Q1(1)	☐T13	Q2	Q2(1)
☐T 6	$\lambda$ 1	$\lambda$ 1(1)	☐T14	$\lambda$ 2	$\lambda$ 2(1)
☐T 7	$\phi$ 1	$\phi$ 1(1)	☐T15	$\phi$ 2	$\phi$ 2(1)
☐T 8	FU1	FU1(1)	☐T16	FU2	$\phi$ 2(1)

**Relation Table of D/A Output Channels and Measurement Functions**

Displayed only on products with the D/A output (option).

Upper: ■■■■■  
Lower: ■■■■■  
**D/A Output Settings**

	Normal Function	Harmonics Function		Normal Function	Harmonics Function
Ch 1	Urms1	U1	Ch16	U+pk1	S1(3)
Ch 2	Umn1	I1	Ch17	U-pk1	Q1(3)
Ch 3	Udc1	P1	Ch18	I+pk1	$\lambda$ 1(3)
Ch 4	Uac1	S1	Ch19	I-pk1	U1(5)
Ch 5	Irms1	Q1	Ch20	CFU1	I1(5)
Ch 6	Imn1	$\lambda$ 1	Ch21	CF11	P1(5)
Ch 7	Iac1	U1(1)	Ch22	Time1	S1(5)
Ch 8	Iac1	I1(1)	Ch23	Up1	Q1(5)
Ch 9	P1	P1(1)	Ch24	Up+1	$\lambda$ 1(5)
Ch10	S1	S1(1)	Ch25	Up-1	U1(7)
Ch11	Q1	Q1(1)	Ch26	q1	I1(7)
Ch12	$\lambda$ 1	$\lambda$ 1(1)	Ch27	q+1	P1(7)
Ch13	$\phi$ 1	U1(3)	Ch28	q-1	S1(7)
Ch14	FU1	I1(3)	Ch29	$\eta$	Q1(7)
Ch15	F11	P1(3)	Ch30	L/η	$\lambda$ 1(7)

**Relation Table of the Rotating Speed of Motor Evaluation Function (Option) and**

**Input Ranges of Torque**

Displayed only to products with the motor evaluation function (option).

Upper: ■ ■ ■ Spd: ■  
Lower: ■ ■ ■ Trq: ■

**Motor Element Settings**

	Speed	Torque	Pn
Range	200	200	
Sense Type	Analog		----
Pulse Range	0.0000-10000.0000	----	----
Line Filter	Off	Off	----
Scaling	1.0000	1.0000	1.0000
Unit	rpm	Nm	W
Pulse N	60		
Pole	2		
Sync Speed	<input checked="" type="checkbox"/> 11		
Sync Source	None		

# 5.1 Selecting the Wiring System

**Keys**

«For a functional description, see section 1.3.»

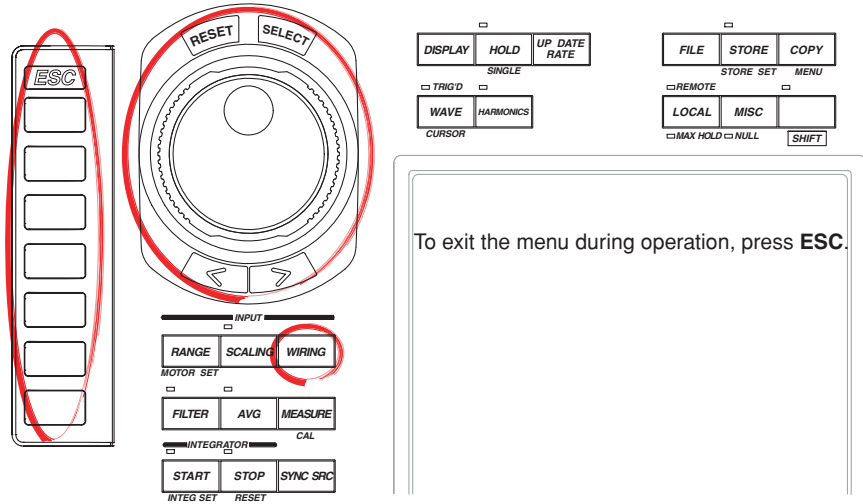

**Procedure**

1. Press **WIRING** to open the Wiring dialog box.

**Selecting the Wiring System Pattern**

2. Turn the **jog shuttle** to select Pattern.  
If the wiring system pattern on all elements is set to 1P2W (single-phase, two-wire) as shown below, the cursor remains at Pattern even if you turn the jog shuttle.

Example in which six elements are installed

Wiring						
Element	[ 1 ]	[ 2 ]	[ 3 ]	[ 4 ]	[ 5 ]	[ 6 ]
Pattern	[ 1P2W ]	[ 1P2W ]	[ 1P2W ]	[ 1P2W ]	[ 1P2W ]	[ 1P2W ]
Σ A	1P2W					
Σ B	1P2W					
Σ C	1P2W					

3. Press **SELECT** to open the pattern selection window.
4. Turn the **jog shuttle** to select a pattern.
5. Press **SELECT** to confirm the new pattern.

Example in which six elements are installed

Wiring						
Element	[ 1 ]	[ 2 ]	[ 3 ]	[ 4 ]	[ 5 ]	[ 6 ]
Pattern	[ 1P2W ]	[ 1P2W ]	[ 1P2W ]	[ 1P2W ]	[ 1P2W ]	[ 1P2W ]
Σ A	[ 1P2W ]	[ 1P2W ]	[ 1P2W ]	[ 1P2W ]	[ 1P2W ]	[ 1P2W ]
Σ B	[ 1P3W/3P3W ]	[ 1P3W/3P3W ]	[ 1P3W/3P3W ]	[ 1P3W/3P3W ]	[ 1P3W/3P3W ]	[ 1P3W/3P3W ]
Σ C	[ 1P3W/3P3W ]	[ 3P4W/3U3A ]	[ 3P4W/3U3A ]	[ 1P2W ]	[ 1P2W ]	[ 1P2W ]
	[ 3P4W/3U3A ]	[ 1P3W/3P3W ]	[ 1P2W ]	[ 1P2W ]	[ 1P2W ]	[ 1P2W ]
	[ 3P4W/3U3A ]	[ 3P4W/3U3A ]	[ 3P4W/3U3A ]	[ 3P4W/3U3A ]	[ 3P4W/3U3A ]	[ 3P4W/3U3A ]

## 5.1 Selecting the Wiring System

### Selecting the Wiring System

- The procedure described here is not necessary, if the wiring system of all elements was set to 1P2W (single-phase, two-wire) in the previous section “Selecting the Wiring System Pattern.”
  - Two types of wiring systems that use two elements are available: 1P3W (single-phase, three-wire) and 3P3W (three-phase, three-wire). You can select either type through the procedure described here.
  - Two types of wiring systems that use three elements are available: 3P4W (three-phase, four-wire) and 3V3A (three-voltage, three-current). You can select either type through the procedure described here.
6. Turn the **jog shuttle** to select wiring unit  $\Sigma A$ ,  $\Sigma B$ , or  $\Sigma C$ .  
Some of the wiring units may not be selectable depending on the number of installed elements.
  7. Press **SELECT** to select the wiring system.
  8. Repeat steps 6 and 7 to select the wiring system for all wiring units  $\Sigma A$ ,  $\Sigma B$ , and  $\Sigma C$ .

#### Example in which six elements are installed

Wiring						
Element	[ 1 ]	[ 2 ]	[ 3 ]	[ 4 ]	[ 5 ]	[ 6 ]
	$\Sigma A$		$\Sigma B$		$\Sigma C$	
Pattern	[ 1P3W/3P3W ]	[ 1P3W/3P3W ]	[ 1P3W/3P3W ]	[ 1P3W/3P3W ]	[ 1P3W/3P3W ]	[ 1P3W/3P3W ]
$\Sigma A$	[ 1P3W ] [ 3P3W ]					
$\Sigma B$	[ 1P3W ] [ 3P3W ]					
$\Sigma C$	[ 1P3W ] [ 3P3W ]					

**Explanation**

- The selectable wiring systems vary depending on the number of input elements that are installed in the instrument. You may be able to select only a single type of wiring system or two or three types of wiring systems. You can select the wiring system from the following five types.  
1P2W (single-phase, two-wire), 1P3W (single-phase, three-wire), 3P3W (three-phase, three-wire), 3P4W (three-phase, four-wire), and 3V3A (three-voltage, three-current)
- The input element assignment to wiring units  $\Sigma A$ ,  $\Sigma B$ , and  $\Sigma C$  is determined from the wiring system pattern. This allows  $\Sigma$  functions of voltage, current, active power, apparent power, reactive power, power factor, phase difference, and other parameters to be determined. For the relationship concerning the wiring system and the determination of the  $\Sigma$  function, see appendix 1.
- The following table shows the relationship between the number of installed elements, the selectable wiring system patterns, and the assignment of input elements to wiring units  $\Sigma A$ ,  $\Sigma B$ , and  $\Sigma C$ .

Installed input elements	1					
Wiring system Pattern 1	1P2W					
Installed input elements	1	2				
Wiring system Pattern 1	1P2W	1P2W				
Wiring system Pattern 2	1P3W or 3P3W( $\Sigma A$ )					
Installed input elements	1	2	3			
Wiring system Pattern 1	1P2W	1P2W	1P2W			
Wiring system Pattern 2	1P3W or 3P3W( $\Sigma A$ )		1P2W( $\Sigma B$ )			
Wiring system Pattern 3	1P2W( $\Sigma A$ )	1P3W or 3P3W( $\Sigma B$ )				
Wiring system Pattern 4	3P4W or 3V3A( $\Sigma A$ )					
Installed input elements	1	2	3	4		
Wiring system Pattern 1	1P2W	1P2W	1P2W	1P2W		
Wiring system Pattern 2	1P3W or 3P3W( $\Sigma A$ )		1P3W or 3P3W( $\Sigma B$ )			
Wiring system Pattern 3	3P4W or 3V3A( $\Sigma A$ )			1P2W( $\Sigma B$ )		
Wiring system Pattern 4	1P2W( $\Sigma A$ )	3P4W or 3V3A( $\Sigma B$ )				
Installed input elements	1	2	3	4	5	
Wiring system Pattern 1	1P2W	1P2W	1P2W	1P2W	1P2W	
Wiring system Pattern 2	1P3W or 3P3W( $\Sigma A$ )		1P3W or 3P3W( $\Sigma B$ )		1P2W( $\Sigma C$ )	
Wiring system Pattern 3	1P3W or 3P3W( $\Sigma A$ )		3P4W or 3V3A( $\Sigma B$ )			
Wiring system Pattern 4	3P4W or 3V3A( $\Sigma A$ )			1P3W or 3P3W( $\Sigma B$ )		
Installed input elements	1	2	3	4	5	6
Wiring system Pattern 1	1P2W	1P2W	1P2W	1P2W	1P2W	1P2W
Wiring system Pattern 2	1P3W or 3P3W( $\Sigma A$ )		1P3W or 3P3W( $\Sigma B$ )		1P3W or 3P3W( $\Sigma C$ )	
Wiring system Pattern 3	1P3W or 3P3W( $\Sigma A$ )		3P4W or 3V3A( $\Sigma B$ )			1P2W( $\Sigma C$ )
Wiring system Pattern 4	3P4W or 3V3A( $\Sigma A$ )			1P3W or 3P3W( $\Sigma B$ )		1P2W( $\Sigma C$ )
Wiring system Pattern 5	3P4W or 3V3A( $\Sigma A$ )			3P4W or 3V3A( $\Sigma B$ )		

**Note**

- Select the wiring system to match the circuit under measurement that is actually wired. The method in which the  $\Sigma$  function is determined varies depending on the wiring system. If the selected wiring system does not match the actual circuit, measurements and computation will not be correct.
- For the relationship concerning the wiring system and the determination of the  $\Sigma$  function, see appendix 1.

## 5.2 Setting the Measurement Range during Direct Input

«For a functional description, see section 1.3.»

### Keys

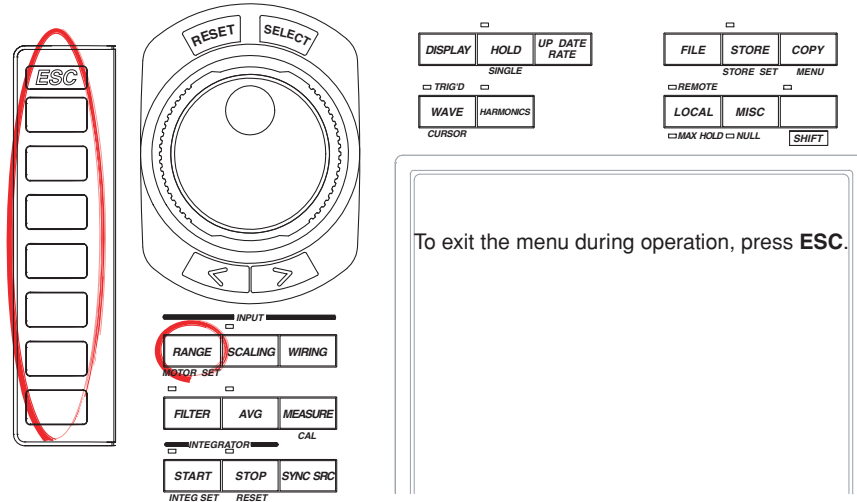

### Procedure

1. Press **RANGE** to display the Range menu.

#### Selecting the Target Element

2. Press the **Element Object** soft key to display the Element menu.  
Only the installed elements are displayed.
3. Press one of the soft keys corresponding to the displayed element to select the target element. The selected element is displayed at the upper right corner of the screen (if you selected element 1, U1 and I1 are displayed).

#### Setting the Voltage Range

4. Press the **U Range Up Exec** or **U Range Down Exec** soft key to set the voltage range. The specified range is displayed by the element displayed at the upper right corner of the screen.
  - Pressing the U Range Up Exec soft key increases the voltage range.  
If you press the U Range Up Exec soft key when the range is at maximum, auto range is enabled.
  - Pressing the U Range Down Exec soft key decreases the voltage range.

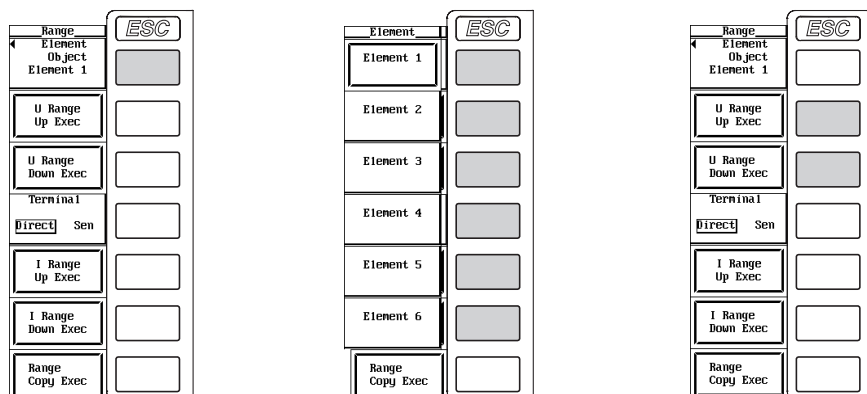



**Setting the Current Range**

- **Selecting the current input terminal**

5. Press the **Terminal** soft key to select Direct.

- **Setting the current range**

6. Press the **I Range Up Exec** or **I Range Down Exec** soft key to set the current range. The specified range is displayed by the element displayed at the upper right corner of the screen.

- Pressing the **I Range Up Exec** soft key increases the current range.  
If you press the **I Range Up Exec** soft key when the range is at maximum, auto range mode is enabled.
- Pressing the **I Range Down Exec** soft key decreases the current range.

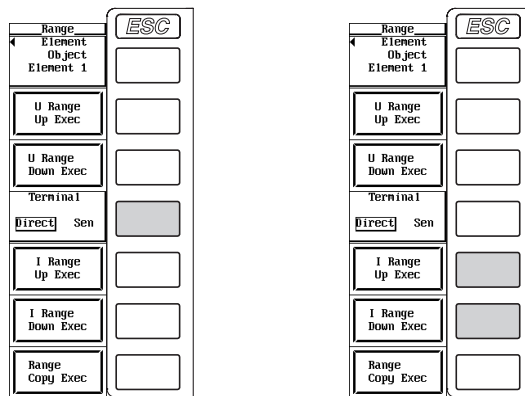

7. Repeat steps 2 to 6 to set the measurement range of all elements.

**Copying the Range**

The measurement range specified for a given element can be set to the elements of the same wiring unit. The measurement range for other elements that were specified before is not held.

3. Press one of the soft keys corresponding to the displayed element from which the range is to be copied (the copy source).
4. Press the **Range Copy Exec** soft key. The measurement range of the copy source is copied to the elements of the same wiring unit. However, if the wiring system is pattern 1, the measurement range is copied to all other elements.

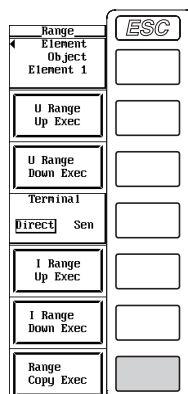

## 5.2 Setting the Measurement Range during Direct Input

### Explanation

#### Display Position of the Target Element and the Specified Range

The target element and the specified range are displayed at the upper right corner of the screen when RANGE is pressed.

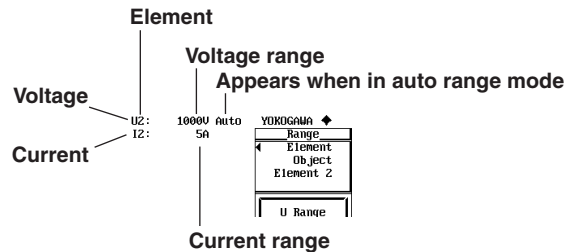

#### Selecting the Target Element to Be Specified

Only the installed elements are displayed. The Element menu is displayed according to the element configuration of the product.

#### Setting the Voltage and Current Ranges

There are two types of ranges, fixed range and auto range.

##### • Fixed range

- Voltage range
  - When the crest factor is set to 3  
Select 1.5 V, 3 V, 6 V, 10 V, 15 V, 30 V, 60 V, 100 V, 150 V, 300 V, 600 V, or 1000 V.
  - When the crest factor is set to 6  
Select 750 mV, 1.5 V, 3 V, 5 V, 7.5 V, 15 V, 30 V, 50 V, 75 V, 150 V, 300 V, or 500 V.
- Current range
  - For a 5-A input element
    - When the crest factor is set to 3  
Select 10 mA, 20 mA, 50 mA, 100 mA, 200 mA, 500 mA, 1 A, 2 A, or 5A.
    - When the crest factor is set to 6  
Select 5 mA, 10 mA, 25 mA, 50 mA, 100 mA, 250 mA, 500 mA, 1 A, or 2.5 A.
  - For a 50-A input element
    - When the crest factor is set to 3  
Select 1 A, 2 A, 5 A, 10 A, 20 A, or 50 A.
    - When the crest factor is set to 6  
Select 500 mA, 1 A, 2.5 A, 5 A, 10 A, or 25 A.

#### Note

- The range is set in reference to the RMS value of the input signal. For example, if a 100-Vrms sinusoid is to be applied, set the range to 100 V.
- The selectable current range varies depending on whether the installed element is a 5-A input element or a 50-A input element. Check the type of element that is installed in the product.

##### • Auto range

If you press the U Range Up Exec or the I Range Up Exec soft key when the range is at maximum, auto range is enabled. The range switches automatically depending on the amplitude of the input signal as follows. The different ranges used in the auto range are the same as those available for fixed range.

- Range increase
  - When the data of measurement function Urms or Irms exceeds 110% of the current measurement range, the range is increased.
  - When the peak value of the input signal exceeds 330% or 660% of the current measurement range when the crest factor is set to 3 or 6, respectively, the range is increased.
- Range decrease
 

When the data of the measurement function Urms or Irms is less than or equal to 30% of the measurement range and Upk and Ipk is less than or equal to 300% or 600% of the next lower range when the crest factor is set to 3 or 6, respectively, the range is decreased.

**Note**

When non-periodic pulse waveforms are applied during auto range, the range may not remain constant. In this case, use the fixed range setting.

**Power Range**

The measurement ranges (power ranges) of active power (P), apparent power (S), and reactive power (Q) are as follows.

Wiring System	Power Range
1P2W (single-phase, two-wire)	voltage range × current range
1P3W (single-phase three-wire)	voltage range × current range × 2
3P3W (three-phase three-wire)	(when the voltage and current ranges on the corresponding elements are set to the same range)
3V3A (three-voltage, three-current)	
3P4W (three-phase four-wire)	voltage range × current range × 3
	(when the voltage and current ranges on the corresponding elements are set to the same range)

- When the result of voltage range × current range exceeds 1000 W (VA or var), the displayed unit changes to kW (kVA or kvar).
- The display resolution is 60000.

**Note**

Because the voltage and current ranges switch independently according to range increase and decrease conditions in auto range mode, different power ranges may be set for the same power value.

**Copying Ranges**

The measurement range specified for a given element can be set to the elements of the same wiring unit. However, if the wiring system is pattern 1, the measurement range can be copied to all other elements.

- The measurement range for other elements that were specified before is not held.
- If the crest factor is set to 3 and a current range between 10 mA and 500 mA is specified on a 5-A input element and the range of this element is copied, the range for 50-A input elements is set to the minimum range for the 50-A input element (1 A). If the crest factor is set to 6 and a current range between 5 mA and 250 mA is specified on a 5-A input element and the range of this element is copied, the range for 50-A input elements is set to the minimum range for the 50-A input element (500 mA).
- If the crest factor is set to 3 and a current range between 10 A and 50 A is specified on a 50-A input element and the range of this element is copied, the range for 5-A input elements is set to the maximum range for the 5-A input element (5 A). If the crest factor is set to 6 and a current range between 5 A and 25 A is specified on a 50-A input element and the range of this element is copied, the range for 5-A input elements is set to the maximum range for the 5-A input element (2.5 A).

## 5.2 Setting the Measurement Range during Direct Input

The combinations of the actual voltage and current ranges and the power range are listed below according to the table on the previous page (when the voltage or current range of each element is set to the same range). The table shows the active power range (unit: W). The same ranges are set for apparent power (unit: VA) and reactive power (unit: var). Just replace the unit with VA or var when looking at the tables.

- When the crest factor is set to 3

**Effective Power Range of the Wiring Unit of Wiring System 1P2W or Each Element**

Current Range [A]	Voltage Range [V]											
	1.5000	3.0000	6.0000	10.000	15.000	30.000	60.000	100.00	150.00	300.00	600.00	1000.0
10.000m	15.000 mW	30.000 mW	60.000 mW	100.00 mW	150.00 mW	300.00 mW	600.00 mW	1.0000 W	1.5000 W	3.0000 W	6.0000 W	10.000 W
20.000m	30.000 mW	60.000 mW	120.00 mW	200.00 mW	300.00 mW	600.00 mW	1.2000 W	2.0000 W	3.0000 W	6.0000 W	12.000 W	20.000 W
50.000m	75.00 mW	150.00 mW	300.00 mW	500.00 mW	750.0 mW	1.5000 W	3.0000 W	5.0000 W	7.500 W	15.000 W	30.000 W	50.000 W
100.00m	150.00 mW	300.00 mW	600.00 mW	1.0000 W	1.5000 W	3.0000 W	6.0000 W	10.000 W	15.000 W	30.000 W	60.000 W	100.00 W
200.00m	300.00 mW	600.00 mW	1.2000 W	2.0000 W	3.0000 W	6.0000 W	12.000 W	20.000 W	30.000 W	60.000 W	120.00 W	200.00 W
500.00m	750.0 mW	1.5000 W	3.0000 W	5.0000 W	7.500 W	15.000 W	30.000 W	50.000 W	75.00 W	150.00 W	300.00 W	500.00 W
1.0000	1.5000 W	3.0000 W	6.0000 W	10.000 W	15.000 W	30.000 W	60.000 W	100.00 W	150.00 W	300.00 W	600.00 W	1.0000 kW
2.0000	3.0000 W	6.0000 W	12.000 W	20.000 W	30.000 W	60.000 W	120.00 W	200.00 W	300.00 W	600.00 W	1.2000 kW	2.0000 kW
5.0000	7.500 W	15.000 W	30.000 W	50.000 W	75.00 W	150.00 W	300.00 W	500.00 W	750.0 W	1.5000 kW	3.0000 kW	5.0000 kW
10.000	15.000 W	30.000 W	60.000 W	100.00 W	150.00 W	300.00 W	600.00 W	1.0000 kW	1.5000 kW	3.0000 kW	6.0000 kW	10.000 kW
20.000	30.000 W	60.000 W	120.00 W	200.00 W	300.00 W	600.00 W	1.2000 kW	2.0000 kW	3.0000 kW	6.0000 kW	12.000 kW	20.000 kW
50.000	75.00 W	150.00 W	300.00 W	500.00 W	750.0 W	1.5000 kW	3.0000 kW	5.0000 kW	7.500 kW	15.000 kW	30.000 kW	50.000 kW

**Effective Power Range of the Wiring Unit of Wiring System 1P3W, 3P3W, and 3V3A**

Current Range [A]	Voltage Range [V]											
	1.5000	3.0000	6.0000	10.000	15.000	30.000	60.000	100.00	150.00	300.00	600.00	1000.0
10.000m	30.000 mW	60.000 mW	120.000 mW	200.00 mW	300.00 mW	600.00 mW	1200.00 mW	2.0000 W	3.0000 W	6.0000 W	12.0000 W	20.000 W
20.000m	60.000 mW	120.000 mW	240.00 mW	400.00 mW	600.00 mW	1200.00 mW	2.4000 W	4.0000 W	6.0000 W	12.0000 W	24.000 W	40.000 W
50.000m	150.00 mW	300.00 mW	600.00 mW	1000.00 mW	1500.0 mW	3.0000 W	6.0000 W	10.0000 W	15.000 W	30.000 W	60.000 W	100.000 W
100.00m	300.00 mW	600.00 mW	1200.00 mW	2.0000 W	3.0000 W	6.0000 W	12.0000 W	20.000 W	30.000 W	60.000 W	120.000 W	200.00 W
200.00m	600.00 mW	1200.00 mW	2.4000 W	4.0000 W	6.0000 W	12.0000 W	24.000 W	40.000 W	60.000 W	120.000 W	240.00 W	400.00 W
500.00m	1500.0 mW	3.0000 W	6.0000 W	10.0000 W	15.000 W	30.000 W	60.000 W	100.000 W	150.00 W	300.00 W	600.00 W	1000.00 W
1.0000	3.0000 W	6.0000 W	12.0000 W	20.000 W	30.000 W	60.000 W	120.000 W	200.00 W	300.00 W	600.00 W	1200.00 W	2.0000 kW
2.0000	6.0000 W	12.0000 W	24.000 W	40.000 W	60.000 W	120.000 W	240.00 W	400.00 W	600.00 W	1200.00 W	2.4000 kW	4.0000 kW
5.0000	15.000 W	30.000 W	60.000 W	100.000 W	150.00 W	300.00 W	600.00 W	1000.00 W	1500.0 W	3.0000 kW	6.0000 kW	10.0000 kW
10.000	30.000 W	60.000 W	120.000 W	200.00 W	300.00 W	600.00 W	1200.00 W	2.0000 kW	3.0000 kW	6.0000 kW	12.0000 kW	20.000 kW
20.000	60.000 W	120.000 W	240.00 W	400.00 W	600.00 W	1200.00 W	2.4000 kW	4.0000 kW	6.0000 kW	12.0000 kW	24.000 kW	40.000 kW
50.000	150.00 W	300.00 W	600.00 W	1000.00 W	1500.0 W	3.0000 kW	6.0000 kW	10.0000 kW	15.000 kW	30.000 kW	60.000 kW	100.000 kW

**Effective Power Range of the Wiring Unit of Wiring System 3P4W**

Current Range [A]	Voltage Range [V]											
	1.5000	3.0000	6.0000	10.000	15.000	30.000	60.000	100.00	150.00	300.00	600.00	1000.0
10.000m	45.000 mW	90.000 mW	180.000 mW	300.00 mW	450.00 mW	900.00 mW	1800.00 mW	3.0000 W	4.5000 W	9.0000 W	18.0000 W	30.000 W
20.000m	90.000 mW	180.000 mW	360.00 mW	600.00 mW	900.00 mW	1800.00 mW	3.6000 W	6.0000 W	9.0000 W	18.0000 W	36.000 W	60.000 W
50.000m	225.00 mW	450.00 mW	900.00 mW	1500.00 mW	2250.0 mW	4.5000 W	9.0000 W	15.0000 W	22.500 W	45.000 W	90.000 W	150.000 W
100.00m	450.00 mW	900.00 mW	1800.00 mW	3.0000 W	4.5000 W	9.0000 W	18.0000 W	30.000 W	45.000 W	90.000 W	180.000 W	300.00 W
200.00m	900.00 mW	1800.00 mW	3.6000 W	6.0000 W	9.0000 W	18.0000 W	36.000 W	60.000 W	90.000 W	180.000 W	360.00 W	600.00 W
500.00m	2250.0 mW	4.5000 W	9.0000 W	15.0000 W	22.500 W	45.000 W	90.000 W	150.000 W	225.00 W	450.00 W	900.00 W	1500.00 W
1.0000	4.5000 W	9.0000 W	18.0000 W	30.000 W	45.000 W	90.000 W	180.000 W	300.00 W	450.00 W	900.00 W	1800.00 W	3.0000 kW
2.0000	9.0000 W	18.0000 W	36.000 W	60.000 W	90.000 W	180.000 W	360.00 W	600.00 W	900.00 W	1800.00 W	3.6000 kW	6.0000 kW
5.0000	22.500 W	45.000 W	90.000 W	150.000 W	225.00 W	450.00 W	900.00 W	1500.00 W	2250.0 W	4.5000 kW	9.0000 kW	15.0000 kW
10.000	45.000 W	90.000 W	180.000 W	300.00 W	450.00 W	900.00 W	1800.00 W	3.0000 kW	4.5000 kW	9.0000 kW	18.0000 kW	30.000 kW
20.000	90.000 W	180.000 W	360.00 W	600.00 W	900.00 W	1800.00 W	3.6000 kW	6.0000 kW	9.0000 kW	18.0000 kW	36.000 kW	60.000 kW
50.000	225.00 W	450.00 W	900.00 W	1500.00 W	2250.0 W	4.5000 kW	9.0000 kW	15.0000 kW	22.500 kW	45.000 kW	90.000 kW	150.000 kW

## 5.2 Setting the Measurement Range during Direct Input

- When the crest factor is set to 6

**Effective Power Range of the Wiring Unit of Wiring System 1P2W or Each Element**

Current Range [A]	Voltage Range [V]											
	750m	1.5000	3.0000	5.0000	7.5000	15.000	30.000	50.000	75.000	150.00	300.00	500.00
5.0000m	3.7500 mW	7.500 mW	15.000 mW	25.000 mW	37.500 mW	75.00 mW	150.00 mW	250.00 mW	375.00 mW	750.0 mW	1.5000 W	2.5000 W
10.000m	7.500 mW	15.000 mW	30.000 mW	50.000 mW	75.00 mW	150.00 mW	300.00 mW	500.00 mW	750.0 mW	1.5000 W	3.0000 W	5.0000 W
25.000m	18.750 mW	37.500 mW	75.00 mW	125.00 mW	187.50 mW	375.00 mW	750.0 mW	1.2500 W	1.8750 W	3.7500 W	7.500 W	12.500 W
50.000m	37.500 mW	75.00 mW	150.00 mW	250.00 mW	375.00 mW	750.0 mW	1.5000 W	2.5000 W	3.7500 W	7.500 W	15.000 W	25.000 W
100.00m	75.00 mW	150.00 mW	300.00 mW	500.00 mW	750.0 mW	1.5000 W	3.0000 W	5.0000 W	7.500 W	15.000 W	30.000 W	50.000 W
250.00m	187.50 mW	375.00 mW	750.0 mW	1.2500 W	1.8750 W	3.7500 W	7.500 W	12.500 W	18.750 W	37.500 W	75.00 W	125.00 W
500.00m	375.00 mW	750.0 mW	1.5000 W	2.5000 W	3.7500 W	7.500 W	15.000 W	25.000 W	37.500 W	75.00 W	150.00 W	250.00 W
1.0000	750.0 mW	1.5000 W	3.0000 W	5.0000 W	7.500 W	15.000 W	30.000 W	50.000 W	75.00 W	150.00 W	300.00 W	500.00 W
2.5000	1.8750 W	3.7500 W	7.500 W	12.500 W	18.750 W	37.500 W	75.00 W	125.00 W	187.50 W	375.00 W	750.0 W	1.2500 kW
5.0000	3.7500 W	7.500 W	15.000 W	25.000 W	37.500 W	75.00 W	150.00 W	250.00 W	375.00 W	750.0 W	1.5000 kW	2.5000 kW
10.000	7.500 W	15.000 W	30.000 W	50.000 W	75.00 W	150.00 W	300.00 W	500.00 W	750.0 W	1.5000 kW	3.0000 kW	5.0000 kW
25.000	18.750 W	37.500 W	75.00 W	125.00 W	187.50 W	375.00 W	750.0 W	1.2500 kW	1.8750 kW	3.7500 kW	7.500 kW	12.500 kW

**Effective Power Range of the Wiring Unit of Wiring System 1P3W, 3P3W, and 3V3A**

Current Range [A]	Voltage Range [V]											
	750m	1.5000	3.0000	5.0000	7.5000	15.000	30.000	50.000	75.000	150.00	300.00	500.00
5.0000m	7.5000 mW	15.000 mW	30.000 mW	50.000 mW	75.000 mW	150.00 mW	300.00 mW	500.00 mW	750.00 mW	1500.0 mW	3.0000 W	5.0000 W
10.000m	15.000 mW	30.000 mW	60.000 mW	100.000 mW	150.00 mW	300.00 mW	600.00 mW	1000.0 mW	1500.0 mW	3.0000 W	6.0000 W	10.0000 W
25.000m	37.500 mW	75.000 mW	150.00 mW	250.00 mW	375.00 mW	750.00 mW	1500.0 mW	2.5000 W	3.7500 W	7.5000 W	15.000 W	25.000 W
50.000m	75.000 mW	150.00 mW	300.00 mW	500.00 mW	750.00 mW	1500.0 mW	3.0000 W	5.0000 W	7.5000 W	15.000 W	30.000 W	50.000 W
100.00m	150.00 mW	300.00 mW	600.00 mW	1000.0 mW	1500.0 mW	3.0000 W	6.0000 W	10.000 W	15.000 W	30.000 W	60.000 W	100.000 W
250.00m	375.00 mW	750.00 mW	1500.0 mW	2.5000 W	3.7500 W	7.5000 W	15.000 W	25.000 W	37.500 W	75.000 W	150.00 W	250.00 W
500.00m	750.00 mW	1500.0 mW	3.0000 W	5.0000 W	7.5000 W	15.000 W	30.000 W	50.000 W	75.000 W	150.00 W	300.00 W	500.00 W
1.0000	1500.0 mW	3.0000 W	6.0000 W	10.000 W	15.000 W	30.000 W	60.000 W	100.000 W	150.00 W	300.00 W	600.00 W	1000.00 W
2.5000	3.7500 W	7.5000 W	15.000 W	25.000 W	37.500 W	75.000 W	150.00 W	250.00 W	375.00 W	750.00 W	1500.0 W	2.5000 kW
5.0000	7.5000 W	15.000 W	30.000 W	50.000 W	75.000 W	150.00 W	300.00 W	500.00 W	750.00 W	1500.0 W	3.0000 kW	5.0000 kW
10.000	15.000 W	30.000 W	60.000 W	100.000 W	150.00 W	300.00 W	600.00 W	1000.00 W	1500.0 W	3.0000 kW	6.0000 kW	10.000 kW
25.000	37.500 W	75.000 W	150.00 W	250.00 W	375.00 W	750.00 W	1500.0 W	2.5000 kW	3.7500 kW	7.5000 kW	15.000 kW	25.000 kW

**Effective Power Range of the Wiring Unit of Wiring System 3P4W**

Current Range [A]	Voltage Range [V]											
	750m	1.5000	3.0000	5.0000	7.5000	15.000	30.000	50.000	75.000	150.00	300.00	500.00
5.0000m	11.2500 mW	22.500 mW	45.000 mW	75.000 mW	112.500 mW	225.00 mW	450.00 mW	750.00 mW	1125.00 mW	2250.0 mW	4.5000 W	7.5000 W
10.000m	22.500 mW	45.000 mW	90.000 mW	150.000 mW	225.00 mW	450.00 mW	900.00 mW	1500.0 mW	2250.0 mW	4.5000 W	9.0000 W	15.0000 W
25.000m	56.250 mW	112.500 mW	225.00 mW	375.00 mW	562.50 mW	1125.00 mW	2250.0 mW	3.7500 W	5.6250 W	11.2500 W	22.500 W	37.500 W
50.000m	112.500 mW	225.000 mW	450.00 mW	750.00 mW	1125.00 mW	2250.0 mW	4.5000 W	7.5000 W	11.2500 W	22.500 W	45.000 W	75.000 W
100.00m	225.00 mW	450.00 mW	900.00 mW	1500.0 mW	2250.0 mW	4.5000 W	9.0000 W	15.0000 W	22.500 W	45.000 W	90.000 W	150.000 W
250.00m	562.50 mW	1125.00 mW	2250.0 mW	3.7500 W	5.6250 W	11.250 W	22.500 W	37.500 W	56.250 W	112.500 W	225.00 W	375.00 W
500.00m	1125.00 mW	2250.0 mW	4.5000 W	7.5000 W	11.2500 W	22.5000 W	45.000 W	75.000 W	112.500 W	225.00 W	450.00 W	750.00 W
1.0000	2250.0 mW	4.5000 W	9.0000 W	15.0000 W	22.500 W	45.000 W	90.000 W	150.000 W	225.00 W	450.00 W	900.00 W	1500.00 W
2.5000	5.6250 W	11.2500 W	22.500 W	37.500 W	56.250 W	112.500 W	225.00 W	375.00 W	562.50 W	1125.00 W	2250.0 W	3.7500 kW
5.0000	11.2500 W	22.500 W	45.000 W	75.000 W	112.500 W	225.00 W	450.00 W	750.00 W	1125.00 W	2250.0 W	4.5000 kW	7.5000 kW
10.000	22.500 W	45.000 W	90.000 W	150.000 W	225.00 W	450.00 W	900.00 W	1500.00 kW	2250.0 W	4.5000 kW	9.0000 kW	15.0000 kW
25.000	56.250 W	112.500 W	225.00 W	375.00 W	562.50 W	1125.00 W	2250.0 W	3.7500 kW	5.6250 kW	11.2500 kW	22.500 kW	37.500 kW

## 5.3 Setting the Measurement Range When Using an External Current Sensor

«For a functional description, see section 1.3.»

### Keys

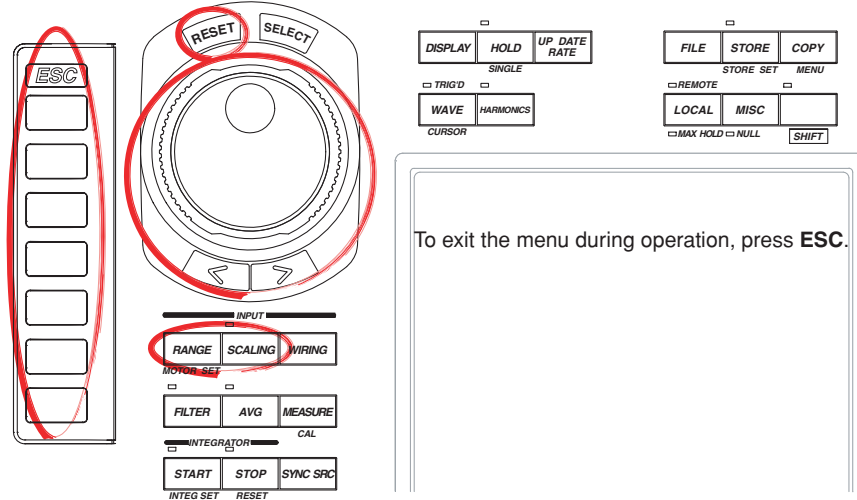

To exit the menu during operation, press **ESC**.

### Procedure

1. Press **RANGE** to display the Range menu.

#### Selecting the Target Element

2. Press the **Element Object** soft key to display the Element menu.  
Only the installed elements are displayed.
3. Press one of the soft keys corresponding to the displayed element to select the target element. The selected element is displayed at the upper right corner of the screen (if you selected element 1, U1 and I1 are displayed).

#### Selecting the Current Sensor Input Connector

4. Press the **Terminal** soft key to select Sen.

#### Setting the Current Sensor Range

5. Press the **I Range Up Exec** or **I Range Down Exec** soft key to set the current sensor range. The specified range is displayed by the element displayed at the upper right corner of the screen.
  - Pressing the I Range Up Exec soft key increases the current sensor range.  
If you press the I Range Up Exec soft key when the range is at maximum, auto range is enabled.
  - Pressing the I Range Down Exec soft key decreases the current sensor range.
6. Repeat steps 2 to 5 to set the current sensor range of all elements.

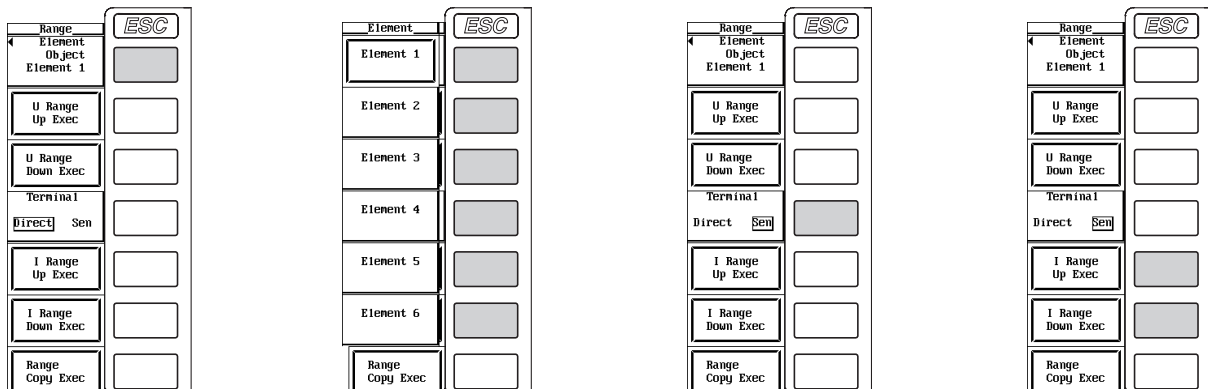

**Copying the Current Sensor Range**

The current sensor range specified for a given element can be set to the elements of the same wiring unit. The voltage range (see section 5.1) is also copied. The current sensor range for other elements that were specified before is not held.

3. Press one of the soft keys corresponding to the displayed element from which the information is to be copied (the copy source).
4. Press the **Range Copy Exec** soft key. The current sensor range and the voltage range of the copy source are copied to the elements of the same wiring unit. However, if the wiring system is pattern 1, the measurement range is copied to all other elements.

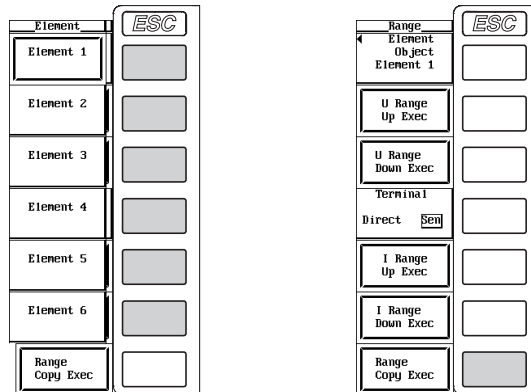

**Setting the Current Sensor Transformation Ratio**

1. Press **SCALING** to display the Scaling menu.
  - **Selecting the target element**  
If you are setting the current sensor transformation ratio on the same element that you entered the current sensor range, steps 2 and 3 are not necessary.
2. Press the **Element Object** soft key to display the Element menu.  
Only the installed elements are displayed.
3. Press one of the soft keys corresponding to the displayed element to select the target element. The selected element is displayed at the upper right corner of the screen (if you selected element 1, U1 and I1 are displayed).
- **Setting the current sensor transformation ratio**
4. Press the **Sensor Ratio(mV/A)** soft key.
5. Turn the **jog shuttle** to set the transformation ratio.  
For the procedures on how to enter values using the jog shuttle, see section 3.12, "Entering Values and Strings."

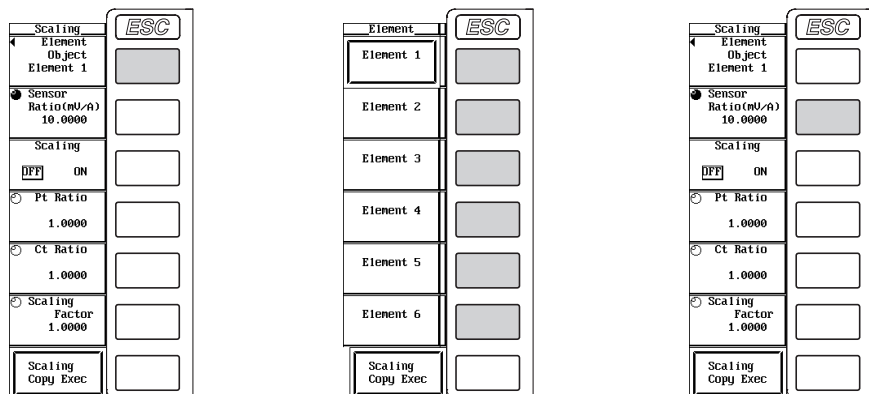

### 5.3 Setting the Measurement Range When Using an External Current Sensor

- **Copying the current sensor transformation ratio**

The current sensor transformation ratio specified for a given element can be set to the elements of the same wiring unit. The ON/OFF condition, PT ratio, CT ratio, and power coefficient (see section 5.4) of the scaling function area also copied. The current sensor transformation ratio and the ON/OFF condition, PT ratio, CT ratio, and power coefficient of the scaling function for other elements that were specified before are not held.

3. Press one of the soft keys corresponding to the displayed element from which the information is to be copied (the copy source).
4. Press the **Scaling Copy Exec** soft key. The current sensor transformation ratio and the ON/OFF condition, PT ratio, CT ratio, and power coefficient of the scaling function of the copy source are copied to the elements of the same wiring unit. However, if the wiring system is pattern 1, the measurement range is copied to all other elements.

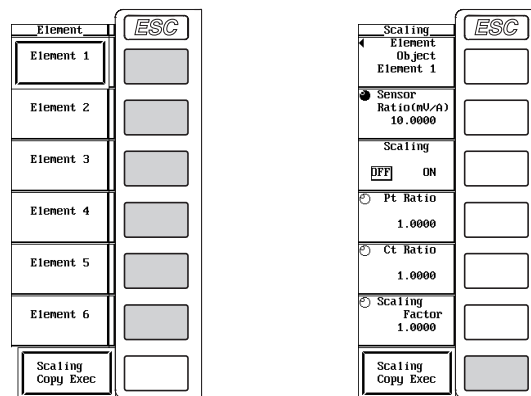

#### Explanation

The output of current sensors, such as shunts and clamps, can be input to the current sensor input connector of an element and be measured.

#### Display Position of the Target Element and Specified Range

It is the same as section 5.2, "Setting the Measurement Range during Direct Input."

#### Selecting the Current Sensor Input Connector

To measure the current using the input signal from the current sensor input connector, Sen must be selected for the Terminal in the Range menu and then the current sensor range and current sensor transformation ratio must be specified.

#### Selecting the Current Sensor Range

Two types of range settings are available: fixed range and auto range.

- **Fixed range**

- When the crest factor is set to 3  
Select 50 mV, 100 mV, 250 mV, 500 mV, 1 V, 2 V, 5 V, or 10 V.
- When the crest factor is set to 6  
Select 25 mV, 50 mV, 125 mV, 250 mV, 500 mV, 1 V, 2.5 V, 5 V.

- **Auto range**

Select Auto for range setting to enable auto range. The range changes automatically depending on the amplitude of the input signal. The switching conditions and precautions are the same as the descriptions given in section 5.2, "Setting the Measurement Range during Direct Input. The different ranges used in the auto mode are the same as those available for fixed range.



#### Copying the Current Sensor Range

The current sensor range specified for a given element can be set to the elements of the same wiring unit. However, if the wiring system is pattern 1, the measurement range can be copied to all other elements.

- The voltage range (see section 5.2) is also copied.
- The current sensor range for other elements that were specified before is not held.

#### Setting the Current Sensor Transformation Ratio

The ratio can be set in the range of 0.0001 to 99999.9999.

#### Copying the Current Sensor Transformation Ratio

The current sensor transformation ratio specified for a given element can be set to the elements of the same wiring unit. However, if the wiring system is pattern 1, the measurement range can be copied to all other elements.

- The ON/OFF condition, PT ratio, CT ratio, and power coefficient (see section 5.4) of the scaling function area also copied.
- The current sensor transformation ratio and the ON/OFF condition, PT ratio, CT ratio, and power coefficient of the scaling function for other elements that were specified before are not held.

#### Configuration Example of the Current Sensor Range and Transformation Ratio

When measuring a current with a maximum value of 100 A using a current sensor that outputs 10 mV when 1 A of current is flowing, the equation becomes  $10 \text{ mV/A} \times 100 \text{ A} = 1 \text{ V}$ . Therefore, set 1 V for the current sensor range and 10 mV/A for the current sensor transformation ratio.

#### Note

---

When attempting to directly read the current of the circuit under measurement by multiplying the output of the external current sensor by the transformation ratio, turn OFF the external PT/CT scaling function (see section 5.4). If it is turned ON, the value will be multiplied by the CT ratio.

---

## 5.4 Setting the Scaling Function When Using an External PT or CT

«For a functional description, see section 1.3.»

### Keys

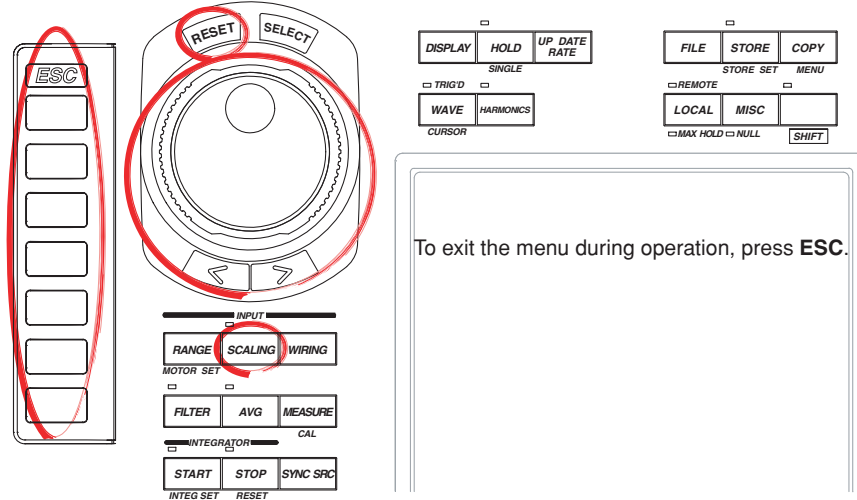

### Procedure

1. Press **SCALING** to display the Scaling menu.

#### Selecting the Target Element

2. Press the **Element Object** soft key to display the Element menu.  
Only the installed elements are displayed.
3. Press one of the soft keys corresponding to the displayed element to select the target element.

#### Turning ON/OFF the Scaling Function

4. Press the **Scaling** soft key to select ON or OFF. If any of the target elements is turned ON, the SCALING indicator above and to the left of the key illuminates.

#### Setting the PT Ratio

4. Press the **Pt Ratio** soft key.
5. Turn the **jog shuttle** to set the PT ratio.

For the procedures on how to enter values using the jog shuttle, see section 3.12, "Entering Values and Strings."

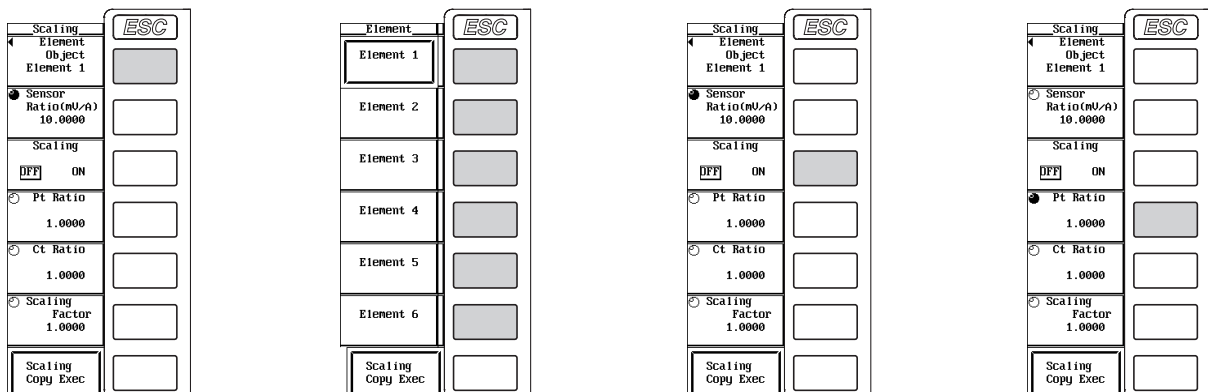

**Setting the CT Ratio**

4. Press the **Ct Ratio** soft key.
5. Turn the **jog shuttle** to set the CT ratio.

For the procedures on how to enter values using the jog shuttle, see section 3.12, "Entering Values and Strings."

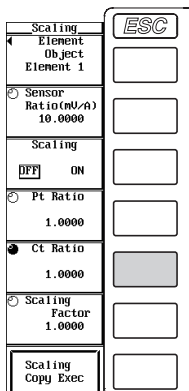

**Setting the Power Coefficient**

4. Press the **Scaling Factor** soft key.
5. Turn the **jog shuttle** to set the power coefficient.

For the procedures on how to enter values using the jog shuttle, see section 3.12, "Entering Values and Strings."

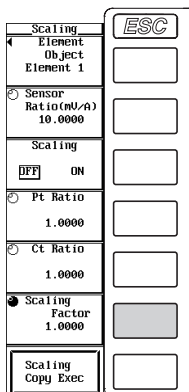

**Copying the ON/OFF Condition, PT Ratio, CT Ratio, and Power Coefficient of the Scaling Function**

The ON/OFF condition, PT ratio, CT ratio, and power coefficient of the scaling function specified for a given element can be set to the elements of the same wiring unit. The current sensor transformation ratio (see section 5.3) is also copied. The current the ON/OFF condition, PT ratio, CT ratio, and power coefficient of the scaling function and the current sensor transformation ratio for other elements that were specified before are not held.

3. Press one of the soft keys corresponding to the displayed element from which the information is to be copied (the copy source).
4. Press the **Scaling Copy Exec** soft key. The current the ON/OFF condition, PT ratio, CT ratio, and power coefficient of the scaling function and the sensor transformation ratio of the copy source are copied to the elements of the same wiring unit. However, if the wiring system is pattern 1, the measurement range is copied to all other elements.

## 5.4 Setting the Scaling Function When Using an External PT or CT

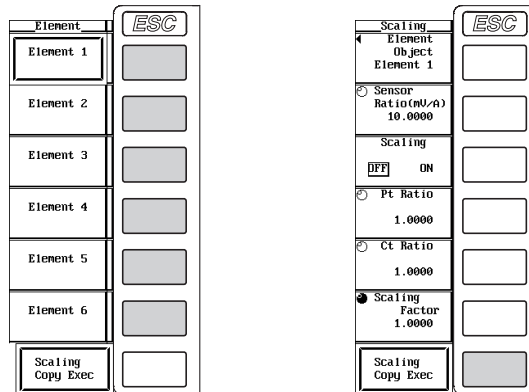

### Explanation

Measurements can be made by connecting the output of the secondary side of the PT and the output of the secondary side of the CT to the same voltage and current input terminals that are used when directly inputting a signal.

### Turning ON/OFF the Scaling Function

You can select whether to multiply the voltage U, current I, and power (P, S, and Q) by the PT ratio, CT ratio, and power coefficient respectively. If any of the target elements is turned ON, the SCALING indicator above and to the left of the key illuminates.

- ON : The voltage U, current I, and power (P, S, and Q) are multiplied by the PT ratio, CT ratio, and power coefficient.
- OFF : The voltage U, current I, and power (P, S, and Q) are not multiplied by the PT ratio, CT ratio, and power coefficient. The output values of the external PT and CT are read directly as numerical data in this case.

### Setting the PT Ratio

The ratio can be set in the range of 0.0001 to 99999.9999.

### Setting the CT Ratio

The ratio can be set in the range of 0.0001 to 99999.9999.

### Setting the Power Coefficient

The ratio can be set in the range of 0.0001 to 99999.9999.

### Note

If the result of multiplying the PT ratio, CT ratio, or power coefficient (scaling factor) to the measurement range exceeds 99999M, the display frame of the numerical data will display [-OF-].

# 5.5 Selecting the Input Filter

«For a functional description, see section 1.3.»

## Keys

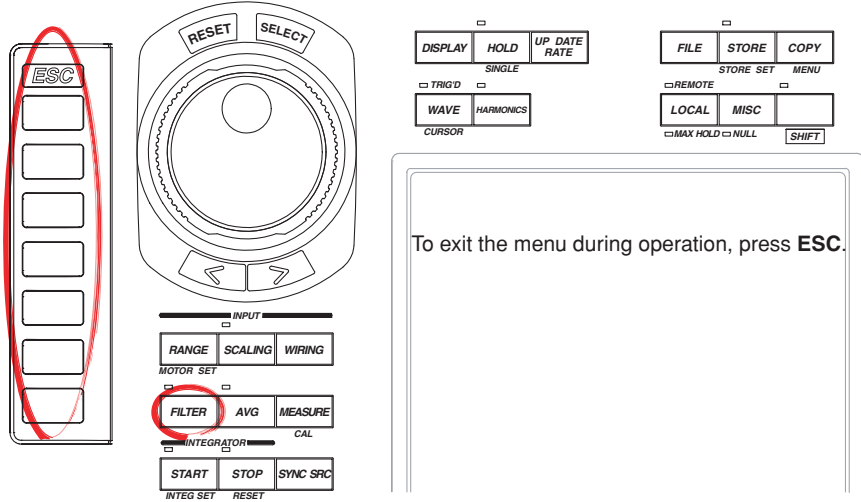

## Procedure

1. Press **FILTER** to display the Filter menu.

### Selecting the Target Element

2. Press the **Element Object** soft key to display the Element menu.  
Only the installed elements are displayed.
3. Press one of the soft keys corresponding to the displayed element to select the target element.

### Selecting the Line Filter

4. Press the **Line Filter** soft key to select the filter from OFF to 5.5k. If any of the target elements is set to a setting other than OFF, the FILTER indicator above and to the left of the key illuminates.

### Selecting the Zero Crossing Filter

4. Press the **Zero Cross Filter** soft key to select OFF or 500.

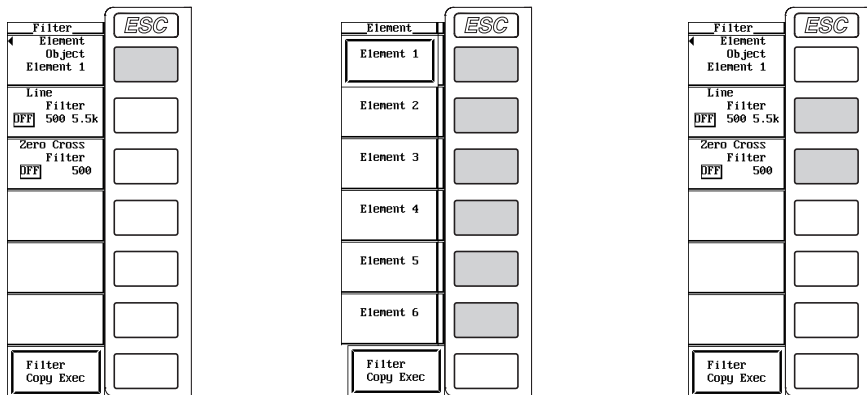

## 5.5 Selecting the Input Filter

### Copying the Input Filter

The input filter specified for a given element can be set to the elements of the same wiring unit. The input filters for other elements that were specified before is not held.

3. Press one of the soft keys corresponding to the displayed element from which the information is to be copied (the copy source).
4. Press the **Filter Copy Exec** soft key. The input filter of the copy source is copied to the elements of the same wiring unit. However, if the wiring system is pattern 1, the measurement range is copied to all other elements.

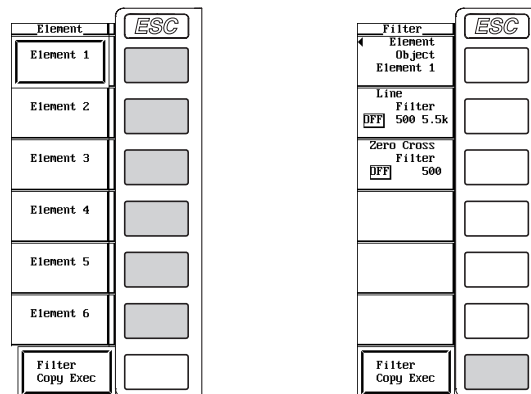

### Explanation

There are two types of filters.

### Selecting the Line Filter

The line filter is inserted into the circuit under measurement. It removes the noise from the inverter and from distorted waveforms.

- The cutoff frequency can be selected from the list of choices below.  
OFF, 500 Hz, and 5.5 kHz
- If any of the target elements is set to a setting other than OFF, the FILTER indicator above and to the left of the key illuminates.
- Selecting OFF disables the filter.

### Selecting the Zero Crossing Filter

This filter is inserted only into the frequency measurement circuit. Zero crossing refers to the point at which the input signal crosses the center level of the amplitude. This filter is used to accurately detect the zero crossing point.

- The cutoff frequency can be selected from the list of choices below.  
OFF and 500 Hz
- This instrument detects the zero crossing point with a hysteresis of approximately 5% of the measurement range.
- When the zero crossing filter is OFF and the line filter (above) is ON, the cutoff frequency specified by the line filter is used as a zero crossing filter.

### Note

For selecting the line filter for the motor evaluation function, see section 8.3.

# 5.6 Averaging

«For a functional description, see section 1.3.»

## Keys

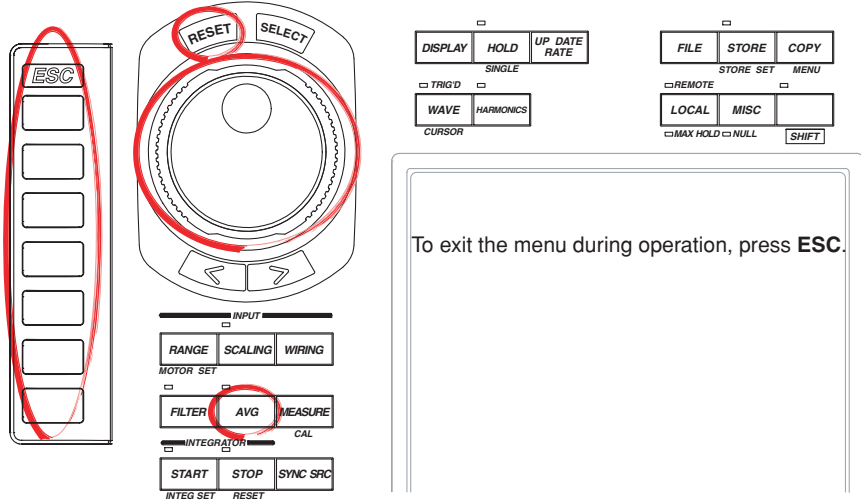

## Procedure

### During Normal Measurement

1. Press **AVG** to display the Avg menu.

### Turning ON/OFF the Averaging Function

2. Press the **Averaging** soft key to select ON or OFF.

### Selecting the Averaging Type

3. Press the **Avg Type** soft key to select Exp or Lin.

### Setting the Attenuation Constant or the Average Count

4. Press the **Count** soft key.
5. Turn the **jog shuttle** to set the attenuation constant or the average count.
  - For the procedures on how to enter values using the jog shuttle, see section 3.12, "Entering Values and Strings."
  - If the averaging type is Exp (exponential averaging), set the attenuation constant. If the averaging type is Lin (moving averaging), set the average count.

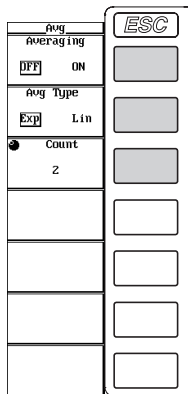

### During Harmonic Measurement

If Mode is turned ON in the Harmonics menu (see section 7.1), the instrument enters the harmonic measurement mode.

1. Press **AVG** to display the Avg menu.

#### Turning ON/OFF the Averaging Function

2. Press the **Averaging** soft key to select ON or OFF.

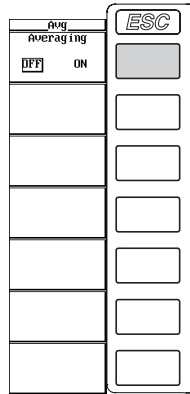

#### Explanation

The averaging function is effective when reading of the numerical display is difficult due to fluctuations. This occurs when the fluctuation of the power supply or the load is large or when the input signal frequency is low.

### During Normal Measurement

#### Turning ON/OFF Averaging

You can select whether to perform the specified averaging operation.

- ON: Performs averaging.
- OFF: Does not perform averaging.

#### Selecting the Averaging Type

Select one of the following list of choices. For the equation of each type, see section 1.3.

- Exp: Performs exponential averaging.
- Lin: Performs moving averaging.

#### Setting the Attenuation Constant or Average Count

If the averaging type is Exp (exponential averaging), set the attenuation constant. If the averaging type is Lin (moving averaging), set the average count.

- For Exp: Select the attenuation constant from 2, 4, 8, 16, 32, and 64.
- For Lin: Select the average count from 8, 16, 32, 64, 128, and 256.

#### Measurement Functions That Are Averaged

The measurement functions that are directly averaged are shown below. Other functions that use these functions in their computation are also affected by the averaging. For details regarding the determination of each measurement function, see appendix 1.

- Urms, Irms, Umn, Imn, Udc, Idc, and P
- Torque and speed are also measured when the motor evaluation function option (/MTR) is installed.



## During Harmonic Measurement

If Mode is turned ON in the Harmonics menu (see section 7.1), the instrument enters the harmonic measurement mode.

When the fundamental frequency is 50/60 Hz, the attenuation constant is automatically adjusted so that a first-order low-pass filter with a time constant of 1.5 s is achieved. Exponential averaging is performed using this attenuation constant. For example, if the data length for the analysis is 8192 and the fundamental frequency of the PLL source is between 55 Hz and 75 Hz, the attenuation constant is set to 5.625. For other frequencies, it is set to 4.6875.

### Turning ON/OFF Averaging

You can select whether to perform the specified averaging operation.

- ON: Performs averaging.
- OFF: Does not perform averaging.

### Measurement Functions That Are Averaged

The measurement functions that are directly averaged are shown below. Other functions that use these functions in their computation are also affected by the averaging. For details regarding the determination of each measurement function, see appendix 1.

$U(k)$ ,  $I(k)$ ,  $P(k)$ , and  $Q(k)$

\*  $k$ : harmonic order

### Note

- The following measurement functions are not affected by averaging.
    - During normal measurement
      - $f_U$ ,  $f_I$ ,  $U_{+pk}$ ,  $U_{-pk}$ ,  $I_{+pk}$ ,  $I_{-pk}$ , Time,  $W_p$ ,  $W_{p+}$ ,  $W_{p-}$ ,  $q$ ,  $q_{+}$ ,  $q_{-}$ ,  $W_{p\Sigma}$ ,  $W_{p+\Sigma}$ ,  $W_{p-\Sigma}$ ,  $q\Sigma$ ,  $q_{+\Sigma}$ , and  $q_{-\Sigma}$
    - During harmonic measurement
      - $\phi_U(k)$ ,  $\phi_I(k)$ ,  $\phi_{U1-U2}$ ,  $\phi_{U1-U3}$ ,  $\phi_{U1-I1}$ ,  $\phi_{U1-I2}$ , and  $\phi_{U1-I3}$
- \*  $k$ : harmonic order

## 5.7 Changing the Data Update Rate

«For a functional description, see section 1.3.»

### Keys

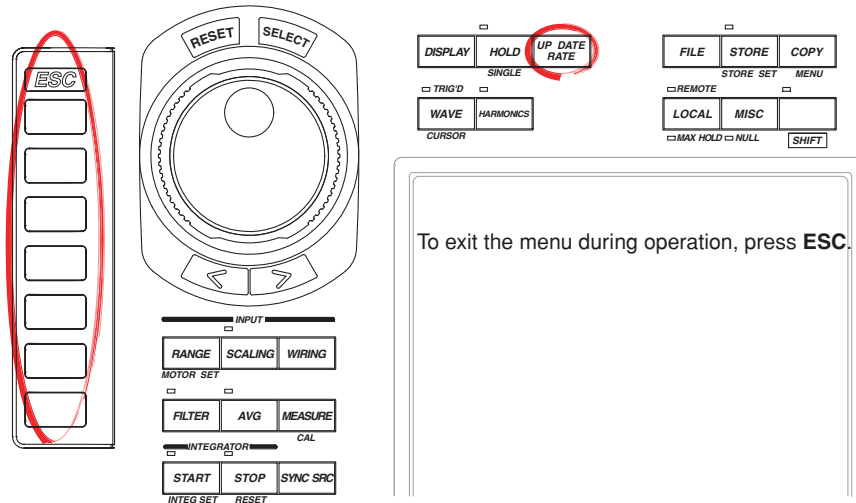

To exit the menu during operation, press **ESC**.

### Procedure

#### During Normal Measurement

1. Press **UPDATE RATE** to display the Update Rate menu.
2. Press the **Update Rate Up Exec** or **Update Rate Down Exec** soft key to change the data update rate. The specified data update rate is displayed at the upper right corner of the screen.
  - Pressing the Update Rate Up Exec soft key increases data update rate.
  - Pressing the Update Rate Down Exec soft key decreases data update rate.

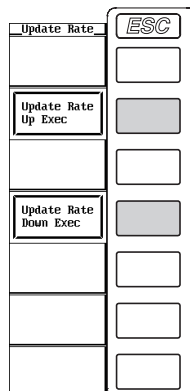

#### During Harmonic Measurement

The data update rate is determined by the fundamental frequency of the PLL source and the number of periods of the PLL source used for the analysis. You can not change the data update rate from the Update Rate menu described in this section. For detailed values, see section 17.6, "Functions."

**Explanation**

The data update rate refers to the interval in which the sampled data used to determine the measurement functions is retrieved. When the retrieval of waveform display data is OFF during normal measurement, the D/A output, communication output, or storing (to the internal memory) of the numerical data is carried out using this interval.

**Display Position of the Data Update Rate**

The data update rate is displayed at the upper right corner of the screen when UPDATE RATE is pressed.

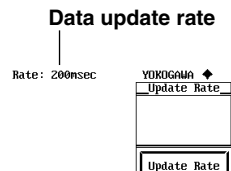
**During Normal Measurement**

You can select from the following choices. The numerical data is updated at the selected period. You can increase the data update rate to acquire relatively fast load fluctuations in the power system or decrease the rate to acquire sampled data for several periods even for relatively long signals.

50 ms, 100 ms, 200 ms, 500 ms, 1 s, 2 s, and 5 s

**During Normal Measurement**

The data update rate is determined by the fundamental frequency of the PLL source and the number of periods of the PLL source used for the analysis. You can not change the data update rate from the Update Rate menu described in this section. For detailed values, see section 17.6, "Functions."

**Note**

The update rate of the numerical data and waveform data that are displayed on the screen may take longer than the data update rate.

## 5.8 Holding the Display and Performing Single Measurements

«For a functional description, see section 1.3.»

### Keys

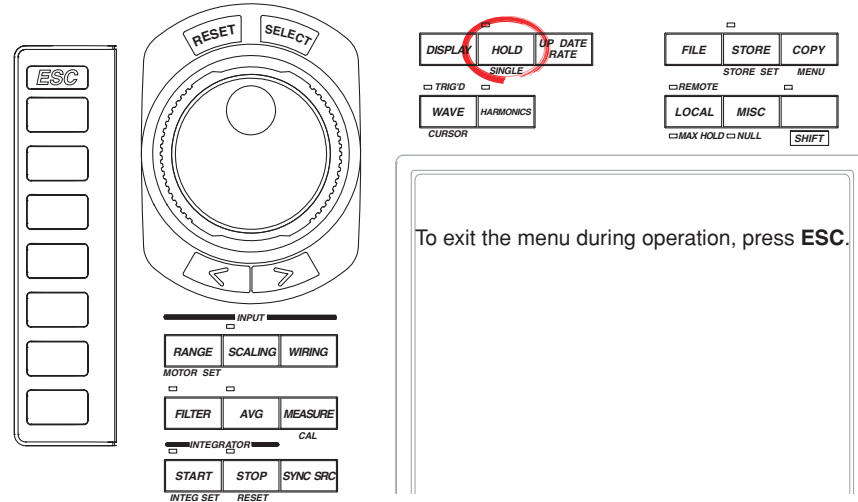

### Procedure

#### Holding the Numerical Data Display

1. Press **HOLD**. The HOLD indicator above and to the left of the key illuminates, and the numerical data display is held.

#### Performing a Single Measurement

2. Press **SHIFT+HOLD (SINGLE)**. The measurement is performed once and the instrument enters the held condition.

#### Releasing the Held Condition

3. Press **HOLD** while the values are held. The HOLD indicator turns OFF, and the numerical data display is updated.

### Explanation

#### Hold

This function aborts the measurement-display operation that is performed at the data update rate and holds the data display of the various functions. The D/A output, the numerical data list that the built-in printer prints, the communication output, and other values are set to the held numerical data.

#### Single Measurement

While in the held condition, the measurement is performed once at the specified data update rate and enters the held condition.

#### Note

For details on the hold function during integration, see section 6.11.

## 5.9 Holding the Numerical Data Display at the Maximum

«For a functional description, see section 1.3.»

### Keys

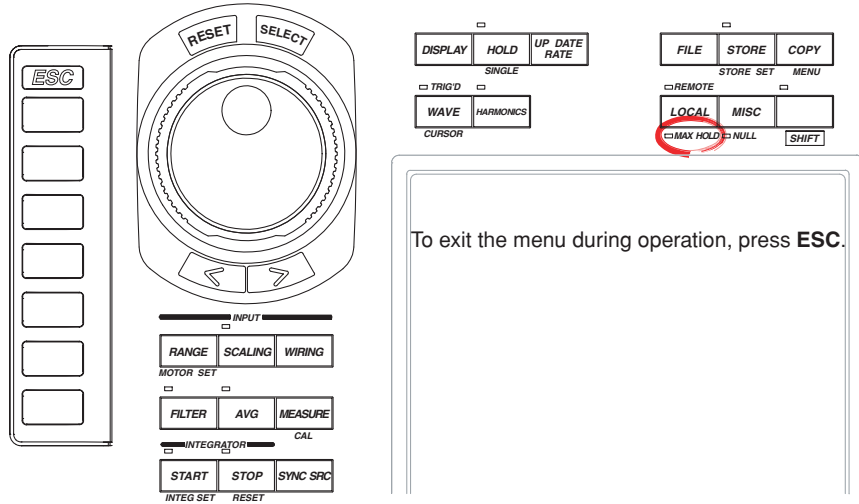

### Procedure

#### Holding the Numerical Data Display at the Maximum

1. Press **SHIFT+LOCAL (MAX HOLD)**. The MAX HOLD indicator above and to the left of the key illuminates, and the numerical data display is held at the maximum.

#### Releasing the MAX Held Condition

2. Press **SHIFT+LOCAL (MAX HOLD)** when the MAX HOLD indicator above and to the left of the key is illuminated. The MAX HOLD indicator turns OFF and MAX hold is released.

### Explanation

#### MAX Hold

This function enables the maximum value of the numerical data to be held.

- Holds the data of measurement functions Urms, Umn, Udc, Uac, Irms, Imn, Idc, Iac, P, S, Q, U+pk, U-pk, I+pk, and I-pk as well as the data of the  $\Sigma$  function of these functions while the MAX hold function is enabled.
- The D/A output, the numerical data list that the built-in printer prints, the communication output, and other values are set to the maximum held values.

## 5.10 Performing Master/Slave Synchronized Measurements

«For a functional description, see section 1.3.»

### Keys

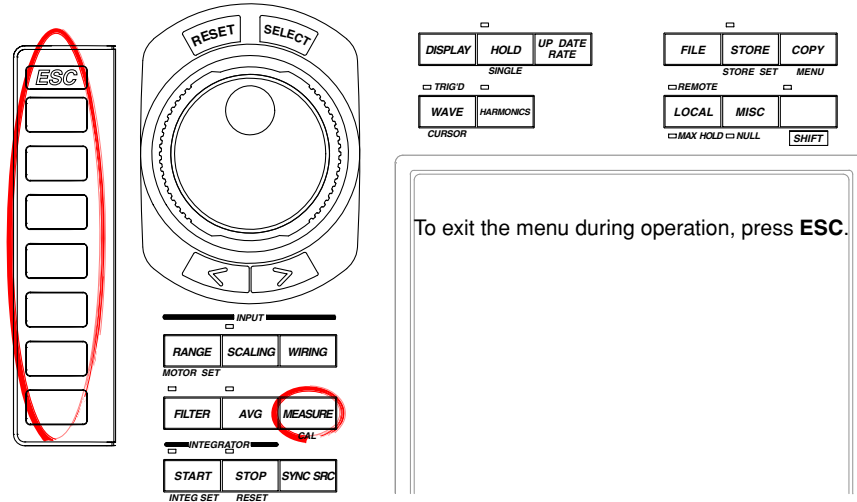

### Procedure

#### Setting the Instrument to be a Master or a Slave

1. Press **MEASURE** to display the Measure menu.
  2. Press the **Sync Measure** soft key to select Master or Slave.
- Only a single master and a single slave can be specified.

#### During normal measurement

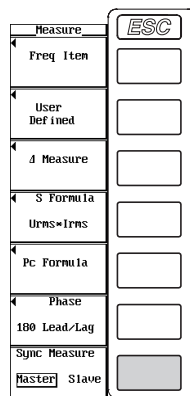

#### During harmonic measurement

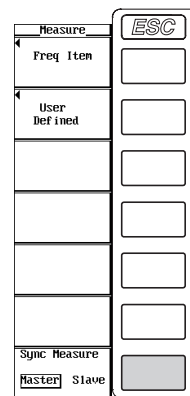

#### Performing Synchronized Measurements

Connect the external start signal input/output connectors between the master and slave instruments using BNC connectors (sold separately) and do the same for the external stop signal input/output connectors.

- The slave instrument starts its measurement at approximately the same time as the start of the measurement on the master instrument.
- The slave instrument stops its measurement at approximately the same time as the stop of the measurement on the master instrument.

**Explanation**

With the master instrument outputting measurement start and stop signals and the slave instrument receiving those signals, synchronized measurement on two instruments is achieved.

**External Start/Stop Signal Input/Output Connector**

Connect the external start signal input/output connectors on the rear panel between the master and slave instruments using BNC connectors (sold separately) and do the same for the external stop signal input/output connectors.

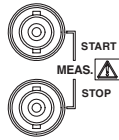

Item	Specification	Notes
Connector type	BNC connector	Common to master and slave
I/O level	TTL	Common to master and slave
Output logic	⌋ (Negative), falling edge	Applies to the master
Measurement start delay time	Within (100 ns + 1 sample period)	Applies to the master
Output hold time	Low level, 200 ns or more	Applies to the master
Input logic	⌋ (Negative), falling edge	Applies to the slave
Minimum pulse width	Low level, 200 ns or more	Applies to the slave
Input delay time	Within (100 ns + 1 sample period)	Applies to the slave

**Note**

Synchronized measurement is unavailable in the following situations.

- when either master, slave, or both are in harmonic measurement mode.
- when the data update rate or retrieval of waveform display data ON/OFF setting for the master is different from that of the slave.
- when real-time integration mode or store is in real-time mode.

**Output Circuit for the External Start/Stop Signal and Time Chart**

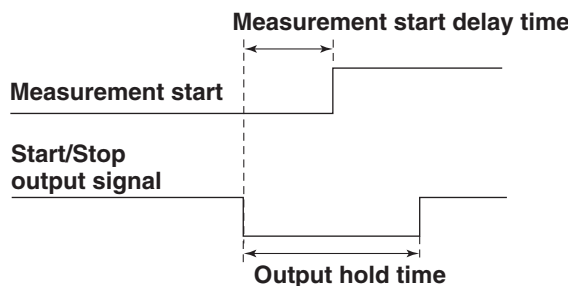
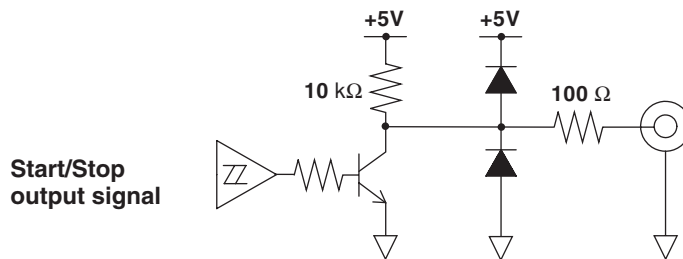

## 5.10 Performing Master/Slave Synchronized Measurements

### Input Circuit for the External Start/Stop Signal and Time Chart

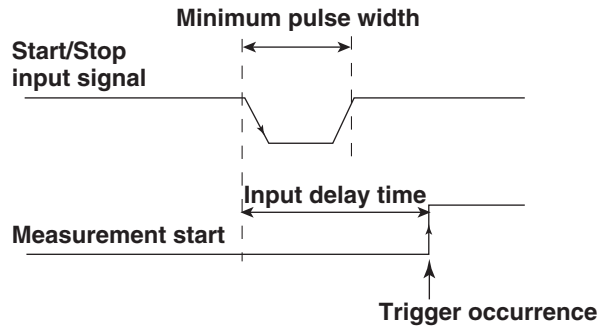
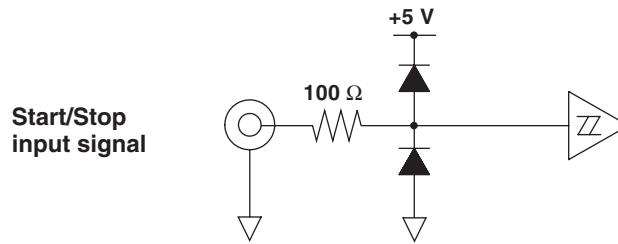

#### **CAUTION**

- When the instrument is set to master, do not apply external voltage to the external start/stop signal input/output connector (START/STOP). This may cause damage to the instrument.
- Applying a voltage outside the 0 to 5 V range to the external start/stop signal input/output connector when the instrument is set to slave may cause damage to the instrument.



## 5.11 Selecting the Crest Factor

### Keys

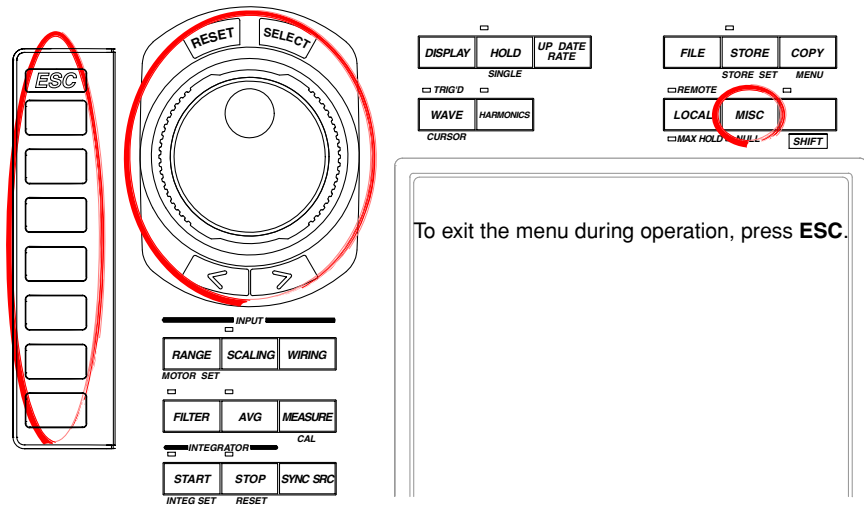

### Procedure

1. Press **MISC** to display the Misc menu.
  2. Press the **Config** soft key to display the Config menu.
- **Selecting the Crest Factor**
    3. Press **Crest Factor** to select CF3 or CF6.

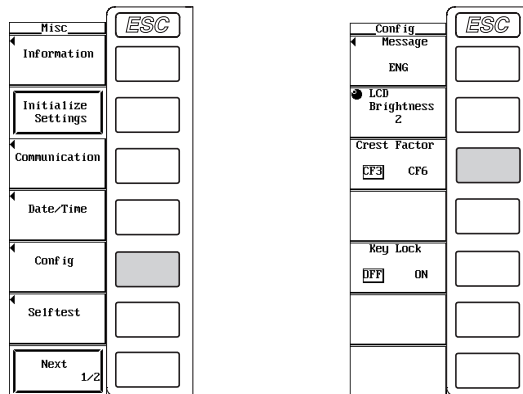

### Explanation

#### Selecting the Crest Factor

The crest factor is a ratio of the peak to the rms value.  
You can select CF3 or CF6.

#### Note

If you set the crest factor to 6, the voltage range and current range are set to the maximum range on all elements.

If you set the crest factor to 6, the measurement conditions of crest factor 5 and higher required by IEC 62018 are met.

# 6.1 Changing the Displayed Item of Numerical Data

## Keys

«For a functional description, see section 1.4.»

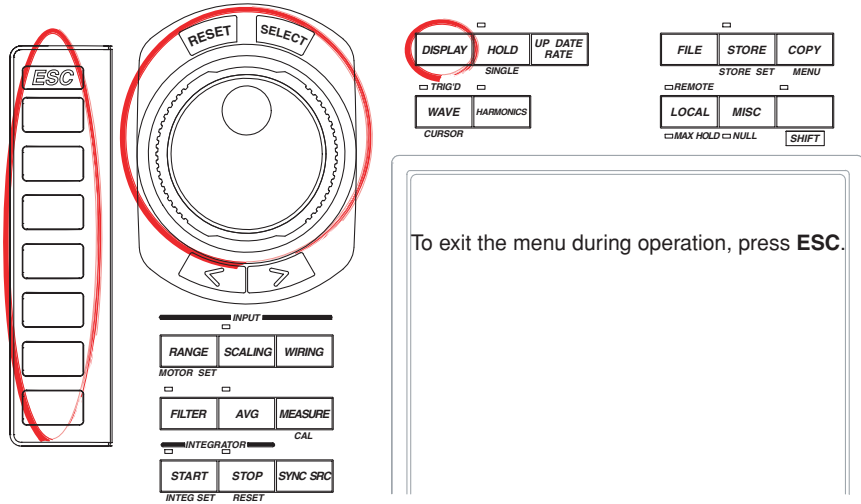

## Procedure

**Check that the measurement mode is set to normal measurement. If the measurement mode is set to harmonic measurement, set Mode to OFF in the Harmonics menu (see section 7.1).**

1. Press **DISPLAY** to display the Display menu.  
 Check that Format (display format) is set to Numeric, Numeric+Wave, or Numeric+Trend. For details on setting the display format, see section 4.1.  
 Check that Item Amount (number of displayed items) is set to 4 (2), 8 (4), 16 (8), 42 (21), or 78 (39). For details on setting the number of displayed items, see section 4.1.

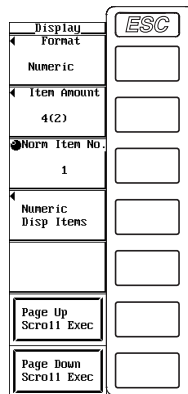

## 6.1 Changing the Displayed Item of Numerical Data

The following procedures are given for a representative example in which the display format is set to Numeric.

2. Press the **Numeric Disp Items** soft key to display the Numeric Items menu.

### Selecting the Item to Be Changed

3. Turn the **jog shuttle** to select the item to be changed. The item to be changed is highlighted.

### Changing the Measurement Function

4. Press the **Function** soft key to display the measurement function selection box.
5. Turn the **jog shuttle** to select any of the measurement function starting with None.
6. Press **SELECT**. The symbol for the selected measurement function and the numerical data are displayed at the highlighted position.

### Changing the Element/Wiring Unit

7. Press the **Element** soft key to display the element/wiring unit selection box.
8. Turn the **jog shuttle** to select any of the elements/wiring units starting with Element1.
9. Press **SELECT**. The symbol for the selected element number or wiring unit and the numerical data are displayed at the highlighted position.

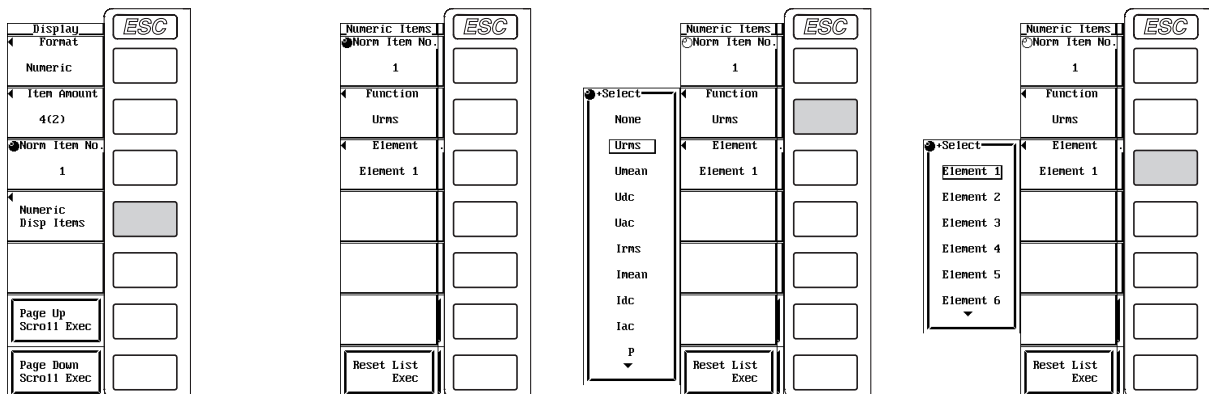

### Resetting the Order of the Displayed Items

3. Press the **Reset List Exec** soft key. The Alert dialog box is displayed.
4. Turn the **jog shuttle** to select OK or Cancel.
5. Select OK and press **SELECT** to execute the reset of the order of the displayed items. Select Cancel and press **SELECT** to abort the reset of the order of the displayed items.

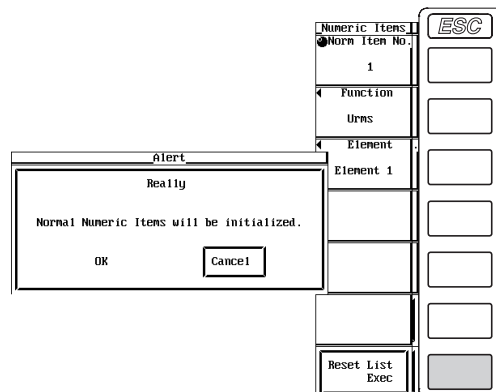

## Explanation

## Changing the measurement function

- The types of measurement functions that can be selected are the items that are indicated in “Measurement Function Types during Normal Measurement” and “Measurement Function Types for Motor Evaluation Function (Option)” in section 1.2; “Delta Computation,” “User-Defined Functions,” and “Corrected Power” in section 1.5; and “Measurement Functions of Integration” in section 1.6.
- You can also select not to display the measurement functions (None).
- The number (1, 2, 3, and 4) that is attached to the measurement function symbol of the delta computation has no relation to the element number. For delta computation with only a single measurement function, a fixed number is displayed regardless of the element selected in the next section. For delta computation with multiple measurement functions (voltage), Element1 through Element3 (selected in the next section) correspond to the numbers 1 through 3 that are attached to the measurement functions of the delta computation regardless of the element specified as the delta computation target.
- The number attached to the user-defined function F1 to F4 is a portion of the measurement function symbol. It is not related to the element number.

## Changing the Element/Wiring Unit

- You can select the element/wiring unit from the following list of choices. The selectable items vary depending on the installed elements.  
Element1, Element2, Element3, Element4, Element5, Element6,  
 $\Sigma A$ ,  $\Sigma B$ , and  $\Sigma C$
- If there are no elements that are assigned to the selected wiring unit, there is no numerical data. Thus, [-----] (no data) is displayed in this case. For example, if elements are assigned to  $\Sigma A$  and  $\Sigma B$  and no elements are assigned to  $\Sigma C$ , then the measurement function for  $\Sigma C$  shows [-----] (no data).

Urms1	5.0517 V		Urms1	5.0517 V
Umn1	5.0516 V		Umn1	5.0516 V
Udc1	-0.0315 V	Change the element of the third item →	Umn1	5.0516 V
Uac1	5.0516 V		Uac1	5.0516 V
Irms1	5.0530 A		Irms1	5.0530 A
Imn1	5.0551 A		Imn1	5.0551 A
		Change the measurement function of the third item →	Urms1	5.0517 V
			Umn1	5.0516 V
			Udc2	-0.0307 V
			Uac1	5.0516 V
			Irms1	5.0530 A
			Imn1	5.0551 A

## Resetting the Order of Display Items

You can reset the displayed order of numerical data to a preset order. For details on the reset information, see appendix 3, “List of Initial Settings and Display Order of Numerical Data.”

**Note**

- For the meanings of the measurement function symbols that are displayed, see section 1.2, “Measurement Functions and Measurement Periods,” 1.5, “Computation,” 1.6, “Integration,” appendix 1, “Symbols and Determination of Measurement Functions,” and appendix 2, “Determination of Delta Computation.”
- For details on the wiring units expressed as  $\Sigma A$ ,  $\Sigma B$ , and  $\Sigma C$ , see section 5.1, “Selecting the Wiring System.”
- [-----] (no data) is displayed in places where the measurement function is not selected or where numerical data is not present.

## 6.2 Setting the Measurement Period

«For a functional description, see section 1.2.»

### Keys

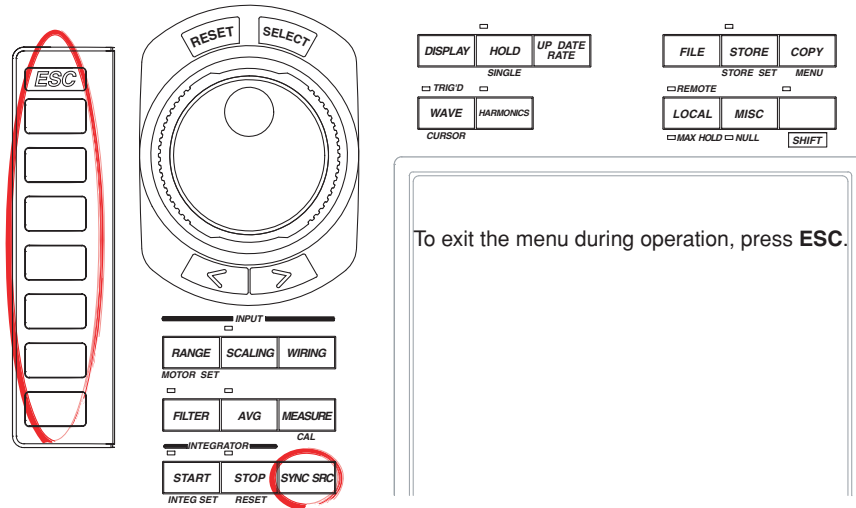

### Procedure

1. Press **SYNC SRC** to display the Sync Src menu.

#### Selecting the Target Element

2. Press the **Element Object** soft key to display the Element menu.  
Only the installed elements are displayed.
3. Press one of the soft keys corresponding to the displayed element to select the target element. The selected element is displayed at the upper right corner of the screen (if you selected element 1, Sync Src1 are displayed).

#### Setting the Synchronization Source

4. Press the **Item Up Exec** or **Item Down Exec** soft key to set the synchronization source. The specified synchronization source is displayed by the element displayed at the upper right corner of the screen.

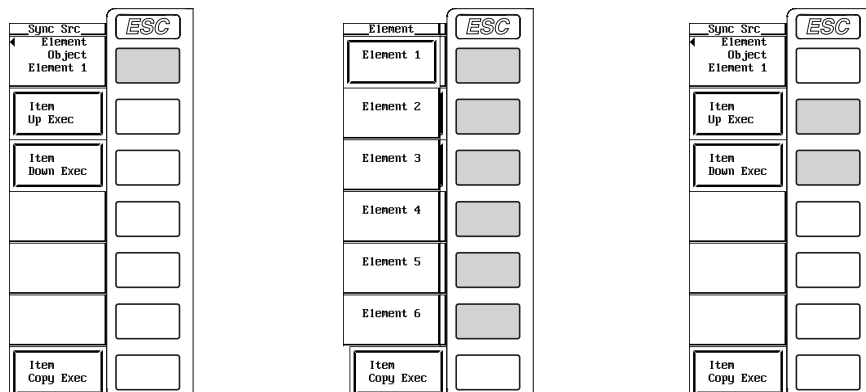

### Copying the Synchronization Source

The synchronization source specified for a given element can be set to the elements of the same wiring unit. The synchronization source for other elements that were specified before is not held.

- Press one of the soft keys corresponding to the displayed element from which the information is to be copied (the copy source).
- Press the **Item Copy Exec** soft key. The synchronization source of the copy source is copied to the elements of the same wiring unit. However, if the wiring system is pattern 1, the measurement range is copied to all other elements.

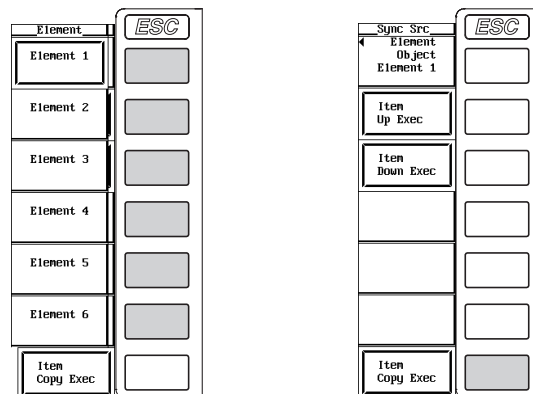

#### Explanation

During normal measurement, the numerical data is measured or computed using the sampled data in the measurement period that is determined according to the following principle.

### Display Position of the Target Element and Synchronization Source

Displayed at the upper right corner of the screen when SYNC SRC is pressed.

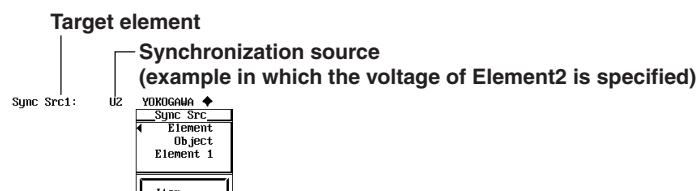

### Selecting the Target Element to Be Specified

Only the installed elements are displayed. The Element menu is displayed according to the element configuration of the product.

### Setting the Synchronization Source

You can select which input signal will be the synchronization source (synchronized to the zero-crossing point of the input signal) for each element. Select the signal to be the synchronization source from the following list of choices. The selectable items vary depending on the installed elements.

U1, I1, U2, I2, U3, I3, U4, I4, U5, I5, U6, I6, Ext Clk (external clock)\*, and None

\* For the specifications of the Ext Clk (external clock), see the explanation in section 7.4.

### Note

- If you specify no synchronization source by selecting "None," the entire sampled data within the data update interval is the data used to determine the numerical data. When measuring DC signals, this method can be used to prevent errors in the detection of the measurement period caused by noise.
- It is recommended that the synchronization source be set so that the number of periods of the input signal is as many as possible by setting the measurement period long. This is to improve the measurement accuracy.

## 6.2 Setting the Measurement Period

### Measurement Period

- The measurement period is set between the first point where the synchronization source crosses the level zero point (center of the amplitude) on the rising slope (or falling slope) within the data update interval and the last point where the synchronization source crosses the level zero point (center of the amplitude) on the rising slope (or falling slope) within the update interval.
- The rising or falling edge is automatically selected for the one that allows the interval to be longer.
- If the number of rising slope or falling slope within the data update interval is zero or one, the measurement period is set to the entire span within the data update interval.

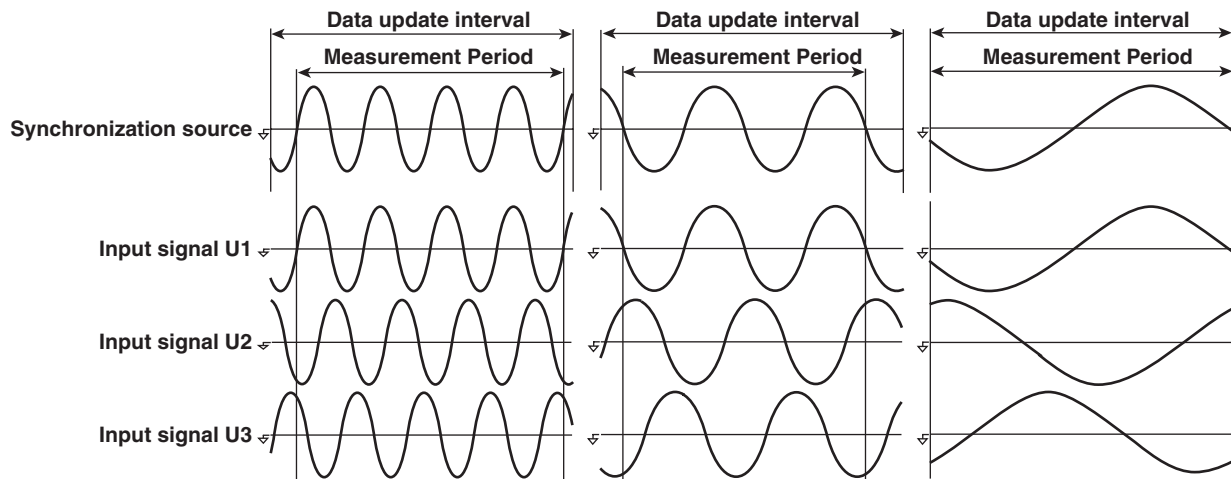

### Note

- The measurement period for the numerical data of the maximum value (Peak) for voltage and current is the entire span within the data update interval regardless of the settings above. Therefore, the measurement period for the measurement functions  $U_{+pk}$ ,  $U_{-pk}$ ,  $I_{+pk}$ ,  $I_{-pk}$ ,  $CfU$ ,  $CfI$ ,  $FfU$ , and  $FfI$  that are determined from the maximum value of the voltage and current is also the entire span within the data update interval.
- The measurement period during harmonic measurement is as follows:  
The number of sampled data to be used in harmonic measurement is set to 8192, 4096, or 2048 points (see section 7.7). The range corresponding to the selected number of sampled data is the measurement period. When the waveform is displayed, the measurement period corresponds to one screen of the waveform.

### Copying the Synchronization Source

The synchronization source specified for a given element can be set to the elements of the same wiring unit. However, if the wiring system is pattern 1, the measurement range can be copied to all other elements. The synchronization source for other elements that were specified before is not held.

## 6.3 Selecting the Frequency Measurement Target

### Keys

«For a functional description, see section 1.2.»

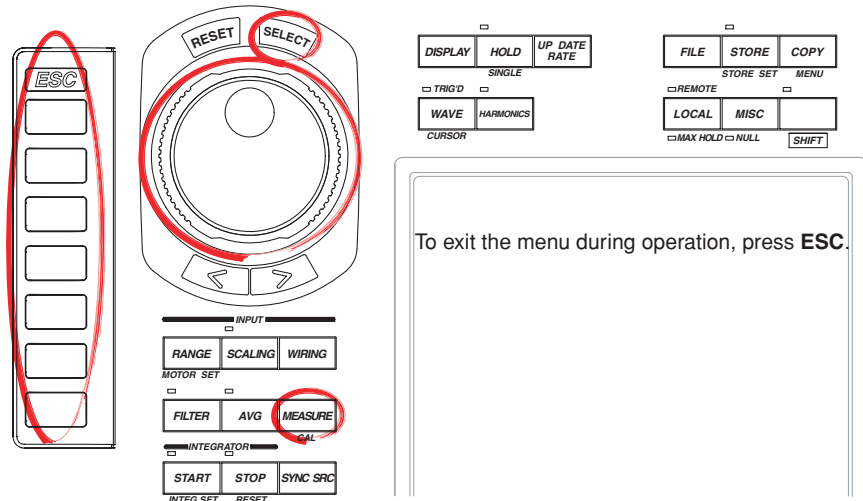

To exit the menu during operation, press **ESC**.

### Procedure

1. Press **MEASURE** to display the Measure menu.
2. Press the **Freq Item** soft key to display the Freq Item dialog box.  
Only the input signal of installed elements are displayed.
3. Turn the **jog shuttle** to select the signal for which the frequency is to be measured.
4. Press **SELECT**. The frequency of the input signal to be measured is indicated by the highlighting of the button that is located to the left of the selected input signal. If the highlighting is released, the frequency of that input signal will not be measured.

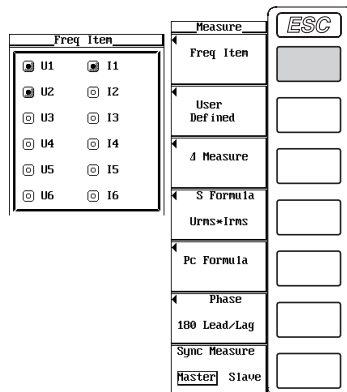

### Explanation

Up to three input signals from the installed elements can be selected as targets for frequency measurements. If three input signals are already selected and you wish to select another input signal, release one of the selected input signal first.

### Note

Even if the harmonic measurement mode is turned ON (see section 7.1), the Freq Item menu above is displayed and you can select the frequency measurement target. The frequency measurement target is common to normal measurement and harmonic measurement. For the relation between the frequency measurement target and the PLL source of harmonic measurement, see section 7.4.



## 6.4 Setting the User-Defined Function

«For a functional description, see section 1.5.»

### Keys

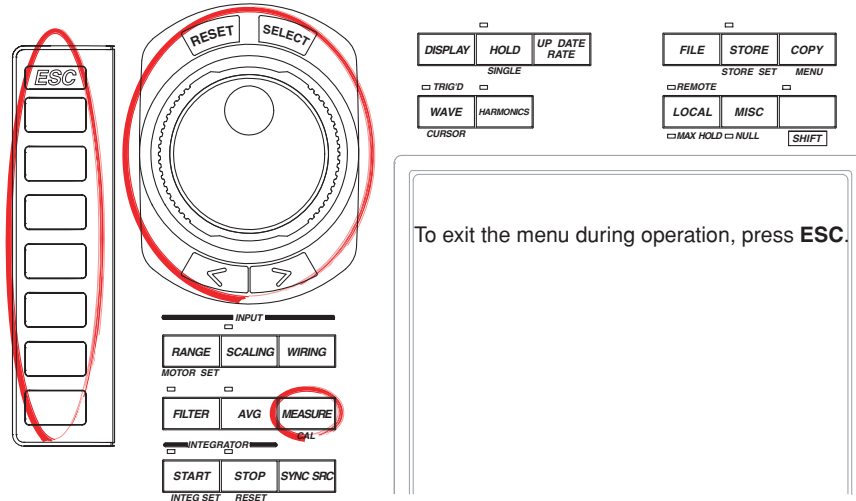

To exit the menu during operation, press **ESC**.

### Procedure

Check that the measurement mode is set to normal measurement. If the measurement mode is set to harmonic measurement, set Mode to OFF in the Harmonics menu (see section 7.1).

1. Press **MEASURE** to display the Measure menu.
2. Press the **User Defined** soft key to display the User Defined Function dialog box.

#### Turning ON/OFF the User-Defined Function Computation

3. Turn the **jog shuttle** to select the user-defined function you wish to enter from Function1 to Function4.
4. Press **SELECT** to select ON or OFF.

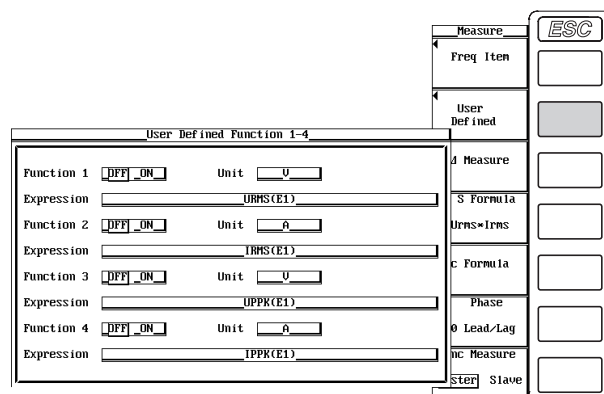

**Setting the Unit**

5. Turn the **jog shuttle** to select Unit.
6. Press **SELECT** to display the keyboard.
7. Use the **keyboard** to set the unit.

For keyboard operations, see section 3.12, "Entering Values and Strings."

**Setting the Equation**

8. Turn the **jog shuttle** to select Expression.
9. Press **SELECT** to display the keyboard.
10. Use the **keyboard** to set the equation.

For keyboard operations, see section 3.12, "Entering Values and Strings."

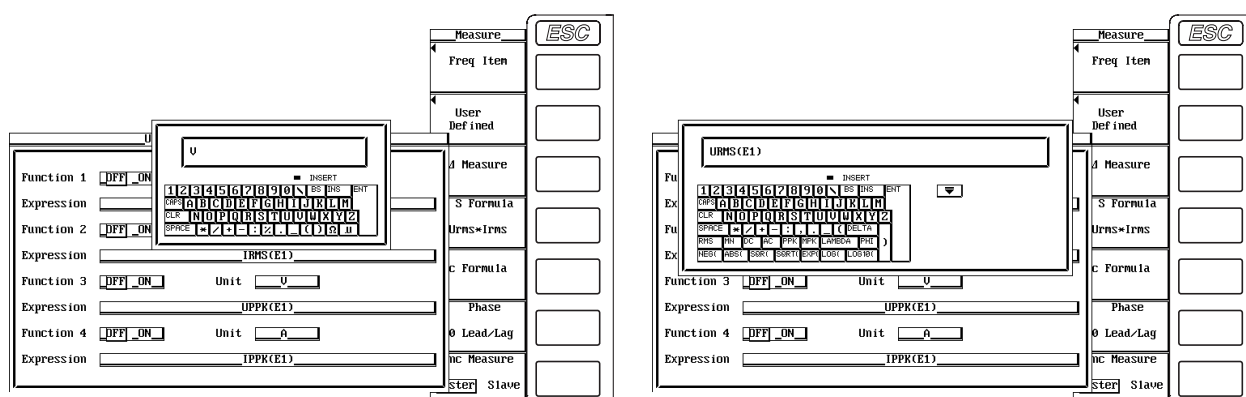
**Explanation**

An equation can be created by combining the measurement function symbols. Using the numerical values of the measurement functions, the numerical data of the new equation can be determined.

**Turning ON/OFF the User-Defined Function**

You can select whether to perform the specified user-defined function computation.

- ON  
Performs the computation.
- OFF  
Does not perform the computation.

**Setting the Unit**

- Number of characters  
Eight characters or less. However, not all eight characters can be shown on the numerical data display. This depends on the number of displayed items (see section 4.1).
- Types of characters  
Characters that are displayed on the keyboard or a space.

**Setting the Equation**

The combination of the measurement function and element number (Urms1, for example) can be used as an operand to create up to four equations (F1 to F4). There can be up to 16 operands in one equation.

• **Measurement functions for computation**

The operands for the measurement functions are shown below in the form

**measurement function: operand.**

Urms: URMS( )	Umn: UMN( )	Udc: UDC( )
Uac: UAC( )	Irms: IRMS( )	Imn: IMN( )
Idc: IDC( )	Iac: IAC( )	P: P( )
S: S( )	Q: Q( )	λ: LAMBDA( )
φ: PHI( )	fU: FU( )	fl: FI( )
U+pk: UPPK( )	U-pk: UMPK( )	I+pk: IPPK( )
I-pk: IMPK( )	CfU: CFU( )	Cfl: CFI( )
FfU: FFU( )	Ffl: FFI( )	Z: Z( )
Rs: RS( )	Xs: XS( )	Rp: RP( )
Xp: XP( )	Pc: PC( )	η: ETA( )
1/η: DIVETA( )	ΔUrms: DELTAURM( )	ΔUmn: DELTAUMN( )
ΔUdc: DELTAUDC( )	ΔUac: DELTAUAC( )	ΔIrms: DELTAIRM( )
ΔImn: DELTAIMN( )	ΔIdc: DELTAIDC( )	ΔIac: DELTAIAC( )
Pm: PM( )	Torque: TORQUE( )	Speed: SPEED( )
Slip: SLIP( )	Sync: SYNC( )	ηmA: MAETA( )
ηmB: MBETA( )	Wp: WH( )	Wp+: WHP( )
Wp-: WHM( )	q: AH( )	q+: AHP( )
q-: AHM( )	Time: TI( )	

- A symbol representing the element to which the measured signal is to be applied is entered in parentheses ( ). Elements 1, 2, 3, 4, 5, 6, ΣA, ΣB, and ΣC are represented by the symbols E1, E2, E3, E4, E5, E6, E7, E8, and E9 respectively. One symbol from E1 to E9 can be used, except for the following computation symbols.
  - One symbol from E1 to E6 can be entered in the parentheses for FU( ) to FFI( ) functions.
  - No symbols need to be entered in the parentheses for ETA( ), DIVETA( ), PM( ), TORQUE( ), SPEED( ), SLIP( ), SYNC( ), MAETA( ), and MBETA( ).
  - The element symbol inside the parentheses of delta computation (DELTAURM( ) to DELTAIAC( )) does not represent the element to which the measured signal is to be applied, but rather the location (Δ1 to Δ4) at which to store or display the results of the delta computation (see section 6.5). Δ1, Δ2, Δ3, and Δ4 are represented by symbols E1, E2, E3, and E4, respectively. One symbol from E1 to E4 can be set within the range defined by the delta computation. For example, DELTAURM(E1) substitutes the value of ΔUrms1 in the equation.
- The measurement functions η (efficiency 1) and 1/η (efficiency 2) are displayed as percentages as indicated by the equations given in appendix 1, “Symbols and Determination of Measurement Functions.” However, measurement functions ETA and DIVETA described in this section are displayed as ratios.
 

Example η: 80%, ETA = 0.8
- The user-defined function lets you can combine operands to calculate physical values other than those offered by the standard measurement functions. For example, the equation for measurement function S calculates efficiency using PSB in the numerator and PSA in the denominator. With user-defined functions, you can calculate efficiency using different values in the numerator and denominator, such as values from a separate power measurement.

- **Operators**

The following operators can be used to create the equation.

Operator	Example	Description
+, -, *, /	URMS(E1)+URMS(E2)	Basic arithmetic of the measurement functions
ABS	ABS(UMN(E1)-UMN(E2))	Absolute value of the measurement function
SQR	SQR(IDC(E1))	Square of the measurement function
SQRT	SQRT(ABS(IDC(E1)))	Square root of the measurement function
LOG	LOG(UDC(E1))	Natural log of the measurement function
LOG10	LOG10(UDC(E1))	Common log of the measurement function
EXP	EXP(UAC(E1))	Exponent of the measurement function
NEG	NEG(URMS(E1))	Negation of the measurement function

- **Number and Type of Characters That Can Be Used in the Equation**

- Number of characters  
50 characters or less.
- Types of characters  
Characters that are displayed on the keyboard or a space.

**Note**

- An equation (F1 to F4) cannot be placed inside another equation (F1 to F4).
- If an operand in the equation is undetermined, the computation result displays [-----] (no data). For example, if a measurement function of a delta computation is in the equation, but the delta computation is turned OFF or a measurement function of an element that is installed is in the equation, an error message is displayed.

## 6.5 Setting the Delta Computation

«For a functional description, see section 1.5.»

### Keys

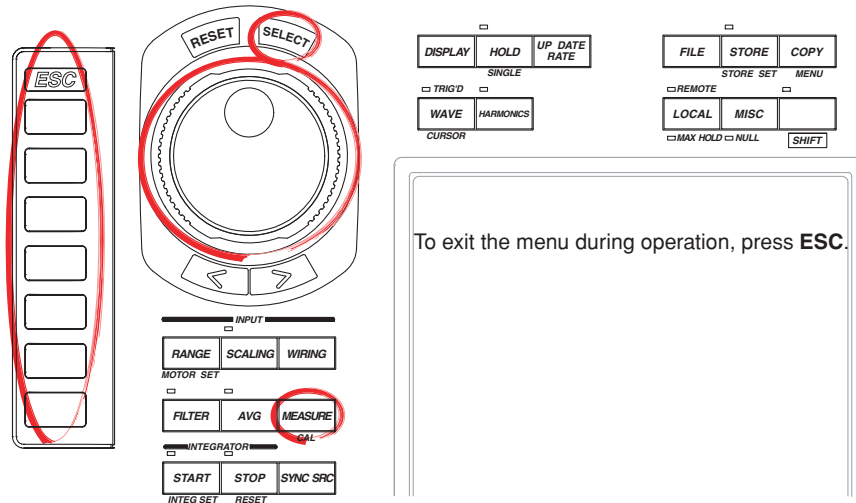

### Procedure

Check that the measurement mode is set to normal measurement. If the measurement mode is set to harmonic measurement, set Mode to OFF in the Harmonics menu (see section 7.1).

1. Press **MEASURE** to display the Measure menu.
2. Press the  $\Delta$ Measure soft key to display the  $\Delta$ Measure dialog box.

#### Selecting the Target Wiring Unit for the Delta Computation

3. Turn the **jog shuttle** to select Object.
4. Press **SELECT**. The wiring unit selection box appears.
5. Turn the **jog shuttle** to select the wiring unit.
6. Press **SELECT** to confirm.

#### Selecting the Delta Computation Type

(The menu varies depending on the wiring system.)

7. Turn the **jog shuttle** to select Type.
8. Press **SELECT** to display the type selection box.
9. Turn the **jog shuttle** to select the delta computation type.
10. Press **SELECT** to confirm.

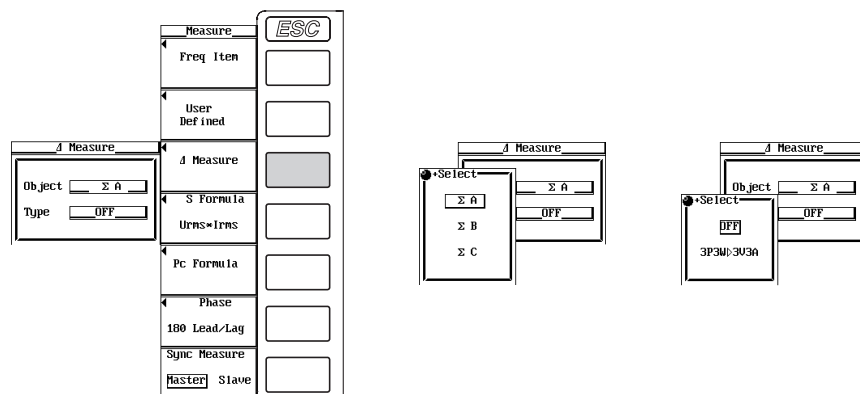

**Explanation**

In the normal measurement mode, the sum or difference of the instantaneous values (sampled data) of the voltage or current between the elements assigned to the target wiring unit for the delta computation can be used to determine the measurement functions,  $\Delta U$  ( $\Delta U_{rms}$ ,  $\Delta U_{mn}$ ,  $\Delta U_{dc}$ ,  $\Delta U_{ac}$ ),  $\Delta I$  ( $\Delta I_{rms}$ ,  $\Delta I_{mn}$ ,  $\Delta I_{dc}$ ,  $\Delta I_{ac}$ ). This operation is called delta computation. For the equation, see appendix 2. The measurement periods are the same as those described in section 1.2, "Measurement Functions and Measurement Periods."

**Selecting the Target Wiring Unit for the Delta Computation**

You can select the target wiring unit for the delta computation from the following list of choices. The selectable items vary depending on the selected wiring system pattern.

$\Sigma A$ ,  $\Sigma B$ ,  $\Sigma C$

**Selecting the Delta Computation Type**

You can select the delta computation type from the following list of choices. The selectable items vary depending on the selected wiring system pattern.

- **3P3W>3V3A**

Computes the other data when the wiring system is changed from three-phase, three-wire (3P3W) to three-voltage, three-current (3V3A).

$\Delta U1$  ( $\Delta U_{rms1}$ ,  $\Delta U_{mn1}$ ,  $\Delta U_{dc1}$ ,  $\Delta U_{ac1}$ )

$\Delta I1$  ( $\Delta I_{rms1}$ ,  $\Delta I_{mn1}$ ,  $\Delta I_{dc1}$ ,  $\Delta I_{ac1}$ )

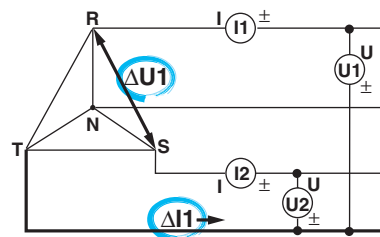

- **Delta>Star**

Using the data from a three-voltage, three-current system, the various data of a star connection is computed from the data of a delta connection (delta-star transformation).

$\Delta U1$  ( $\Delta U_{rms1}$ ,  $\Delta U_{mn1}$ ,  $\Delta U_{dc1}$ ,  $\Delta U_{ac1}$ )

$\Delta U2$  ( $\Delta U_{rms2}$ ,  $\Delta U_{mn2}$ ,  $\Delta U_{dc2}$ ,  $\Delta U_{ac2}$ )

$\Delta U3$  ( $\Delta U_{rms3}$ ,  $\Delta U_{mn3}$ ,  $\Delta U_{dc3}$ ,  $\Delta U_{ac3}$ )

$\Delta I4$  ( $\Delta I_{rms4}$ ,  $\Delta I_{mn4}$ ,  $\Delta I_{dc4}$ ,  $\Delta I_{ac4}$ )

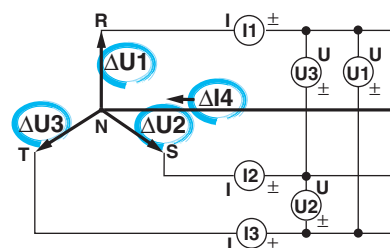

## 6.5 Setting the Delta Computation

---

- **Star>Delta**

Using the data from a three-phase, four-wire system, the various data of a delta connection are computed from the data of a star connection (star-delta transformation).

$\Delta U1$  ( $\Delta U_{rms1}$ ,  $\Delta U_{mn1}$ ,  $\Delta U_{dc1}$ ,  $\Delta U_{ac1}$ )

$\Delta U2$  ( $\Delta U_{rms2}$ ,  $\Delta U_{mn2}$ ,  $\Delta U_{dc2}$ ,  $\Delta U_{ac2}$ )

$\Delta U3$  ( $\Delta U_{rms3}$ ,  $\Delta U_{mn3}$ ,  $\Delta U_{dc3}$ ,  $\Delta U_{ac3}$ )

$\Delta I4$  ( $\Delta I_{rms4}$ ,  $\Delta I_{mn4}$ ,  $\Delta I_{dc4}$ ,  $\Delta I_{ac4}$ )

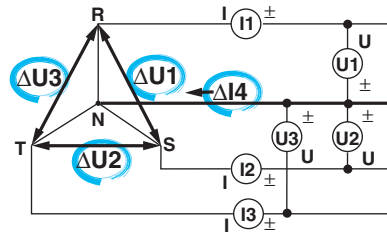

---

### Note

- If the sampled data used in the computation do not exist (for example, when the element is not installed), the sampled data are considered to be 0's for the computation.
  - It is recommended that the measurement range and scaling (PT/CT ratio and coefficients) of the elements that are being computed (delta computation) be set the same as much as possible. Using a different measurement range or scaling causes the measurement resolution of the sampled data to be different. In effect, the computation result will have errors.
  - The number (1, 2, 3, and 4) that is attached to the measurement function symbol of the delta computation has no relation to the element number. For example, if the delta computation type is set to 3P3W>3V3A, the true RMS value is computed using the u1-u2 data. The resultant data is displayed as a  $\Delta U_{rms1}$  value.
  - This function does not operate on products with only a single element. In such case, the menu does not appear.
  - If the wiring system on which delta computation is to be performed is single-phase, two-wire (1P2W), delta computation cannot be performed.
-

## 6.6 Setting the Equations for Apparent Power and Corrected Power

«For a functional description, see section 1.5.»

### Keys

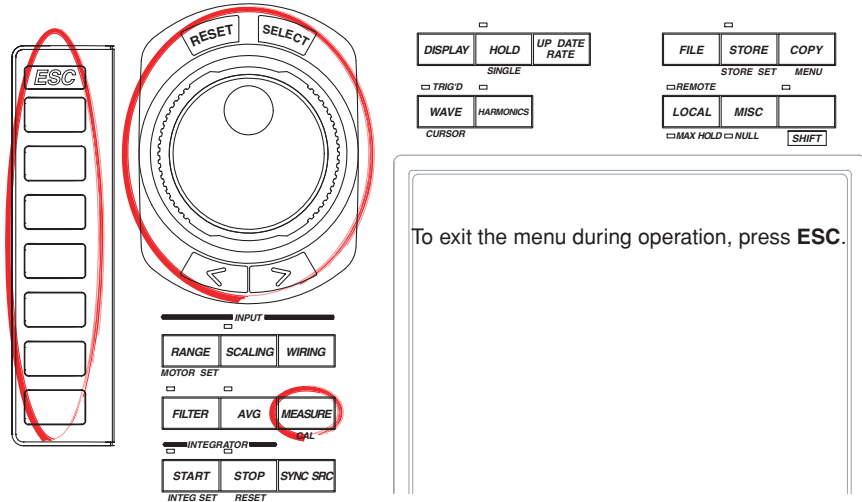

To exit the menu during operation, press ESC.

### Procedure

Check that the measurement mode is set to normal measurement. If the measurement mode is set to harmonic measurement, set Mode to OFF in the Harmonics menu (see section 7.1).

1. Press **MEASURE** to display the Measure menu.

#### Selecting the Equation for Apparent Power

2. Press the **S Formula** soft key to display the S Formula menu.
3. Press one of the soft keys from **Urms\*Irms** to **Umean\*Irms** to select the equation for apparent power.

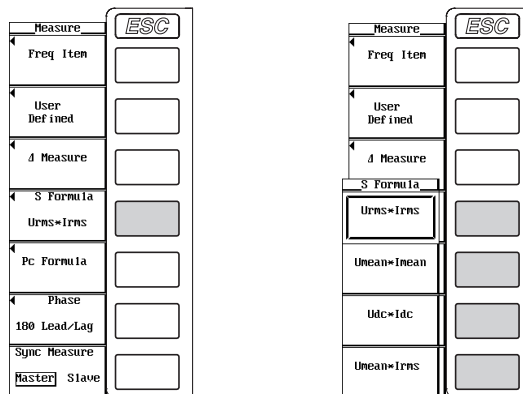



## 6.6 Setting the Equations for Apparent Power and Corrected Power

### Setting the Equation for Corrected Power

2. Press the **Pc Formula** soft key to display the Pc Formula dialog box.
  - **Selecting the applicable standard**
  - 3. Turn the **jog shuttle** to select the standard for Pc Formula.
  - 4. Press **SELECT** to select either IEC76-1(1976), IEEE C57.12.90-1993 or IEC76-1(1993).
- **Setting the coefficient**  
(When the applicable standard of the equation is IEC76-1(1976), IEEE C57.12.90-1993)
  5. Turn the **jog shuttle** to select P1=.
  6. Press **SELECT**. A box used to set coefficient P1 appears.
  7. Turn the **jog shuttle** to set P1.

For the procedures on how to enter values using the jog shuttle, see section 3.12, "Entering Values and Strings."
  8. Press **SELECT** or **ESC** to close the box.
  9. Turn the **jog shuttle** to select P2=.
  10. Press **SELECT**. A box used to set coefficient P2 appears.
  11. Turn the **jog shuttle** to set P2.

For the procedures on how to enter values using the jog shuttle, see section 3.12, "Entering Values and Strings."
  12. Press **SELECT** or **ESC** to close the box.

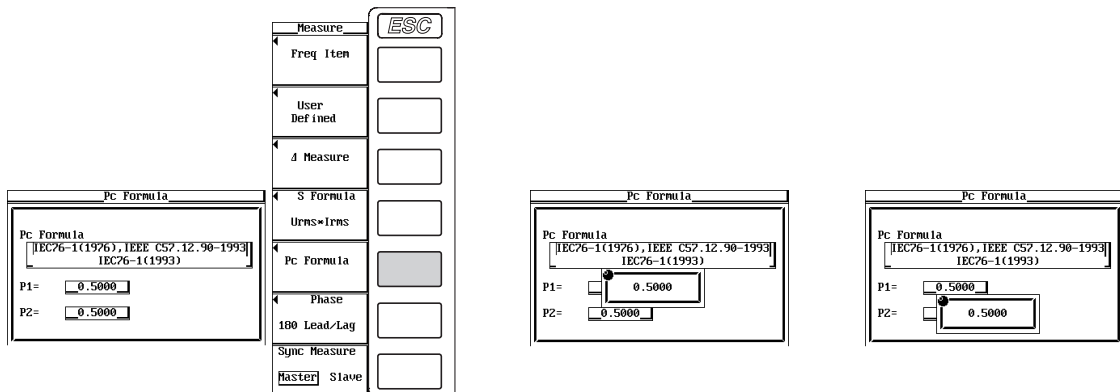

**Explanation****Selecting the Equation for Apparent Power**

The apparent power, in the normal measurement mode, can be determined by the product of the voltage ( $U_{rms}$ ,  $U_{mean}$ , and  $U_{dc}$ ) and current ( $I_{rms}$ ,  $I_{mean}$ , and  $I_{dc}$ ). There are three types of voltages and currents when measuring in the normal measurement mode. Select which voltage and current to use to determine the apparent power from the following list of choices.

- $U_{rms} * I_{rms}$   
Determines the apparent power from the true rms values of voltage and current.
- $U_{mean} * I_{mean}$   
Determines the apparent power from the rectified mean value calibrated to the rms value of the voltage and current.
- $U_{dc} * I_{dc}$   
Determines the apparent power from the simple average of the voltage and current.
- $U_{mean} * I_{rms}$   
Determines the apparent power from the rectified mean value calibrated to the rms value of the voltage and the true rms value of the current.

**Setting the Equation for Corrected Power**

Depending on the applicable standard, when the load that is connected to the potential transformer is extremely small, the active power of the potential transformer that is measured needs to be compensated. In such case, set the compensating equation and the coefficient. Corrected power ( $P_c$ ) is a measurement function in the normal measurement mode.

- **Selecting the applicable standard**  
Select the standard from the following choices. For the equations of each applicable standard, see section 1.5.
  - IEC76-1(1976), IEEE C57.12.90-1993
  - IEC76-1(1993)
- **Setting the coefficient**  
Set coefficients P1 and P2.  
Set the coefficients in the range from 0.0001 to 9.9999.

**Note**

The equations for apparent power and corrected power are applied to measurement functions in the normal measurement mode.

## 6.7 Selecting the Display Format of the Phase Difference

«For a functional description, see section 1.5.»

### Keys

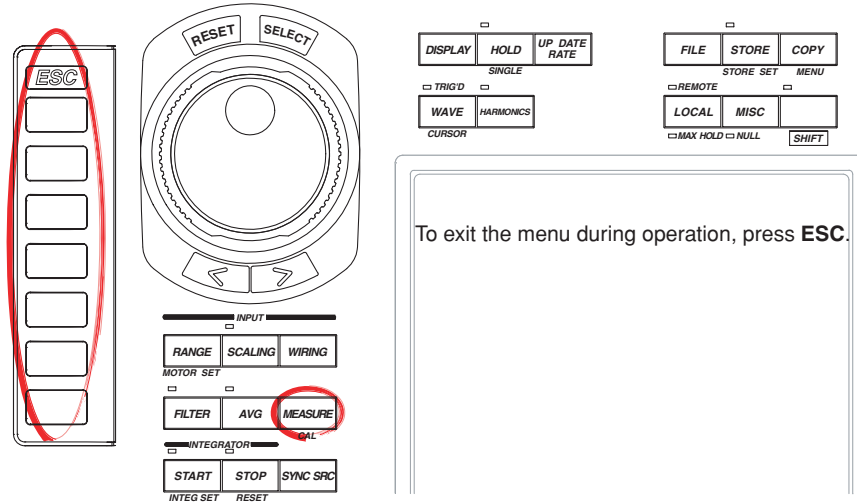

### Procedure

Check that the measurement mode is set to normal measurement. If the measurement mode is set to harmonic measurement, set Mode to OFF in the Harmonics menu (see section 7.1).

1. Press **MEASURE** to display the Measure menu.
2. Press the **Phase** soft key to display the Phase menu.
3. Press either the **180 Lead/Lag** or **360 degrees** soft key to select the display format of the phase difference.

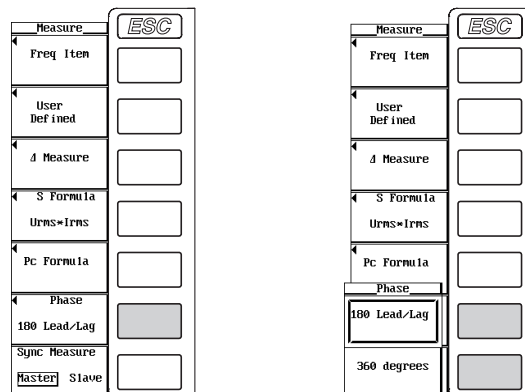

**Explanation**

Select the display format of the phase difference  $\phi$  of the voltage and current from the following list of choices. This is valid during the normal measurement mode.

- 180 Lead/Lag

With the positive vertical axis set to zero degrees, this format displays  $\phi$  using 180° notation with a lead (D) indicated by the counter-clock wise direction and a lag (G) by the clockwise direction.

- 360 degrees

With the positive vertical axis set to zero degrees, this format displays  $\phi$  using 360° in the clockwise direction.

**Note**

- The display format in the harmonic measurement mode is fixed regardless of the selection as follows.

Measurement function  $\phi( )$  is displayed using 360° notation in the clockwise direction.

Measurement functions  $\phi U( )$  and  $\phi I( )$  are displayed using 180° notation with respect to the fundamental signals U(1) and I(1). The counter-clockwise direction is negative and clockwise direction is positive.

- When the measured value of either the voltage or current is zero, an error is displayed.
- When both the voltage and current are sinusoids and the ratio of the voltage and current inputs do not differ greatly with respect to the measurement range, the phase difference  $\phi$  of lead and lag are detected and displayed correctly.
- When the computation result of power factor  $\lambda$  exceeds "1,"  $\phi$  is displayed as follows:
  - When the power factor  $\lambda$  is greater than 1 and less than equal to 2,  $\phi$  displays zero.
  - When the power factor  $\lambda$  is greater than 2,  $\phi$  displays an error.

## 6.8 Setting the Normal Integration Mode and the Integration Timer

«For a functional description, see section 1.6.»

### Keys

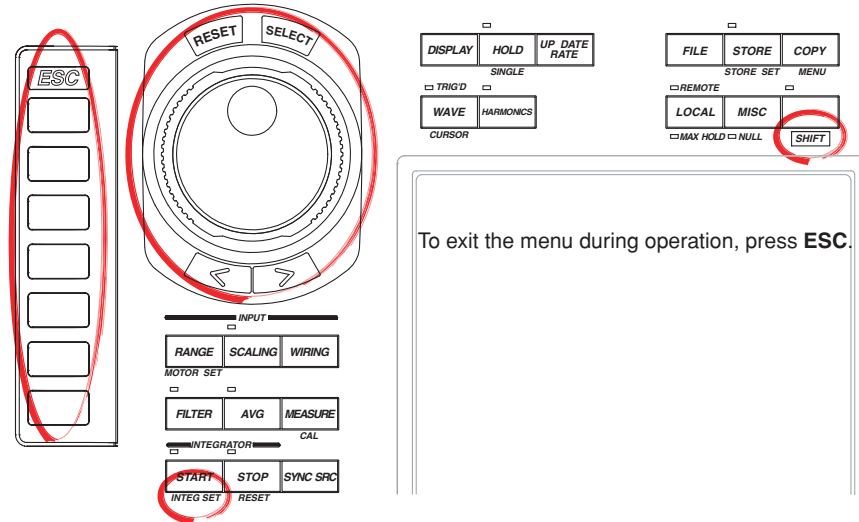

### Procedure

1. Press **SHIFT+START (INTEG SET)** to display the Integ Set menu.

#### Selecting Normal Integration Mode or Repetitive Integration Mode (Continuous)

2. Press the **Mode** soft key to display the Mode menu.
3. Press either the **Normal** or **Continuous** soft key to select the integration mode.

#### Selecting All Element Simultaneous Integration or Individual Element Integration

(This menu does not appear on products with only a single element. Proceed to step 5.)

4. Press the **Independent Control** soft key to select OFF or ON.  
If OFF is selected, integration is performed on all elements simultaneously. Proceed to step 5.  
If ON is selected, integration is performed according to the integration timer for each element. Proceed to step 11.

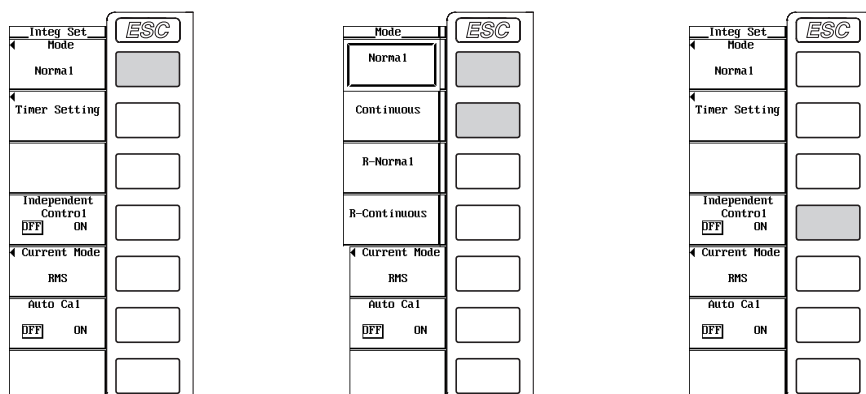

### Note

You can set the individual element integration through key operation, but the execution of integration can only be done through communication commands. Even if Independent Control is set to ON (individual element integration ON), the WT1600 operates in the same fashion as when Independent Control is OFF (individual element integration OFF).

### Setting the Integration Timer during All Element Simultaneous Computation (Independent Control OFF)

5. Press the **Timer Setting** soft key to display the Timer Setting dialog box.
6. Turn the **jog shuttle** to select one of the hour, minute, and second boxes.
7. Press **SELECT**. A box used to set the timer appears.
8. Turn the **jog shuttle** to set the hour, minute, or second that you selected in step 6.  
For the procedures on how to enter values using the jog shuttle, see section 3.12, "Entering Values and Strings."
9. Press **SELECT** or **ESC** to close the box.
10. Repeat steps 6 to 9 to set the hour, minute, and second. The procedure for setting the integration timer during all element simultaneous computation ends here.

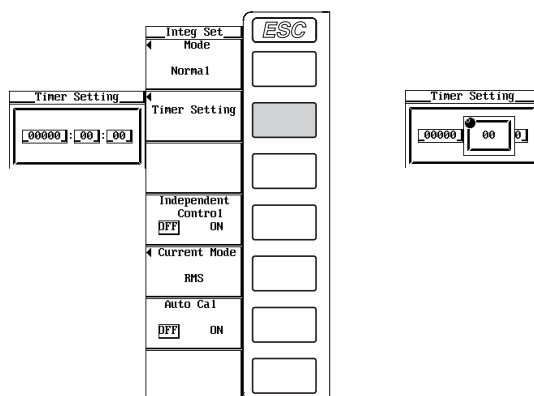

### Setting the Integration Timer during Individual Element Computation (Independent Control ON)

11. Press the **Timer Setting** soft key to display the Independent Timer Setting dialog box.
12. Turn the **jog shuttle** to select Setting.
13. Press **SELECT** to select Each or All.
14. Turn the **jog shuttle** to select one box from hour, minute, and second for Element 1.
15. Press **SELECT**. A box used to set the timer appears.
16. Turn the **jog shuttle** to set the hour, minute, or second that you selected in step 14.  
For the procedures on how to enter values using the jog shuttle, see section 3.12, "Entering Values and Strings."
17. Press **SELECT** or **ESC** to close the box.  
If you selected Each in step 13, the hour, minute, and second are set only to Element 1.  
If you selected All in step 13, the hour, minute, and second are set to all elements at once.
18. Repeat steps 14 to 17 to set hour, minute, and second.
19. If you selected Each in step 13, repeat steps 14 to 18 for all elements. The procedure for setting the integration timer during individual element computation ends here.

## 6.8 Setting the Normal Integration Mode and the Integration Timer

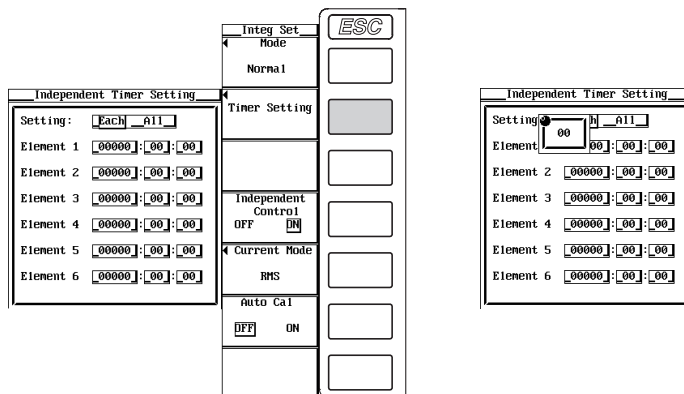

### Explanation

To perform integration, the integration mode and integration time must be set before starting the operation. This section will describe how to set the normal integration mode and the integration time. For the procedure in starting the integration, see section 6.11.

### Selecting the Normal Integration Mode or Repetitive Integration Mode

In this mode, the integration time is set in relative time and the integration is performed over the specified time. This mode consists of the following two types.

- Normal integration mode**  
 The integration time is set in relative time. The integration is stopped after the specified time elapses, when the maximum integration time of 10000 hours is exceeded, when you press STOP, or when the integration value reaches the maximum or minimum integration display value ( $\pm 999999$  MWh or  $\pm 999999$  MAh). The integration time and value are held at that point.
- Repetitive integration mode (continuous integration)**  
 The integration time is set in relative time. When the specified time elapses, the operation is automatically reset and restarted. Integration is repeated until Stop is pressed. When the integration value reaches the maximum or minimum integration display value. The integration time and value are held at that point.

### Setting the Integration Timer

- Set the time in units of hour:minute:second in the following range.  
0000:00:00 to 10000:00:00
- When performing all element simultaneous integration by turning Independent Control OFF, a single integration timer can be specified. The value specified here is also set in the integration timer of Element 1 in the Independent Timer Setting dialog box that appears when Independent Control is turned ON.
- When performing individual element integration by turning Independent Control ON, timers can be specified for each element. The value specified for the integration timer for Element 1 is also set in the integration timer in the Timer Setting dialog box that appears when Independent Control is turned OFF.
- By turning Independent Control ON, the integration timer can be set for each element (Each) or for all elements at once (All).

### Note

- If the integration timer is set to 0000:00:00 in the normal integration mode, the integration is performed in manual integration mode (see section 1.6 and 6.11).
- The individual element integration function does not operate on products with only a single element. In such case, the individual element integration menu does not appear.

## 6.9 Setting the Real-time Integration Mode, the Integration Timer, and the Reservation Time

«For a functional description, see section 1.6.»

### Keys

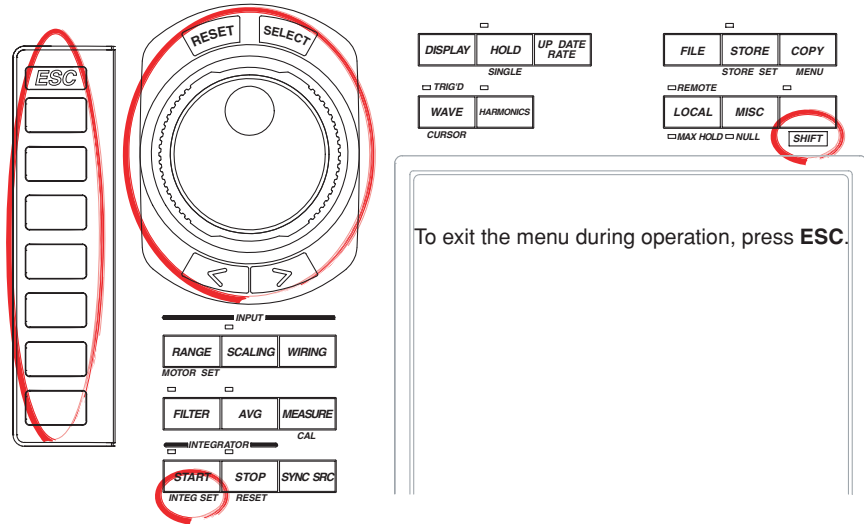

### Procedure

1. Press **SHIFT+START (INTEG SET)** to display the Integ Set menu.

#### Selecting Real-time Normal Integration Mode (R-Normal) or Real-time Repetitive Integration Mode (R-Continuous)

2. Press the **Mode** soft key to display the Mode menu.
3. Press either the **R-Normal** or **R-Continuous** soft key to select the integration mode.

#### Selecting All Element Simultaneous Integration or Individual Element Integration

(This menu does not appear on products with only a single element. Proceed to step 5.)

4. Press the **Independent Control** soft key to select OFF or ON.  
If OFF is selected, integration is performed on all elements at the same reservation time. Proceed to step 5.  
If ON is selected, integration is performed according to the reservation time and integration timer for each element. Proceed to step 19.

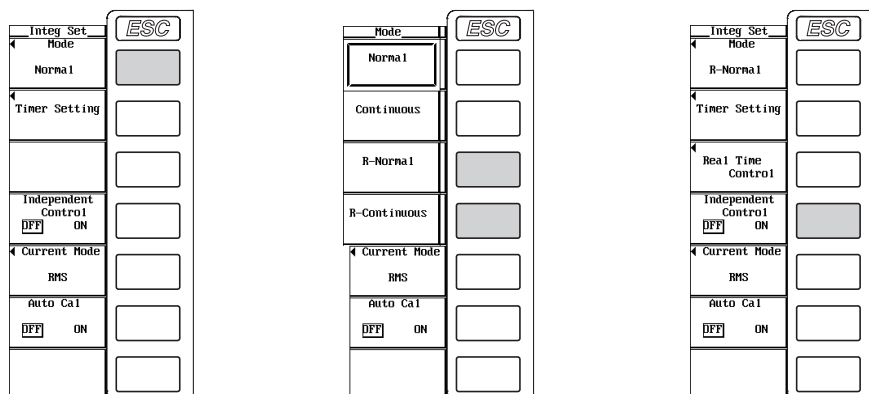

#### Note

You can set the individual element integration through key operation, but the execution of integration can only be done through communication commands. Even if Independent Control is set to ON (individual element integration ON), the WT1600 operates in the same fashion when Independent Control is OFF (individual element integration OFF).



**Setting the Integration Timer during All Element Simultaneous Computation (Independent Control OFF)**

5. Press the **Timer Setting** soft key to display the Timer Setting dialog box.
6. Turn the **jog shuttle** to select one box from hour, minute, and second.
7. Press **SELECT**. A box used to set the timer appears.
8. Turn the **jog shuttle** to set the hour, minute, or second that you selected in step 6.  
For the procedures on how to enter values using the jog shuttle, see section 3.12, "Entering Values and Strings."
9. Press **SELECT** or **ESC** to close the box.
10. Repeat steps 6 to 9 to set hour, minute, and second. The procedure for setting the integration timer during all element simultaneous computation ends here.

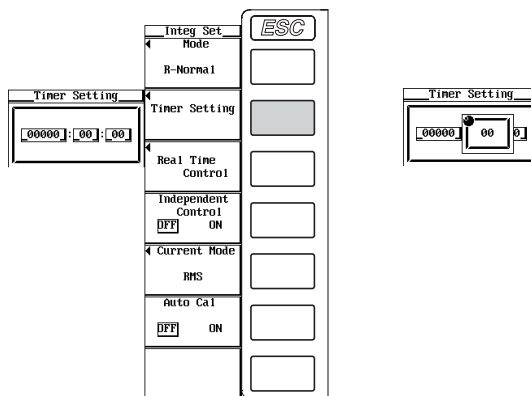

**Setting the Reservation Time during All Element Simultaneous Computation (Independent Control OFF)**

11. Press the **Real Time Control** soft key to display the Real Time Control dialog box.
12. Turn the **jog shuttle** to select one of the reservation year, month, date, hour, minute, and second boxes for specifying when the integration operation will start.
13. Press **SELECT**. A box used to set the timer appears.
14. Turn the **jog shuttle** to set the year, month, date, hour, minute, or second that you selected in step 12.  
For the procedures on how to enter values using the jog shuttle, see section 3.12, "Entering Values and Strings."
15. Press **SELECT** or **ESC** to close the box.
16. Repeat steps 12 to 15 to set the year, month, date, hour, minute, and second.
17. Turn the **jog shuttle** to select one of the reservation year, month, date, hour, minute, and second boxes for specifying when the integration operation will end.
18. Repeat steps 13 to 16 to set the year, month, date, hour, minute, and second. The procedure for setting the reservation time during all element simultaneous computation ends here.

## 6.9 Setting the Real-time Integration Mode, the Integration Timer, and the Reservation Time

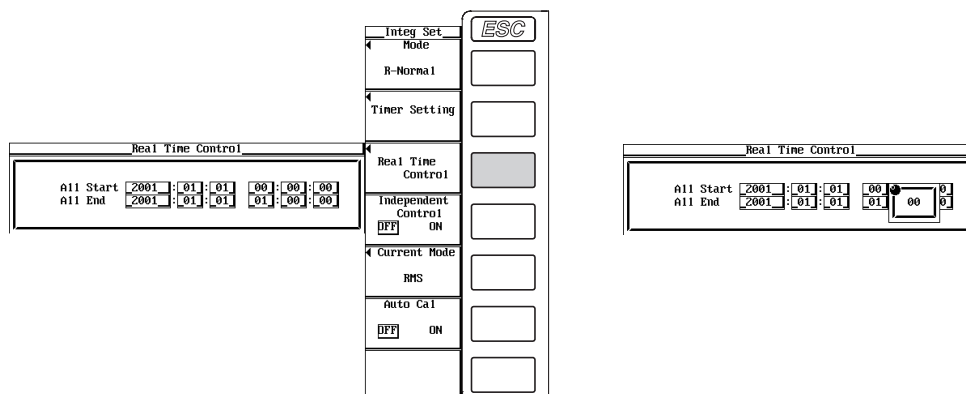

### Setting the Integration Timer during Individual Element Computation (Independent Control ON)

19. Press the **Timer Setting** soft key to display the Independent Timer Setting dialog box.
20. Turn the **jog shuttle** to select Setting.
21. Press **SELECT** to select Each or All.
22. Turn the **jog shuttle** to select one box from hour, minute, and second for Element1.
23. Press **SELECT**. A box used to set the timer appears.
24. Turn the **jog shuttle** to set the hour, minute, or second that you selected in step 22.
 

For the procedures on how to enter values using the jog shuttle, see section 3.12, "Entering Values and Strings."
25. Press **SELECT** or **ESC** to close the box.
 

If you selected Each in step 21, the hour, minute, and second are set only to Element 1.

If you selected All in step 21, the hour, minute, and second are set to all elements at once.
26. Repeat steps 22 to 25 to set hour, minute, and second.
27. If you selected Each in step 21, repeat steps 22 to 26 for all elements. The procedure for setting the integration timer during individual element computation ends here.

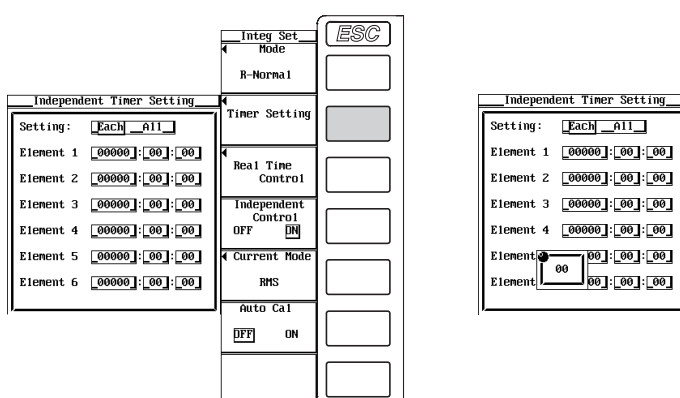

## 6.9 Setting the Real-time Integration Mode, the Integration Timer, and the Reservation Time

### Setting the Reservation Time during Individual Element Computation (Independent Control ON)

28. Press the **Real Time Control** soft key to display the Independent Real Time Control dialog box.
29. Turn the **jog shuttle** to select one of the reservation year, month, date, hour, minute, and second boxes for specifying when the integration operation will start.
30. Press **SELECT**. A box used to set the timer appears.
31. Turn the **jog shuttle** to set the year, month, date, hour, minute, or second that you selected in step 29.
  - For the procedures on how to enter values using the jog shuttle, see section 3.12, "Entering Values and Strings."
32. Press **SELECT** or **ESC** to close the box.
33. Repeat steps 29 to 32 to set the year, month, date, hour, minute, and second.
34. Turn the **jog shuttle** to select one of the reservation year, month, date, hour, minute, and second boxes for specifying when the integration operation will end.
35. Repeat steps 30 to 33 to set the year, month, date, hour, minute, and second. The procedure for setting the reservation time during individual element computation ends here.

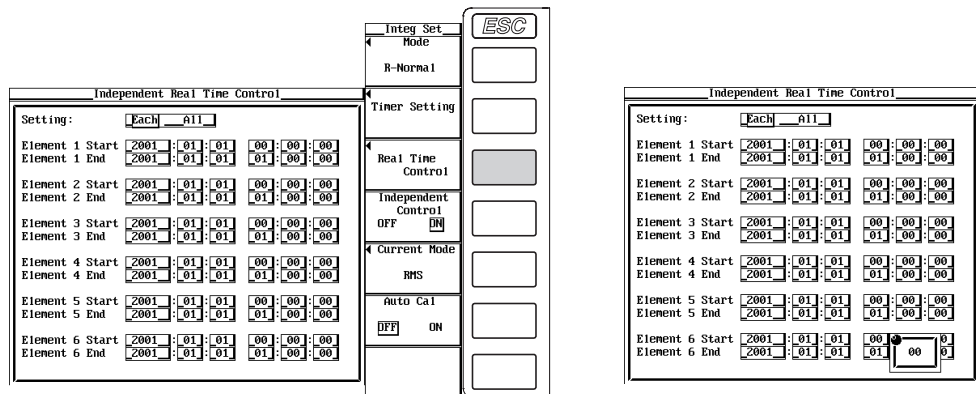

### Explanation

To perform integration, the integration mode and integration time must be set before starting the operation. This section will describe how to set the normal integration mode and the integration time for real-time control. For the procedure in starting the integration, see section 6.11.

### Selecting the Real-time Normal Integration Mode or Real-time Repetitive Integration Mode

In this mode, integration is performed between the times specified by integration start and stop. This mode consists of the following two types.

- **Real-time normal integration mode**  
The date and time of start and stop of the integration operation and the integration timer value are specified. The integration is stopped at the specified time, when the timer value is reached, when the maximum integration time of 10000 hours is exceeded, or when the integration value reaches the maximum or minimum integration display value ( $\pm 999999$  MWh or  $\pm 999999$  MAh). The integration time and value are held at that point.
- **Real-time repetitive integration mode (continuous integration)**  
The date and time of start and stop of the integration operation and the integration timer value are specified. The integration is repeated at the specified timer setting during that time. When the time specified by the timer elapses, the operation is automatically reset and restarted. The integration is stopped at the specified time or when the integration value reaches the maximum or minimum integration display value. The integration time and value are held at that point.

### Setting the Integration Timer

This description is the same as section 6.8.

- Set the time in units of hour:minute:second in the following range.  
0000:00:00 to 10000:00:00
- When performing all element simultaneous integration by turning Independent Control OFF, a single integration timer can be specified. The value specified here is also set in the integration timer of Element 1 in the Independent Timer Setting dialog box that appears when Independent Control is turned ON.
- When performing individual element integration by turning Independent Control ON, timers can be specified for each element. The value specified for the integration timer for Element 1 is also set in the integration timer in the Timer Setting dialog box that appears when Independent Control is turned OFF.
- By turning Independent Control ON, the integration timer can be set for each element (Each) or for all elements at once (All).

### Note

- If the integration timer is set to 0000:00:00 in the real-time normal integration mode, the integration is started at the specified start date/time. The integration is stopped at the specified stop date/time, when the maximum integration time of 10000 hours is exceeded, or when the integration value reaches the maximum or minimum integration display value. The integration time and value are held at that point.
  - The individual element integration function does not operate on products with only a single element. In such case, the individual element integration menu does not appear.
-

## 6.9 Setting the Real-time Integration Mode, the Integration Timer, and the Reservation Time

---

### Setting the Reservation Time

- The reservation time is set in units of year:month:date, hour:minute:second. Set the hour:minute:second in the following range.  
00:00:00 to 23:59:59
- When performing all element simultaneous integration by turning Independent Control OFF, a single reservation time can be specified. The value specified here is also set in the reservation time of Element 1 in the Independent Real Time Control dialog box that appears when Independent Control is turned ON.
- When performing individual element integration by turning Independent Control ON, the reservation time can be specified for each element. The value specified here for Element 1 is also set in the reservation time in the Real Time Control dialog box that appears when Independent Control is turned OFF.
- By turning Independent Control ON, the reservation time can be set for each element (Each) or for all elements at once (All).
- Make sure the reservation time for stopping the integration is after the reservation time for starting the integration.

### Note

---

- The reservation time allows up to 31 days to be specified for February. If an erroneous date is specified, an error message is displayed at the time of execution of the integration operation (section 6.11). Reset the reservation time in this case.
  - Leap years are recognized at the time of execution of the integration operation.
-

## 6.10 Selecting the Current Mode for Current Integration and ON/OFF of Integration Auto Calibration

«For a functional description, see section 1.6.»

### Keys

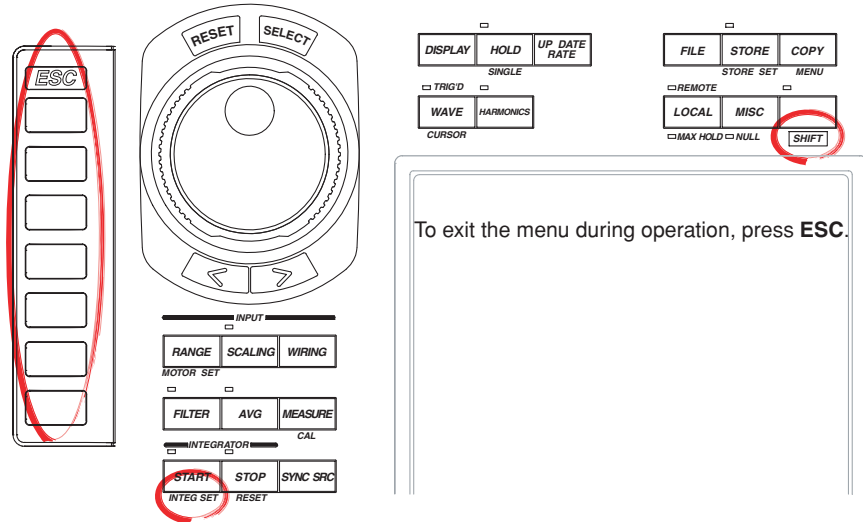

### Procedure

1. Press **SHIFT+START (INTEG SET)** to display the Integ Set menu.

#### Selecting the Current Mode for Current Integration

2. Press the **Current Mode** soft key to display the Current Mode dialog box.
3. Turn the **jog shuttle** to select Setting.
4. Press **SELECT** to select Each or All.
5. Turn the **jog shuttle** to select Element1.
6. Press **SELECT** to select one of the RMS to AC soft keys.  
If you selected Each in step 4, the current mode of only Element 1 is selected.  
If you selected All in step 4, the current mode of all elements is selected at once.
7. If you selected Each in step 4, repeat steps 5 and 6 for all elements.

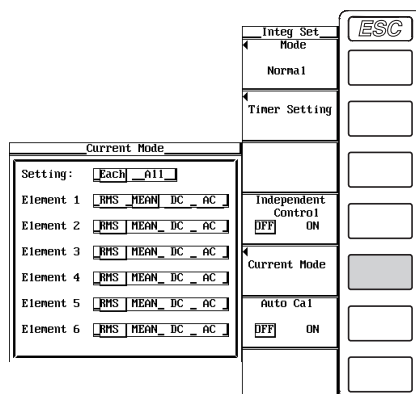

### Turning ON/OFF the Integration Auto Calibration

8. Press the **Auto Cal** soft key to select ON or OFF.

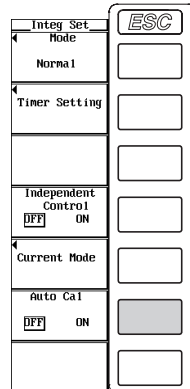

### Explanation

#### Selecting the Current Mode for Current Integration

- Select the current type used for current integration on each element from the following list of choices. For the equations of each current type, see section 1.2.
  - RMS: True rms value
  - MEAN: Rectified mean value calibrated to the rms value
  - DC: Linear averaging
  - AC: AC component
- When the current mode is set to DC, the polarity (+/-) is displayed.

#### Turning ON/OFF Integration Auto Calibration

Zero-level compensation is normally performed when the measurement range or line filter is changed. However, zero-level compensation can be automatically performed during integration.

- ON: Zero-level compensation is automatically performed approximately every hour while integration is in progress.
- OFF: Zero-level compensation is not automatically performed while integration is in progress.

#### Note

---

When zero-level compensation is in progress when integration auto calibration is turned ON, the power and current values that were measured immediately before are integrated.

---

## 6.11 Performing Integration (Start, Stop, and Reset)

«For a functional description, see section 1.6.»

### Keys

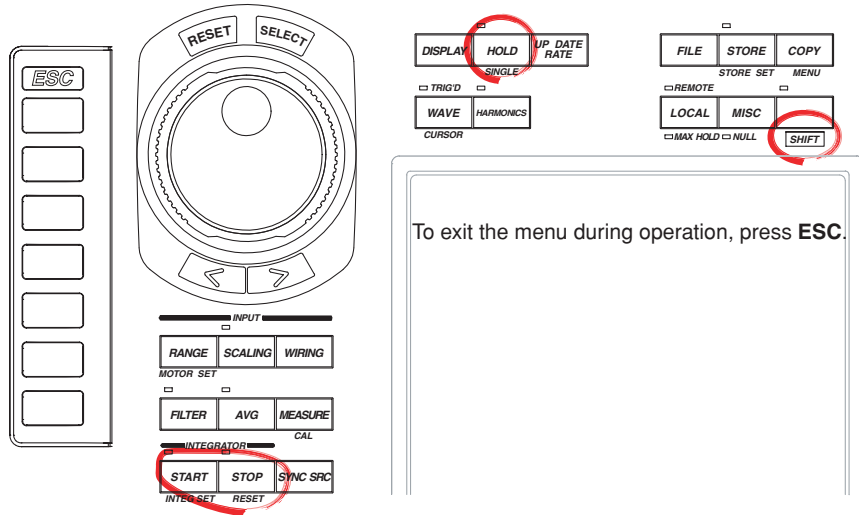

### Procedure

Check that the measurement mode is set to normal measurement. If the measurement mode is set to harmonic measurement, set Mode to OFF in the Harmonics menu (see section 7.1). Also, check that the retrieval of waveform display data (see section 9.1) is turned OFF.

#### Performing Integration in the Manual Integration Mode

1. Check that the integration mode is set to normal integration. See section 6.8.
  2. Check that the integration timer is set to 0000 : 00 : 00. See section 6.8.
- **Starting the integration**
  - 3. Press **START**. The START indicator above and to the left of the key illuminates and the integration is started.
  - **Holding the integration**
  - 4. Press **HOLD**. The HOLD indicator illuminates, and the numerical data display is held. Integration continues.
  - **Releasing the Held Condition**
  - 5. Press **HOLD** while the values are held. The HOLD indicator turns OFF, and the numerical data display is updated. In the held condition, the display can be updated by carrying out single measurements (by pressing SHIFT + HOLD (SINGLE)).
  - **Stopping the integration**
  - 6. Press **STOP**. The START indicator turns OFF and the STOP indicator illuminates. The integration time and integration value are held. Integration continues if you press **START** at this point.
  - **Resetting the Integration**
  - 7. Press **SHIFT+STOP (RESET)**. The STOP indicator turns OFF, the integration time and integration value are reset, and the display shows [-----] (no data).



## 6.11 Performing Integration (Start, Stop, and Reset)

### Performing Integration in the Normal Integration Mode

1. Check that the integration mode is set to normal integration or repetitive integration (Continuous). See section 6.8.
2. Check that the integration timer is set to some value other than 0000:00:00. See section 6.8.

- **Starting the integration**

3. Press **START**. The START indicator above and to the left of the key illuminates and the integration is started.

- **Holding the integration**

4. Press **HOLD**. The HOLD indicator illuminates, and the numerical data display is held. Integration continues.

- **Releasing the Held Condition**

5. Press **HOLD** while the values are held. The HOLD indicator turns OFF, and the numerical data display is updated. In the held condition, the display can be updated by carrying out single measurements (by pressing SHIFT + HOLD (SINGLE)).

- **Stopping the integration**

6. Press **STOP**. The START indicator turns OFF and the STOP indicator illuminates. The integration time and integration value are held. If you press STOP before the time specified by the integration timer is reached and then press START, integration continues up to the time specified by the integration timer.

If the time specified by the integration timer elapses in the normal integration mode, the START indicator turns OFF and the STOP indicator illuminates. The integration time and integration value are held.

If the time specified by the integration timer elapses in the repetitive integration mode, the integration time and integration value are automatically reset, and the integration is repeated until Stop is pressed.

- **Resetting the integration**

7. Press **SHIFT+STOP (RESET)**. The STOP indicator turns OFF, the integration time and integration value are reset, and the display shows [-----] (no data).

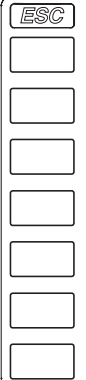
	Displays Reset when the integration value is reset and the integration is ready to be started.		Displays Start during	Displays Stop when integration is aborted, cancelled, or done.	Displays Ready at Element1 when only Element1 is ready in the real-time integration	
Urms1	94.26	V		U1 100V I1 10V Integ:Start U2 1000V I2 5A Integ:Start U3 1000V I3 50A Integ:Start U4 1000V I4 50A Integ:Start U5 1000V I5 50A Integ:Start U6 1000V I6 50A Integ:Start	U1 100V I1 10V Integ: Stop U2 1000V I2 5A Integ: Stop U3 1000V I3 50A Integ: Stop U4 1000V I4 50A Integ: Stop U5 1000V I5 50A Integ: Stop U6 1000V I6 50A Integ: Stop	U1 1000V I1 5A Integ:Ready U2 1000V I2 5A Integ: Stop U3 1000V I3 50A Integ: Stop U4 1000V I4 50A Integ: Stop U5 1000V I5 50A Integ: Stop U6 1000V I6 50A Integ: Stop
Umn1	94.30	V				
Udc1	0.00	V				
Uac1	94.26	V				

**Performing Integration in the Real-time Integration Mode**

1. Check that the integration mode is set to real-time normal integration (R-Normal) or real-time repetitive integration (R-Continuous). See section 6.9.
2. Check that the integration timer and the reservation time are specified. See section 6.9.

- **Starting the integration**

3. Press **START**. The START indicator above and to the left of the key blinks and the instrument enters the ready condition. When the reservation time for starting the integration is reached, the START indicator changes to illumination and the integration is started.

- **Holding the integration**

4. Press **HOLD**. The HOLD indicator illuminates, and the numerical data display is held. Integration continues.

- **Releasing the Held Condition**

5. Press **HOLD** while the values are held. The HOLD indicator turns OFF, and the numerical data display is updated. In the held condition, the display can be updated by carrying out single measurements (by pressing SHIFT + HOLD (SINGLE)).

- **Stopping the integration**

6. Press **STOP**. The START indicator turns OFF and the STOP indicator illuminates. The integration time and integration value are held. If you press STOP before the time specified by the integration timer is reached and then press START, integration continues up to the time specified by the integration timer.

If the reservation time for stopping the integration is reached in the real-time normal integration mode, the START indicator turns OFF and the STOP indicator illuminates. The integration time and integration value are held.

If the time specified by the integration timer elapses in the real-time repetitive integration mode, the integration time and integration value are automatically reset, and the integration is repeated until STOP is pressed or when the reservation time for stopping the integration is reached..

- **Resetting the Integration**

7. Press **SHIFT+STOP (RESET)**. The STOP indicator turns OFF, the integration time and integration value are reset, and the display shows [-----] (no data).

**Note**

In addition to Reset, Start, Stop, and Ready, the following integration states are possible.

- **TimeUp:** When the time set on the integration timer elapses, integration automatically stops. This is called the TimeUp state.
- **Error:** If a power failure occurs when integration is in progress, the integration result is held. When the power recovers, the integration result calculated up to the point when the power failure occurred is displayed with the integration operation stopped. This is called the Error state.

**Explanation**

**Starting, Stopping, and Resetting the Integration**

- The integration can be started, stopped, or reset from the front panel keys or through communication commands.
- Communication commands allow starting, stopping, and resetting the integration of individual elements. To perform all element simultaneous integration from the front panel keys when performing integration on individual elements through communication commands, the operation must be switched to collective operation from individual operation using communication commands or front panel keys.
- The following figure shows the relationship between the integration operation and start, stop, and reset. Pressing RESET after the integration has stopped resets the integration value and the integration time.

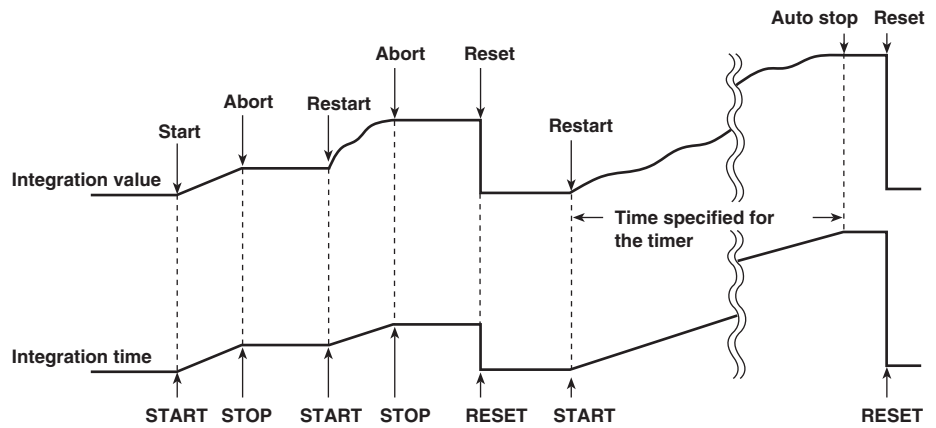

**Holding, Starting, and Stopping the Integration**

When the display is held, the display of the integration result and communication output is held. The integration operation continues regardless of whether the hold function is ON. The relationship between the hold function and the start and stop operations are as follows.

- If the integration is started while the display is held, the display and communication output do not change. When the hold function is released (OFF) or a single measurement (by pressing HOLD (SINGLE) after pressing SHIFT) is made, the integration result at that point is displayed or output via communications.

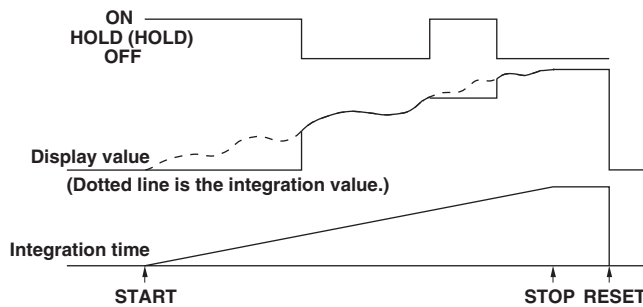

**Note**

- The reservation time (section 6.9) allows up to 31 days to be specified for February. If an erroneous date is specified, an error message is displayed at the time of execution of the integration operation. Reset the reservation time in this case.
- Leap years are recognized at the time of execution of the integration operation.
- The data update rate cannot be changed while the integration is in progress.
- You can set the individual element integration through key operation, but the execution of integration can only be done through communication commands. Even if Independent Control is set to ON (individual element integration ON), the WT1600 operates in the same fashion when Independent Control is OFF (individual element integration OFF).

- If the integration is stopped while the display is held, the display and communication output values do not change from the held values. When the hold function is released (OFF) or a single measurement (by pressing HOLD (SINGLE) after pressing SHIFT) is made, the integration result at the time the integration was stopped is displayed or output via communications.

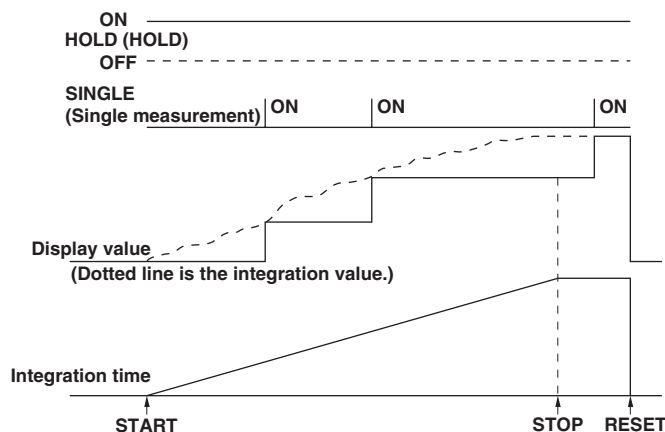

#### Sample Rate and the Allowable Frequency Range for Integration

The sample rate is approximately 200 kHz. The voltage/current signal frequencies that can be integrated are as follows.

Integrated Item	Allowable Frequency Range for Integration
Active power	DC to 100 kHz
Current	When integrating $I_{rms}$
	When integrating $I_{mn}$
	When integrating $I_{dc}$
	When integrating $I_{ac}$
	DC, lower limit of frequency determined by the data update rate to 100 kHz
	DC, lower limit of frequency determined by the data update rate to 100 kHz
	DC to 100 kHz
	DC, lower limit of frequency determined by the data update rate to 100 kHz

#### Display Resolution

The maximum display resolution of integration value is 999999. When the integrated value reaches 1000000 counts, the decimal point shifts automatically. For example, if 0.001 mWh is added to 999.999 mWh, the display shows 1.00000 Wh. For the number of displayed digits other than during integration, see section 1.4.

#### Display When Integration Overflow Occurs

When the integration time reaches its maximum (10000 hours) or the integration value reaches its maximum or minimum ( $\pm 999999$  MWh or  $\pm 999999$  MAh), the integration is stopped and the integration time and integration value at that point are held.

#### Integration When MAX Hold Function Is Enabled

The integration value is determined and displayed by summing the value that is measured at every display update rate, irrespective of the MAX hold function (section 5.9).

#### Integration When the Measured Value Exceeds the Measurement Limit

If the instantaneous voltage or current of the sampled data exceeds 300% of the measurement range when the crest factor is set to 3, the value is considered to be the value corresponding to 300% for the purpose of integration. If the instantaneous voltage or current of the sampled data exceeds 600% of the measurement range when the crest factor is set to 6, the value is considered to be the value corresponding to 600% for the purpose of integration.

## 6.11 Performing Integration (Start, Stop, and Reset)

### Integration When Current Input Is Small

If Irms or Iac is less than or equal to 0.3% (less than or equal to 0.6% when the crest factor is set to 6) and Imn is less than or equal to 1% (less than or equal to 2% when the crest factor is set to 6) of the measurement range, the current is considered to be zero for the purpose of integration.

### Backup During Power Failures

- If a power failure occurs when integration is in progress, the integration result is held. When the power recovers, the integration result calculated up to the point when the power failure occurred is displayed with the integration operation stopped.
- If the integration is reset after the power recovers, integration can be started once again.

### Limitation on Modifying the Settings during Integration

When the integration is in progress, some of the functions cannot be changed as shown below.

Function	<u>Integration Operation Condition</u>		
	Integration Reset (START indicator) (STOP indicator)	Integrating	Integration Suspended
	OFF OFF	ON OFF	OFF ON
<b>Wiring system</b>	Yes	Yes	Yes
<b>Measurement range</b>	Yes	No	No
<b>Scaling</b>	Yes	No	No
<b>Filter</b>	Yes	No	No
<b>Averaging</b>	Yes	No	No
<b>Synchronization source</b>	Yes	No	No
<b>Hold</b>	Yes	Yes	Yes
<b>Single measurement</b>	Yes	Yes	Yes
<b>Data update rate</b>	Yes	No	No
<b>Display format</b>	Yes	Yes	Yes
<b>Integration mode</b>	Yes	No (Displayable)	No (Displayable)
<b>Integration timer</b>	Yes	No (Displayable)	No (Displayable)
<b>Integration start</b>	Yes	No	Yes
<b>Integration stop</b>	No	Yes	No
<b>Integration reset</b>	Yes	No	Yes
<b>Waveform data acquisition</b>	Yes	No	No
<b>Harmonic measurement</b>	Yes	No	No
<b>Store (excludes integration synchronization mode)</b>	Yes	Yes	Yes
<b>Printer</b>	Yes	Yes	Yes
<b>Zero-level crossing</b>	Yes	No	No
<b>Null</b>	Yes	No	No

- Yes: Settings can be modified.
- No: Settings cannot be modified.
- Starting integration in auto range mode switches the measurement range to fixed range mode.

# 7.1 Setting the Harmonic Measurement Mode

## Keys

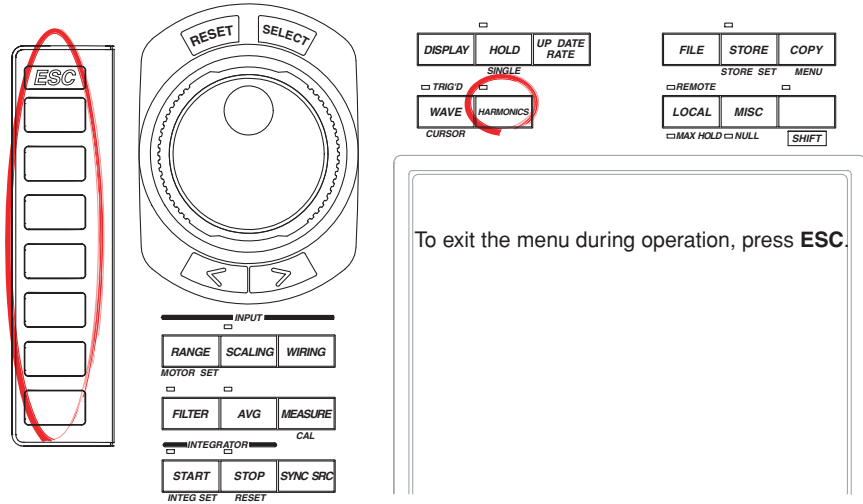

## Procedure

1. Press **HARMONICS** to display the Harmonics menu.

### Turning ON/OFF the Harmonics Measurement Mode

2. Press the **Mode** soft key to select ON or OFF. When turned ON, the HARMONICS indicator above and to the left of the key illuminates.

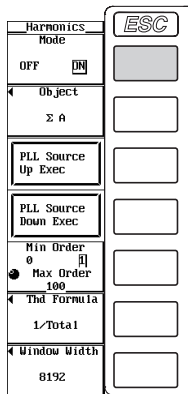

## Explanation

To perform harmonic measurement, the harmonic measurement mode must be enabled.

- ON: Performs harmonic measurement.
- OFF: Does not perform harmonic measurement. Normal measurement is performed.

### Note

- The setup menu may be different when in the normal measurement mode and in the harmonic measurement mode. When setting the instrument, check which measurement mode the instrument is in.
- The frequency measurement target is common to normal measurement and harmonic measurement. For the procedure in selecting the frequency measurement target, see section 6.3.

## 7.2 Changing the Displayed Item of Numerical Data

«For a functional description, see section 1.4.»

### Keys

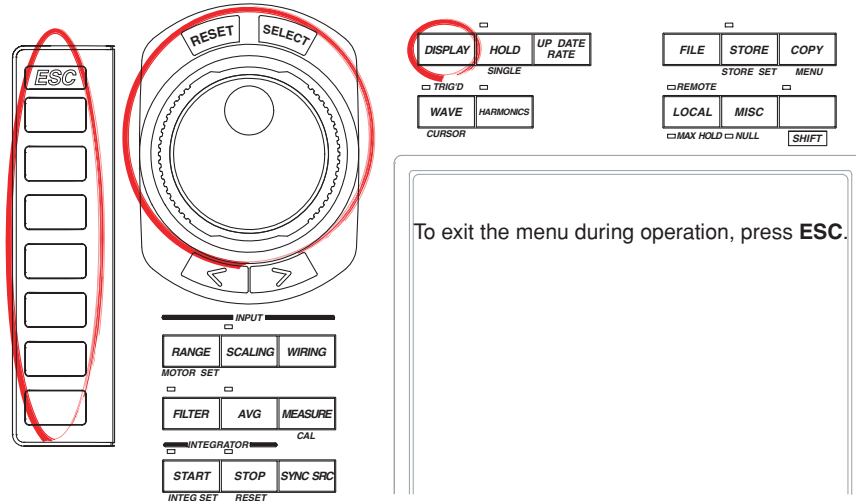

### Procedure

Check that the measurement mode is set to harmonic measurement. If the measurement mode is set to normal measurement, set Mode to ON in the Harmonics menu (see section 7.1).

1. Press **DISPLAY** to display the Display menu.  
 Check that Format (display format) is set to Numeric, Numeric+Wave, Numeric+Bar, or Numeric+Trend. For the display format of the numerical display, see section 4.1.  
 If Item Amount (number of displayed items) is set to 4 (2), 8 (4), or 16 (8), proceed to step 2.  
 If Item Amount (number of displayed items) is set to Single List or Dual List, proceed to step 13.  
 For details on setting the number of displayed items, see section 4.1.

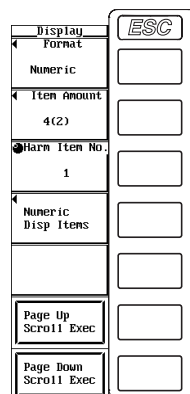

The following procedures are given for a representative example in which the display format is set to Numeric.

**When Item Amount (Number of Displayed Items) Is Set to 4 (2), 8 (4), or 16 (8)**

2. Press the **Numeric Disp Items** soft key to display the Numeric Items menu.

• **Selecting the Item to Be Changed**

3. Press the **Harm Item No.** soft key.
4. Turn the **jog shuttle** to select the item to be changed. The item to be changed is highlighted.

• **Changing the measurement function**

5. Press the **Function** soft key to display the measurement function selection box.
6. Turn the **jog shuttle** to select any of the measurement function starting with None.
7. Press **SELECT**. The symbol for the selected measurement function and the numerical data are displayed at the highlighted position.

• **Changing the element/wiring unit**

8. Press the **Element** soft key to display the element and wiring unit selection box.
9. Turn the **jog shuttle** to select any of the elements/wiring units starting with Element1.
10. Press **SELECT**. The symbol for the selected element number or wiring unit and the numerical data are displayed at the highlighted position.

• **Changing the harmonic order**

11. Press **Order** soft key.
12. Turn the **jog shuttle** to set the order. The specified harmonic order and the numerical data are displayed at the highlighted position.

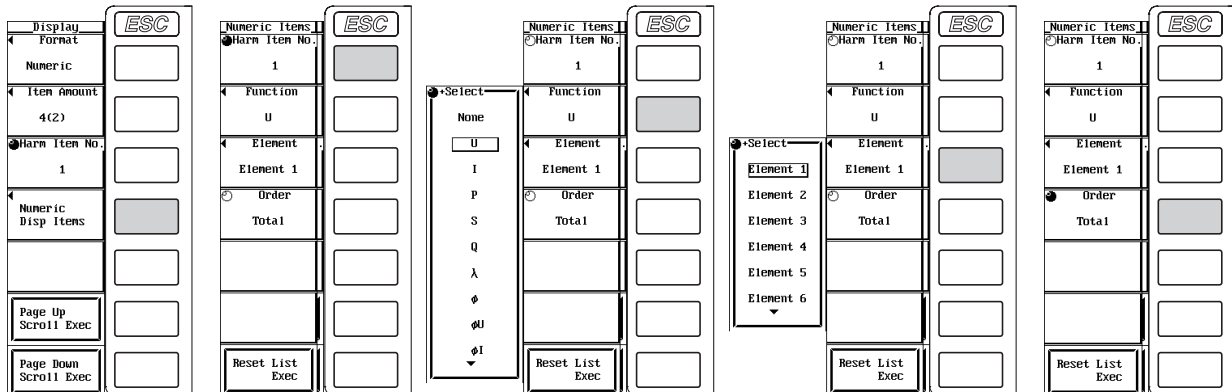



## 7.2 Changing the Displayed Item of Numerical Data

- **Resetting the order of the displayed items**

3. Press the **Reset List Exec** soft key. The order of the displayed items is reset.
4. Turn the **jog shuttle** to select OK or Cancel.
5. Select OK and press **SELECT** to execute the reset of the order of the displayed items.  
Select Cancel and press **SELECT** to abort the reset of the order of the displayed items.

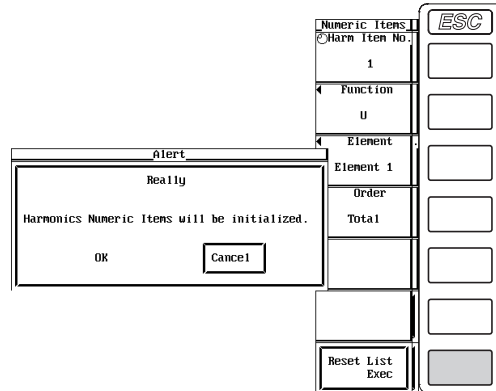

### When Item Amount (Number of Displayed Items) is set to Single List or Dual List

13. Press the **List Items** soft key to display the List Items menu.

- **Selecting the item to be changed**

14. Press the **List Item No.** soft key.
15. Turn the **jog shuttle** to select 1 or 2.
  - When Item Amount is set to Single List, the data of List Item No. 1 is displayed using two columns.
  - When Item Amount is set to Dual List, the data of List Item No. 1 and 2 is displayed in each column.

- **Changing the measurement function**

16. Press the **Function** soft key to display the measurement function selection box.
17. Turn the **jog shuttle** to select the measurement function.
18. Press **SELECT**. The symbol for the selected measurement function and the numerical data are displayed.

- **Changing the element/wiring unit**

19. Press the **Element** soft key to display the element/wiring unit selection box.
20. Turn the **jog shuttle** to select any of the elements/wiring units starting with Element1.
21. Press **SELECT**. The symbol for the selected element number or wiring unit and the numerical data are displayed.

- **Changing the harmonic order**
  22. Press **ESC** to return to the Display menu.
  23. Turn the **jog shuttle** to set the harmonic order. The display is scrolled, and the specified harmonic order and the numerical data are displayed. You can also page-scroll (see section 4.1).

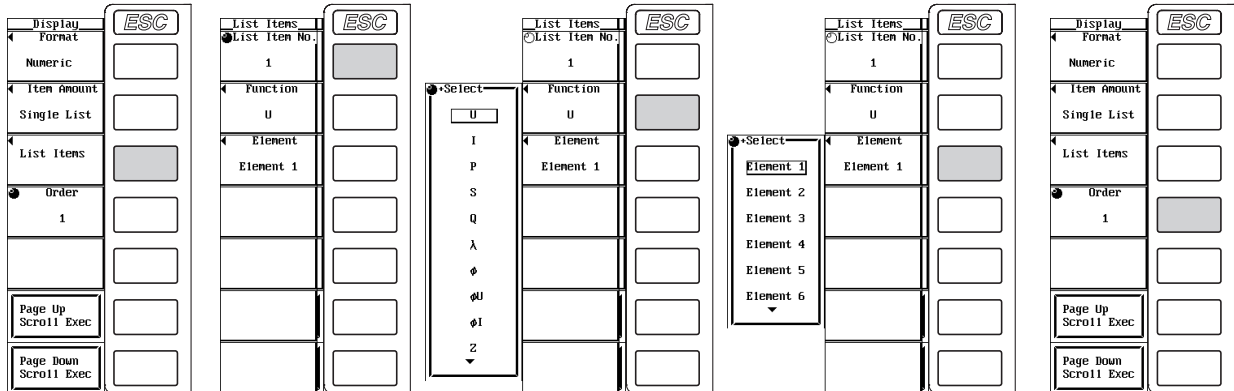

**Explanation**

**When Item Amount (Number of Displayed Items) Is Set to 4 (2), 8 (4), or 16 (8)**

- **Changing the measurement function**
  - The types of measurement functions that can be selected are indicated in “Measurement Function Types for Harmonic Measurement” in section 1.2 and “User-Defined Functions” in section 1.5.
  - You can also select not to display the measurement functions (None).
- **Changing the element/wiring unit**
  - You can select the element/wiring unit from the following list of choices. The selectable items vary depending on the installed elements. Element1, Element2, Element3, Element4, Element5, Element6,  $\Sigma A$ ,  $\Sigma B$ , and  $\Sigma C$
  - If the selected wiring unit is not a harmonic measurement target, there is no numerical data. Thus, [-----] (no data) is displayed in this case. For example, if the measurement target is  $\Sigma A$ , [-----] (no data) is displayed at the measurement function of  $\Sigma C$ . For selecting the measurement target, see section 7.3.

## 7.2 Changing the Displayed Item of Numerical Data

- **Changing the harmonic order**

The harmonic order can be set to total or from dc (0th order) up to 100th order.

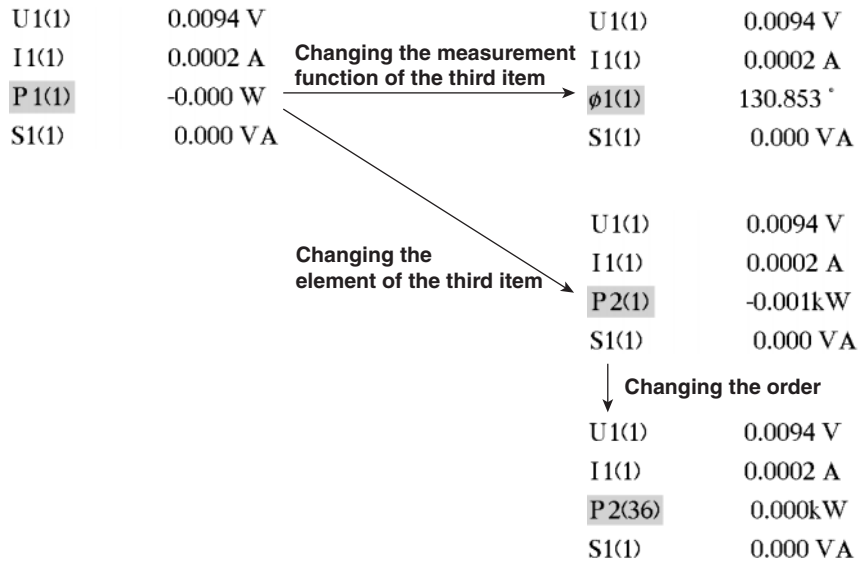

### When Item Amount (Number of Displayed Items) is set to Single List or Dual List

Two types of lists are available. When set to Single List, the data of List Item No. 1 is displayed using two columns. When set to Dual List, the data of List Item No. 1 and 2 is displayed in each column.

You can set the list item No. to 1 or 2.

- **Changing the measurement function**

Select the measurement function to be changed from the following list of choices.

U, I, P, S, Q, λ, φ, φU, φI, Z, Rs, Xs, Rp, and Xp

- **Changing the element/wiring unit**

The description is the same as with the aforementioned “When Item Amount (Number of Displayed Items) Is Set to 4 (2), 8 (4), or 16 (8).”

- **Changing the harmonic order**

The description is the same as with the aforementioned “When Item Amount (Number of Displayed Items) Is Set to 4 (2), 8 (4), or 16 (8).”

### Note

- For the meanings of the measurement function symbols that are displayed, see section 1.2, “Measurement Functions and Measurement Periods,” 1.5, “Computation,” and appendix 1, “Symbols and Determination of Measurement Functions.”
- For details on the wiring units expressed as ΣA, ΣB, and ΣC, see section 5.1, “Selecting the Wiring System.”
- [-----] (no data) is displayed in places where the measurement function is not selected or where numerical data is not present.
- The harmonic order can be set to total or from dc (0th order) up to 100th order. However, the numerical data up to the order corresponding to the upper limit of harmonic order under analysis (see section 17.6) that is automatically determined by the frequency of the PLL source is the data determined by the harmonic measurement.

## 7.3 Selecting the Measurement Target

### Keys

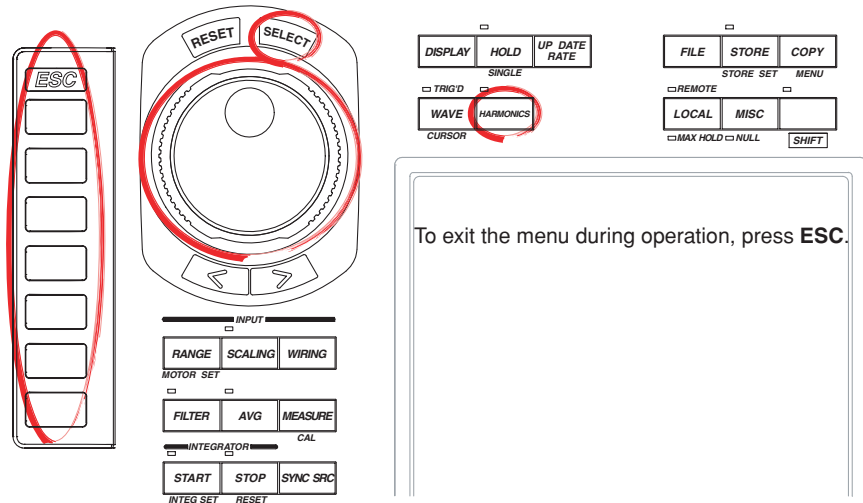

To exit the menu during operation, press **ESC**.

### Procedure

1. Press **HARMONICS** to display the Harmonics menu.
2. Press the **Mode** soft key to select ON.
3. Press the **Object** soft key to display the measurement target selection box.
4. Turn the **jog shuttle** to select the measurement target (wiring unit).
5. Press **SELECT** to confirm.

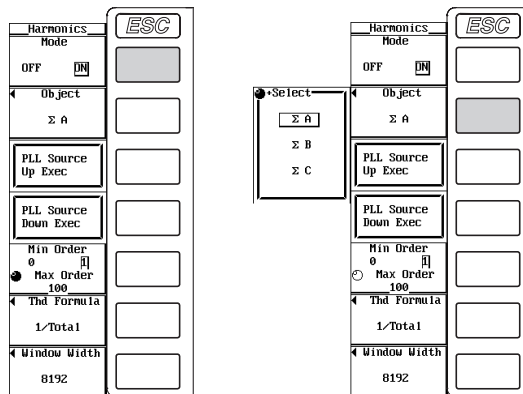

### Explanation

You can select the target wiring unit for the harmonic measurement from the following list of choices. The selectable items vary depending on the selected wiring system pattern.  $\Sigma A$ ,  $\Sigma B$ , and  $\Sigma C$

### Note

For the procedure in selecting the frequency measurement target, see section 6.3.

## 7.4 Selecting the PLL Source

«For a functional description, see section 1.2.»

### Keys

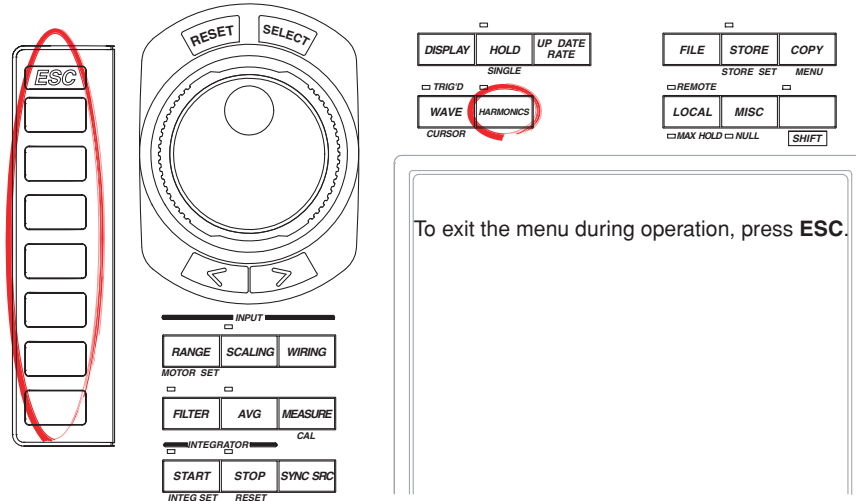

### Procedure

1. Press **HARMONICS** to display the Harmonics menu.
2. Press the **Mode** soft key to select ON.
3. Press the **PLL Source Up Exec** or **PLL Source Down Exec** soft key to select the PLL source. The selected PLL source is displayed at the upper right corner of the screen at PLL Src.
  - Pressing the PLL Source Up Exec soft key makes the target element for the PLL source smaller.
  - Pressing the PLL Source Down Exec soft key makes the target element for the PLL source larger.

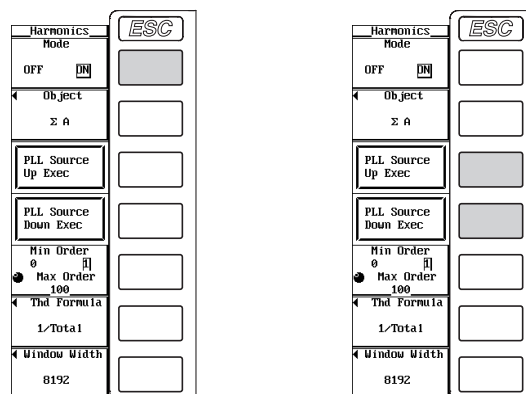

**Explanation**

Set the PLL (phase locked loop) source that is used to determine the fundamental period, which acts as the reference in the analysis of the harmonic orders.

**Displayed Position of the Selected PLL Source**

The selected PLL source is displayed at the upper right corner of the screen when HARMONICS is pressed.

Below is a display example when the PLL source is set to the voltage of Element1.

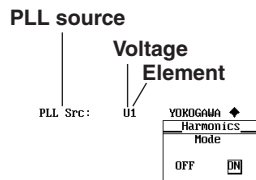
**Selecting the PLL Source**

Select the PLL source from the following list of choices. The selectable items vary depending on the installed elements.

U1, I1, U2, I2, U3, I3, U4, I4, U5, I5, U6, I6, Ext Clk\*, and Smp Clk\*

\* If you select "Ext Clk," harmonic measurement is performed using the frequency of the signal applied to the external clock input connector as the fundamental frequency. If you select "Smp Clk," harmonic measurement is performed using  $(1/2048) \times$  the frequency of the signal applied to the external clock input connector as the fundamental frequency.

**When the PLL Source Is Set to Ext Clk or Smp Clk**

Apply a clock signal to the external clock input connector (EXT CLK) on the rear panel according to the following specifications.

**• Ext Clk specifications**

Item	Specification
Connector type	BNC connector, same as the Smp Clk connector, simultaneous input with Smp Clk is not allowed.
Frequency range	10 Hz to 1 kHz
Input level	TTL
Input waveform	50% duty ratio rectangular wave

**• Smp Clk specifications**

Item	Specification
Connector type	BNC connector, same as the Ext Clk connector, simultaneous input with Ext Clk is not allowed.
Frequency range	Frequency equal to 2048 times the fundamental frequency of 0.5 Hz to 100 Hz
Input level	TTL
Input waveform	50% duty ratio rectangular wave

**CAUTION**

Applying a voltage outside the range of 0 to 5 V to the external clock input connector (EXT CLK) can damage the instrument.

### **Note**

---

- The frequency of up to three signals including the signals selected for the PLL source as fU (voltage frequency) or fI (current frequency) can be measured. For the procedure in selecting the frequency measurement target, see section 6.3. If the number of frequency measurement targets exceeds three because you selected a PLL source other than the source selected in section 6.3, frequency measurement targets are removed in order from the element with the largest number in the order voltage and current.
  - Select a signal that has the same period as the target signal for the harmonic measurement. Selecting an input signal with little distortion for the PLL source enables stable harmonic measurement. If the fundamental frequency of the PLL source fluctuates or if the fundamental frequency cannot be measured due to waveform distortion, correct measurement results will not be obtained. It is recommended that the voltage of the PLL source be set so that the distortion is small with respect to the current.  
If all the input signals are distorted or the amplitude level is small with respect to the measurement range, the specifications may not be met. To achieve accurate measurements on the high orders of the harmonics, set the PLL source to external clock and apply a signal with the same period as the input signal to the external clock input connector.
  - If the fundamental frequency is less than or equal to 440 Hz and the signal contains high frequency components, it is recommended that the zero crossing filter be set to 500 Hz. The cut-off frequency of this filter is 500 Hz and is valid only for the frequency measurement circuit.
  - If the amplitude level of the signal input to the element specified as the PLL source is small with respect to the range, PLL synchronization may not be achieved. If the crest factor is set to 3, set the measurement range so that the amplitude level of the PLL source is at least 30%. If the crest factor is set to 6, set the measurement range so that the amplitude level of the PLL source is at least 60%.
  - When the PLL source frequency changes, the correct measured values are displayed starting from the 4th data update after the change.
-

# 7.5 Setting the Harmonic Order to Be Analyzed

## Keys

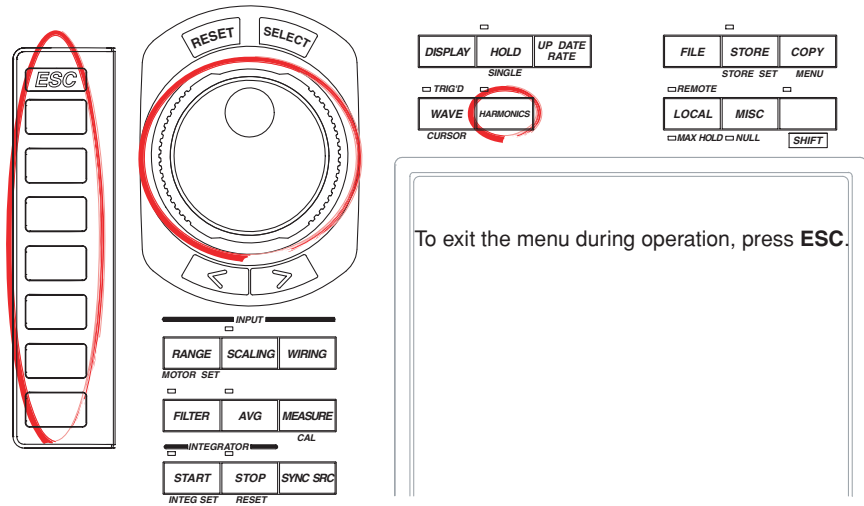

## Procedure

1. Press **HARMONICS** to display the Harmonics menu.
2. Press the **Mode** soft key to select ON.

### Selecting the Minimum Harmonic Order to Be Analyzed

3. Press the **Min Order** soft key to select 0 or 1.

### Selecting the Maximum Harmonic Order to Be Analyzed

4. Turn the **jog shuttle** to set the maximum harmonic order to be analyzed.

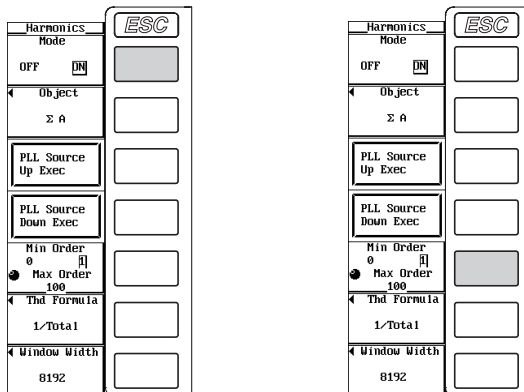



## 7.5 Setting the Harmonic Order to Be Analyzed

---

### Explanation

Select the range of harmonic orders that will be used to determine the numerical data of Total and the distortion factor of the harmonic waveform. For details on how to determine the data, see appendix 1.

### Selecting the Minimum Harmonic Order to Be Analyzed

You can select from the following list of choices.

- 0: Includes the 0th order (DC) component when determining the various numerical data of the harmonic waveform.
- 1: Does not include the 0th order (DC) component when determining the various numerical data of the harmonic waveform. 1st order (fundamental signal) is the first component used.

### Setting the Maximum Harmonic Order to Be Analyzed

Select the harmonic order in the range from 1 to 100th order.

### Note

- When the minimum harmonic order is set to 1, the numerical data representing the total of the harmonic measurement data will not include the DC component.
  - You can set the maximum harmonic order up to 100th order, but the maximum harmonic order that is actually used to determine the numerical data is the order corresponding to the upper limit of harmonic order under analysis. The upper limit is determined automatically (maximum is 100) by the frequency of the PLL source. The numerical data corresponding harmonic orders exceeding the upper limit is shown as [-----] (no data).
-

## 7.6 Selecting the Equation for the Distortion Factor

### Keys

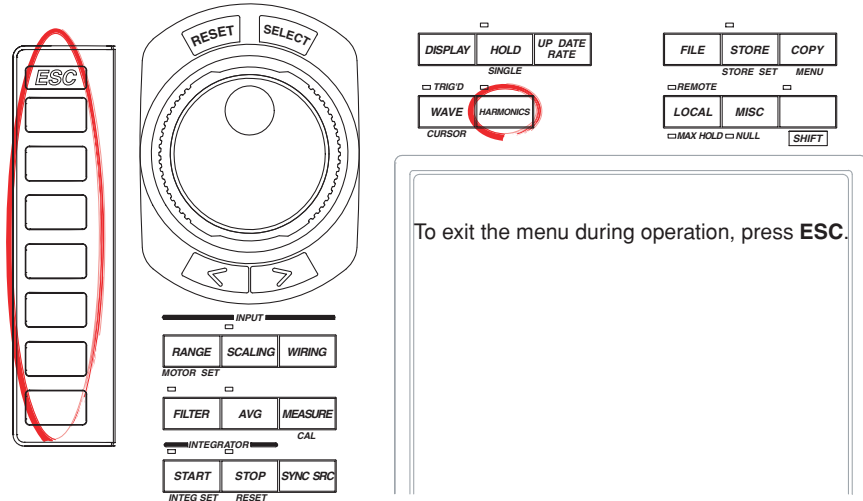

### Procedure

1. Press **HARMONICS** to display the Harmonics menu.
2. Press the **Mode** soft key to select ON.
3. Press the **Thd Formula** soft key to display the Thd Formula menu.
4. Press the **1/Total** or **1/Fundamental** soft key to select the equation for the distortion factor.

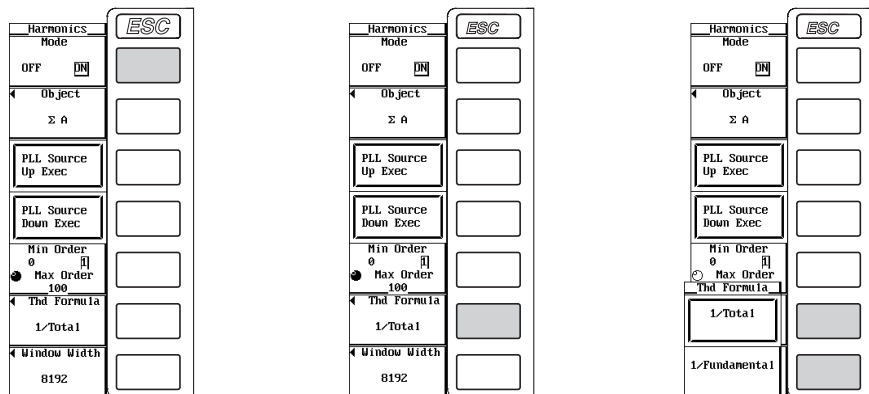

### Explanation

When determining the measurement functions  $U_{hdf}$ ,  $I_{hdf}$ ,  $P_{hdf}$ ,  $U_{thd}$ ,  $I_{thd}$ , and  $P_{thd}$  of the harmonic measurement mode, select the denominator of the equation from the following list of choices. For the equation, see appendix 1.

- **1/Total**  
All harmonic measurement data from the minimum to the maximum harmonic order (up to the upper limit of harmonic order) to be analyzed become the denominator.
- **1/Fundamental**  
The data of the fundamental signal component (1st order) become the denominator.

#### Note

The minimum and maximum harmonic orders to be analyzed are the components selected in section 7.5.

## 7.7 Changing the Data Length

### Keys

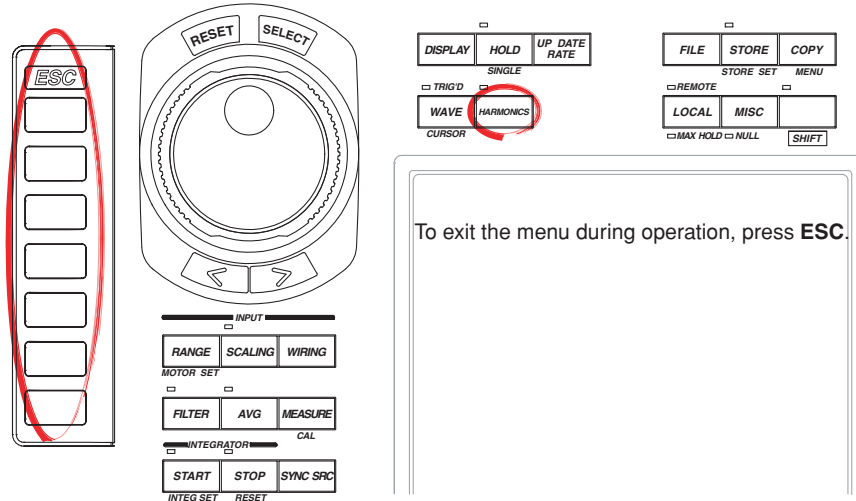

### Procedure

1. Press **HARMONICS** to display the Harmonics menu.
2. Press the **Mode** soft key to select ON.
3. Press the **Window Width** soft key to display the Window Width menu.
4. Press one of the **8192** to **2048** soft keys to select the window width to be analyzed.

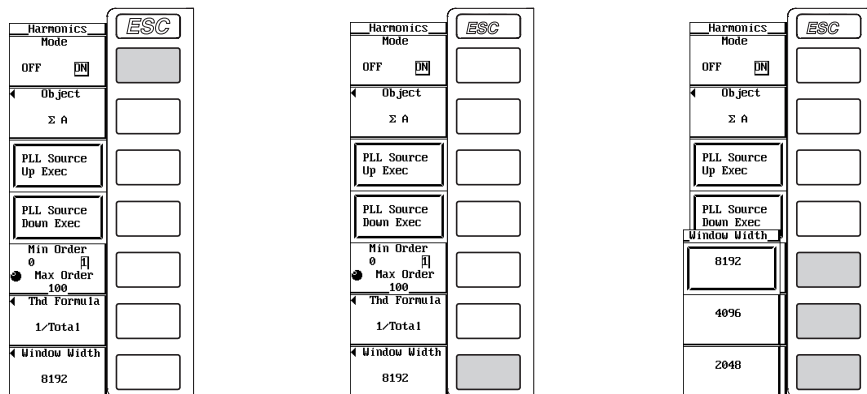

### Explanation

You can select the target data length (number of sampled data) for the harmonic measurement from the following list of choices. The selected data length becomes the measurement period. When the waveform is displayed, the measurement period corresponds to one screen of the waveform.

8192, 4096, and 2048

#### Note

The data update rate (interval) during harmonic measurement is as follows:

- When all the following conditions are met: a data length of 8192, retrieval of waveform display data turned OFF, and a PLL source frequency of 50/60 Hz.  
 $\{8192 / (\text{sampling frequency during harmonic measurement})\} \text{ s}$
- For all other conditions  
 $\{\text{data length} / (\text{sampling frequency during harmonic measurement}) + \text{approx. } 0.5\} \text{ s}$

## 7.8 Setting the User-Defined Function

### Keys

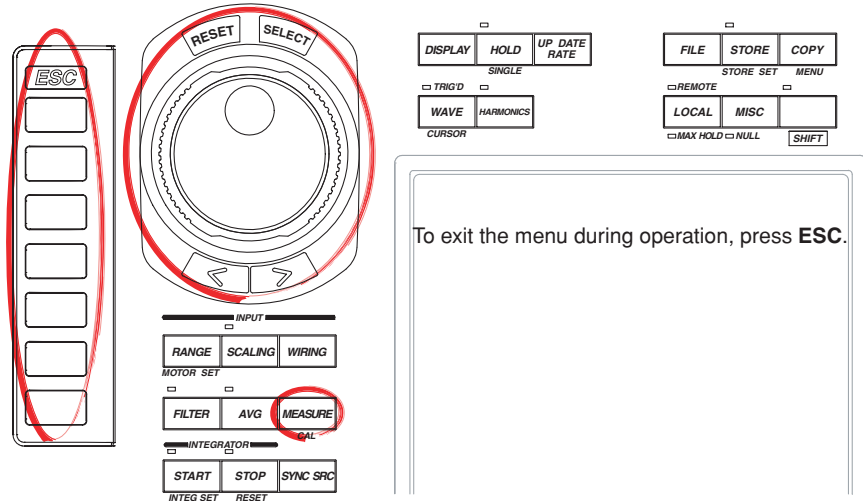

### Procedure

Check that the measurement mode is set to harmonic measurement. If the measurement mode is set to normal measurement, set Mode to ON in the Harmonics menu (see section 7.1).

1. Press **MEASURE** to display the Measure menu.
2. Press the **User Defined** soft key to display the User Defined Function dialog box.

### Turning ON/OFF the User-Defined Function Computation

3. Turn the **jog shuttle** to select the user-defined function you wish to enter from Function1 to Function4.
4. Press **SELECT** to select ON or OFF.

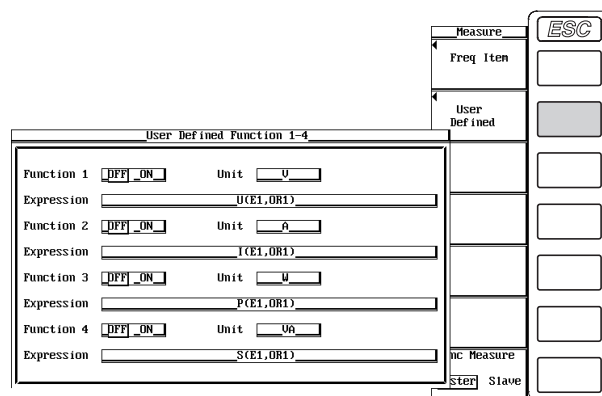

## 7.8 Setting the User-Defined Function

### Setting the Unit

5. Turn the **jog shuttle** to select Unit.
6. Press **SELECT** to display the keyboard.
7. Use the **keyboard** to set the unit.

For keyboard operations, see section 3.12, "Entering Values and Strings."

### Setting the Equation

8. Turn the **jog shuttle** to select Expression.
9. Press **SELECT** to display the keyboard.
10. Use the **keyboard** to set the equation.

For keyboard operations, see section 3.12, "Entering Values and Strings."

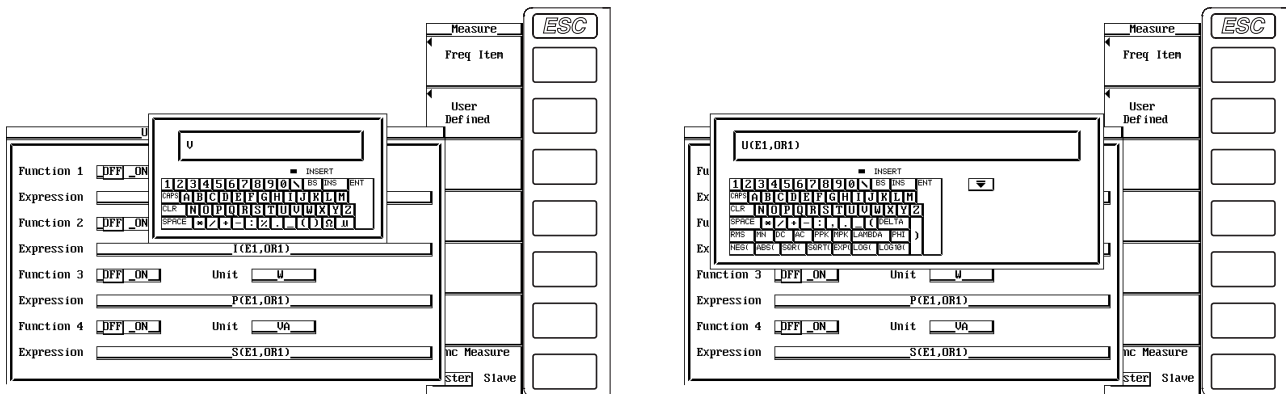

### Explanation

An equation can be created by combining the measurement function symbols. Using the numerical values of the measurement functions, the numerical data of the new equation can be determined.

### Turning ON/OFF the User-Defined Function

You can select whether to perform the specified user-defined function computation.

- ON  
Performs the computation.
- OFF  
Does not perform the computation.

### Setting the Unit

- Number of Characters  
Eight characters or less. However, not all eight characters can be shown on the numerical data display. This depends on the number of displayed items (see section 4.1).
- Types of characters  
Characters that are displayed on the keyboard and spaces

### Setting the Equation

The combination of the measurement function, element number, and harmonic order (U(E1,OR1), for example) can be used as an operand to create up to four equations (F1 to F4). There can be up to 16 operands in one equation.

- **Measurement functions for computation**

The operators for the measurement functions are shown below in the form

**measurement function: operand.**

U: U( , )	I: I( , )	P: P( , )
S: S( , )	Q: Q( , )	$\lambda$ : LAMBDA( , )
$\phi$ : PHI( , )	$\phi$ U: UPHI( , )	$\phi$ l: IPHI( , )
Z: Z( , )	Rs: RS( , )	Xs: XS( , )
Rp: RP( , )	Xp: XP( , )	Uhdf: UHDF( , )
lhdf: IHDF( , )	Phdf: PHDF( , )	Uthd: UTHD( )
lthd: ITHD( )	Pthd: PTHD( )	Uthf: UTHF( )
lthf: ITHF( )	Utif: UTIF( )	Itif: ITIF( )
hvf: HVF( )	hcf: HCF( )	fU: FU( )
fl: FI( )	$\phi$ U1-U2: PHIU1U2( )	$\phi$ U1-U3: PHIU1U3( )
$\phi$ U1-I1: PHIU1I1( )	$\phi$ U1-I2: PHIU1I2( )	$\phi$ U1-I3: PHIU1I3( )

- ( , )A symbol representing the element to which the measured signal is to be applied is entered on the left side. OR followed by the harmonic order is entered on the right side. (E1,OR2) is an example. Elements 1, 2, 3, 4, 5, 6,  $\Sigma$ A,  $\Sigma$ B, and  $\Sigma$ C are represented by the symbols E1, E2, E3, E4, E5, E6, E7, E8, and E9 respectively. One symbol from E1 to E9 can be used, except for the following computation symbols.
  - One symbol from E1 to E6 can be entered in the parentheses for PHI( , ) to FI( ).
  - One symbol from E7 to E9 can be entered in the parentheses for PHIU1U2( ) to PHIU1I3( ).
  - For operands that do not have a comma inside the parentheses, no harmonic order needs to be specified.
- If the harmonic section is set to "ORT," it represents Total; if it is set to "0 (zero)," it represents DC.

## 7.8 Setting the User-Defined Function

---

- **Operators**

The following operators can be used to create the equation.

Operator	Example	Description
+, -, *, /	$U(E1,OR1)-U(E2,OR1)$	Basic arithmetic of the measurement functions
ABS	$ABS(P(E1,ORT)+P(E2,ORT))$	Absolute value of the measurement function
SQR	$SQR(I(E1,OR0))$	Square of the measurement function
SQRT	$SQRT(ABS(I(E1,OR3)))$	Square root of the measurement functions
LOG	$LOG(U(E1,OR25))$	Natural log of the measurement functions
LOG10	$LOG10(U(E1,OR25))$	Common log of the measurement function
EXP	$EXP(U(E1,OR12))$	Exponent of the measurement function
NEG	$NEG(U(E1,OR12))$	Negation of the measurement function

- **Number and Type of Characters That Can Be Used in the Equation**

- Number of Characters  
50 characters or less.
- Types of characters  
Characters that are displayed on the keyboard and spaces

**Note**

---

- An equation (F1 to F4) cannot be placed inside another equation (F1 to F4).
  - If an operand in the equation is undetermined, the computation result displays [-----] (no data).  
(For example, if the measurement function of an element that is not installed is in the equation.)
-

# 7.9 Changing the Display Items of Bar Graphs and Performing Cursor Measurements

«For a functional description, see section 1.8.»

## Keys

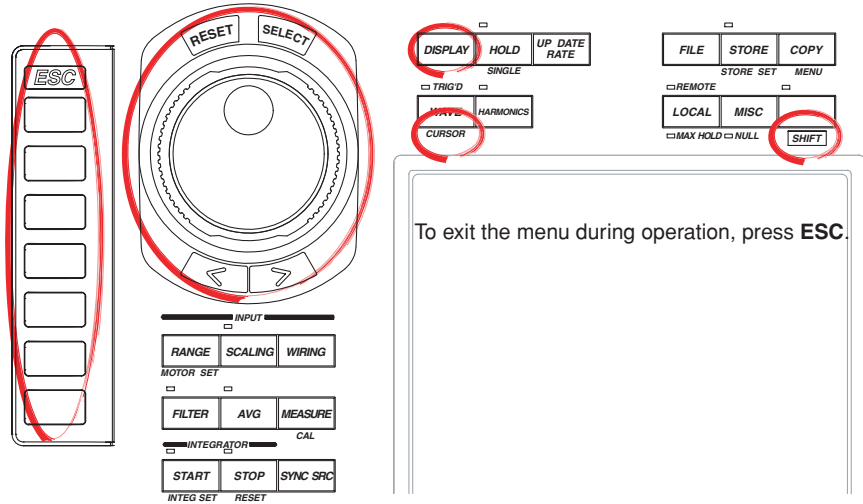

To exit the menu during operation, press **ESC**.

## Procedure

Check that the measurement mode is set to harmonic measurement. If the measurement mode is set to normal measurement, set Mode to ON in the Harmonics menu (see section 7.1).

1. Press **DISPLAY** to display the Display menu.  
Check that Format (display format) is set to Bar, Numeric+Bar, Wave+Bar, or Bar+Trend. For the display format of the bar graph, see section 4.3.  
When the display format is set to Numeric+Bar, Wave+Bar, or Bar+Trend, pressing the Bar Setting soft key displays the Bar Setting menu.

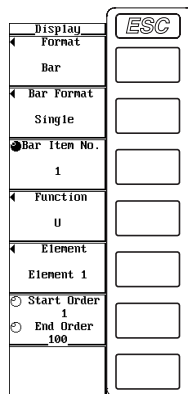



## 7.9 Changing the Display Items of Bar Graphs and Performing Cursor Measurements

The following procedures are given for a representative example in which the display format is set to Bar.

### Selecting the Number of Split Bar Graph Windows

2. Press the **Bar Format** soft key to display the Bar Format menu.
3. Press one of the keys from **Single** to **Triad** to select the number of windows.
  - If you select Single, the bar graph with the Bar Item No. 1 in the next section is displayed.
  - If you select Dual, the bar graphs with the Bar Item No. 1 and 2 in the next section is displayed.
  - If you select Triad, the bar graphs with the Bar Item No. 1 to 3 in the next section is displayed.

### Selecting the Item to Be Changed

4. Press the **Bar Item No.** soft key.
5. Turn the **jog shuttle** to select 1 to 3.

### Changing the Measurement Function

6. Press the **Function** soft key to display the measurement function selection box.
7. Turn the **jog shuttle** to select the measurement function.
8. Press **SELECT**. The symbol for the selected measurement function and the bar graph are displayed.

### Changing the Element

9. Press the **Element** soft key to display the element selection box.
10. Turn the **jog shuttle** to select any of the elements/wiring units starting with Element1.
11. Press **SELECT**. The selected element number and the bar graph are displayed.

### Setting the Display Range of the Bar Graph

The difference between the start and end orders must be greater than or equal to 10.

#### • Setting the start order

12. Press the **Start Order/End Order** soft key to set the jog shuttle target to Start Order.
13. Turn the **jog shuttle** to set the start order of the bar graph.

For the procedures on how to enter values using the jog shuttle, see section 3.12, "Entering Values and Strings."

#### • Setting the end order

14. Press the **Start Order/End Order** soft key to set the jog shuttle target to End Order.
15. Turn the **jog shuttle** to set the end order of the bar graph.

For the procedures on how to enter values using the jog shuttle, see section 3.12, "Entering Values and Strings."

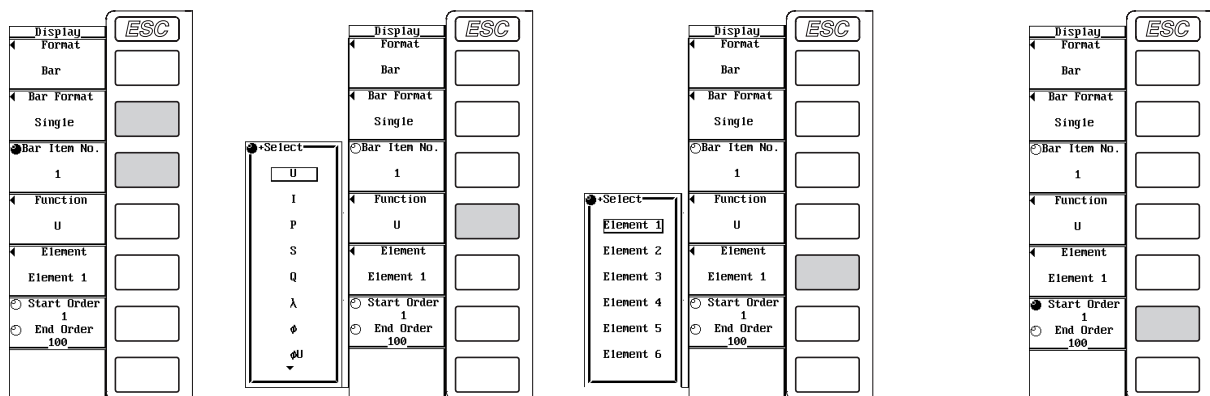

**Performing Cursor Measurements**

2. Press **SHIFT+WAVE (CURSOR)** to display the Cursor menu.

• **Turning ON/OFF cursor measurement**

3. Press the **Bar Cursor** soft key to select ON or OFF.

If ON is selected, the result of the cursor measurement is displayed.

• **Moving the cursor**

4. Press the **Bar C1 +/Bar C2 x** soft key to set the jog shuttle target to Bar C1 +, Bar C2 x, or both Bar C1 + and Bar C2 x.

- If you select Bar C1 +, the position of cursor + can be moved.
- If you select Bar C2 x, the position of cursor x can be moved.
- If you select both Bar C1 + and Bar C2 x, the two cursors can be moved without changing the spacing between the two. The value of the digit being specified by Bar C1 + changes.

5. Turn the **jog shuttle** to set and move the cursor position in terms of the harmonic order.

For the procedures on how to enter values using the jog shuttle, see section 3.12, "Entering Values and Strings."

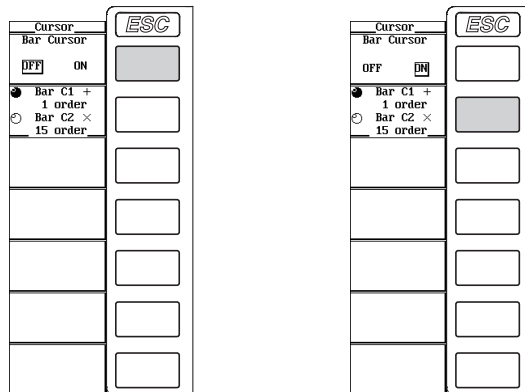

**Explanation**

**Selecting the Item to Be Changed**

Three types of bar graphs can be specified. Select the type from 1 (bar graph 1) to 3 (bar graph 3).

**Changing the Measurement Function**

Select the measurement function to be changed from the following list of choices.

U, I, P, S, Q, λ, φ, φU, φI, Z, Rs, Xs, Rp, and Xp

**Changing the Element**

- Select the element from the following list of choices. The selectable items vary depending on the installed elements.  
Element1, Element2, Element3, Element4, Element5, and Element6
- If the selected element is not a harmonic measurement target, there is no numerical data. Thus, the bar graph is not displayed in this case. For example, if the measurement target is ΣA and you select the element assigned to ΣC, the bar graph will not be displayed. For selecting the measurement target, see section 7.3.

## 7.9 Changing the Display Items of Bar Graphs and Performing Cursor Measurements

---

### Setting the Display Range of the Bar Graph

- Set the display range of the bar graph using harmonic order.
- The display range of bar graph 1 to bar graph 3 is the same.
- The minimum value is 0th order (dc). However, if the measurement function is set to  $\phi$ ,  $\phi U$ , or  $\phi I$ , there is no value for the 0th order. Thus, 0th order is not displayed on the bar graph.
- If the measurement function is set to  $\phi U$  or  $\phi I$ , there is no value for the 1st order. Thus, 1st order is not displayed on the bar graph.
- The maximum value is the 100<sup>th</sup> order. However, bar graphs of orders that exceed the upper limit of harmonic order under analysis (see section 17.6) are not displayed.

### Cursor Measurement

- **ON/OFF**

A cursor can be placed on the displayed bar graph to measure the value at that point.

- ON: Performs cursor measurement.
- OFF: Does not perform harmonic measurement.

- **Measured items**

- Y1+: Y-axis value of cursor + of bar graph 1
- Y1x: Y-axis value of cursor x of bar graph 1
- $\Delta Y1$ : The difference between the Y-axis values of cursor + and cursor x of bar graph 1

- Y2+: Y-axis value of cursor + of bar graph 2
- Y2x: Y-axis value of cursor x of bar graph 2
- $\Delta Y2$ : The difference between the Y-axis values of cursor + and cursor x of bar graph 2

- Y3+: Y-axis value of cursor + of bar graph 3
- Y3x: Y-axis value of cursor x of bar graph 3
- $\Delta Y3$ : The difference between the Y-axis values of cursor + and cursor x of bar graph 3

- **Cursor position**

- Two cursors (+ and x) are displayed in each graph (bar graphs 1 to 3).
- The cursor position is set using harmonic order.
- Bar graph displays the harmonic order indicating the cursor position.
  - The position of cursor + is displayed as in order+: 2.
  - The position of cursor x is displayed as in orderx: 55.
- The harmonic order indicating the positions of cursor + and x are common to bar graph 1 to bar graph 3.

### Note

---

if unmeasurable data exists, "\*\*\*\*" is displayed in the measured value display area.

---

# 7.10 Changing the Vector Display

«For a functional description, see section 1.8.»

## Keys

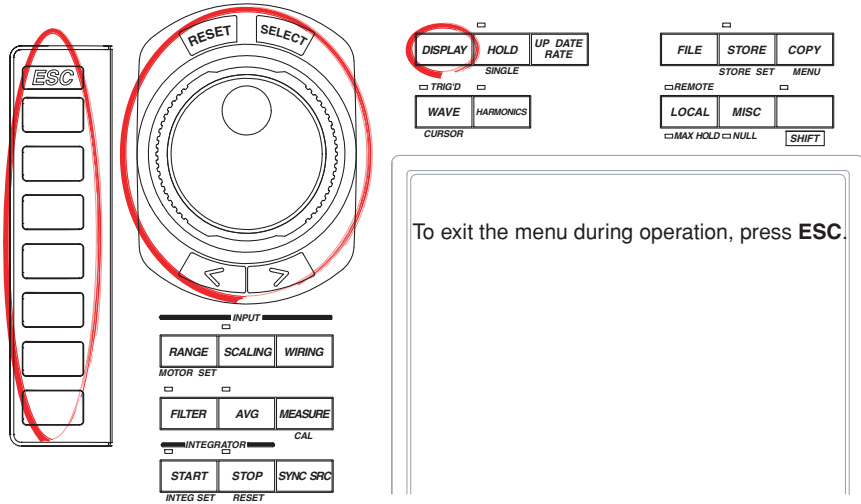

## Procedure

Check that the measurement mode is set to harmonic measurement. If the measurement mode is set to normal measurement, set Mode to ON in the Harmonics menu (see section 7.1).

1. Press **DISPLAY** to display the Display menu. Check that Format (display format) is set to Vector. For the display format of vectors, see section 4.4.

### Turning ON/OFF the Numerical Data Display

2. Press the **Numeric** soft key to select ON or OFF.

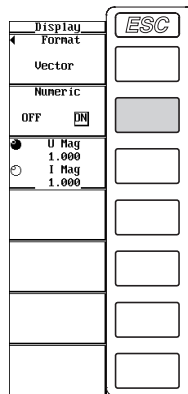

## 7.10 Changing the Vector Display

### Zooming in on the Vector

2. Press the **U Mag/I Mag** soft key to set the jog shuttle target to U Mag, I Mag, or both U Mag and I Mag.
  - If U Mag is selected, you can zoom in on the vector of the fundamental wave U(1) of each element that is specified for harmonic measurement.
  - If I Mag is selected, you can zoom in on the vector of the fundamental wave I(1) of each element that is specified for harmonic measurement.
  - If both U Mag and I Mag is selected, you can zoom in on the vector of the fundamental waves U(1) and I(1) of each element that are specified for harmonic measurement without changing the difference in the zoom factor between U Mag and I Mag. The value of the digit being specified by U Mag changes.
3. Turn the **jog shuttle** to set the zoom factor.

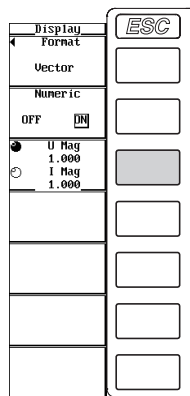

### Explanation

The phase and size (rms value) relationship between the fundamental waves U(1) and I(1) of each element specified for harmonic measurement (see section 7.3) can be displayed using vectors. The positive vertical axis is set to 0 (angle 0), and the vector of each input signal is displayed.

### Turning ON/OFF the Numerical Data Display

Select whether to display the numerical data. The size and the phase difference between the signals can be displayed along with the vector display. For the display format of the phase difference, see section 6.7.

- ON: Displays the numerical data.
- OFF: Does not display the numerical data.

### Setting the Zoom Factor of Vectors

The size of the vectors can be changed.

- The zoom factor can be set in the range of 0.100 to 100.000.
- You can specify separate zoom factors for the fundamental waves U(1) and I(1).

### Vector Display Examples

When displaying numerical data (the size of the signal and the phase difference between signals)

For a 3P4W (three-phase, four-wire) wiring system U1(1), U2(1), and U3(1) are common mode voltages. I1(1), I2(1), and I3(1) are line currents.

For a 3V3A (three-voltage, three-current) wiring system U1(1), U2(1), and U3(1) are line voltages. I1(1), I2(1), and I3(1) are line currents.

For a 3P3W (three-phase, three-wire) wiring system U1(1), U2(1), and U3(1) are line voltages. I1(1), I2(1), and I3(1) are line currents. However, U3(1) and I3(1) are not actually measured for the three-phase three-wire system. The vectors are displayed through computation.

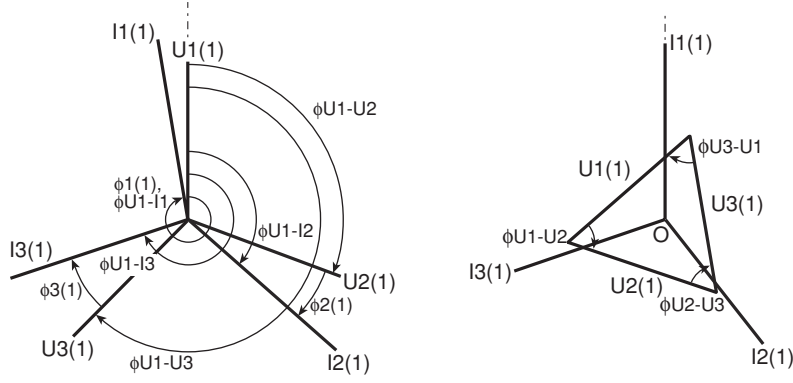
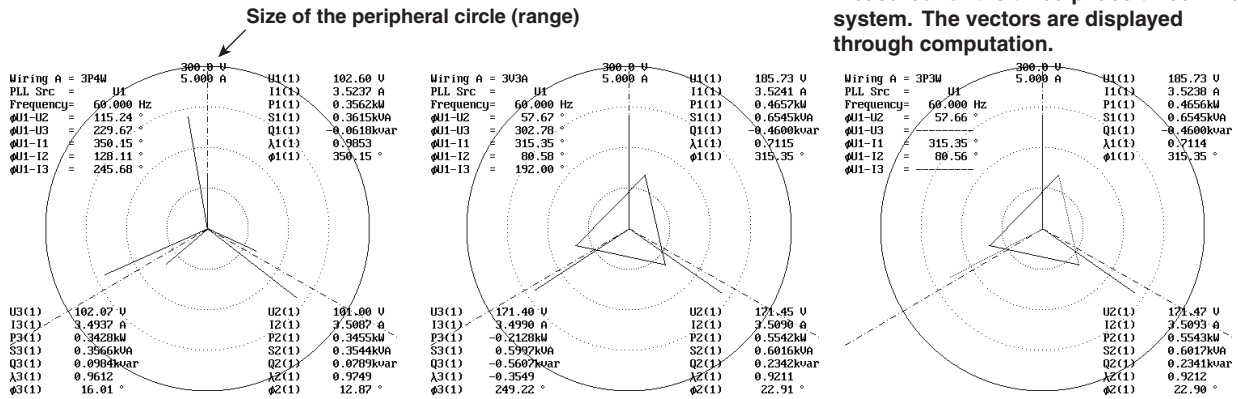

- By moving the vectors, U1(1), U2(1), and U3(1), so that the starting points of vectors are all at the origin, the phase relationship can be observed in the same fashion as the three-phase four-wire system. For the relationship between the positions of the vectors after moving them, see "Vector Display of Harmonics" in section 1.8. (The WT1600 does not provide a function for moving the vectors.)
- The phase difference between the line voltages can be determined from the phase difference measurement functions  $\phi U1-U2$  and  $\phi U1-U3$ .  
 $\phi U1-U2$  = This is the measurement function  $\phi U1-U2$ .  
 $\phi U2-U3 = (\phi U1-U3) - (\phi U1-U2) - 180^\circ$   
 $\phi U2-U3 = (\phi U1-U3) - (\phi U1-U2) - 180^\circ$

When the vector size is zoomed

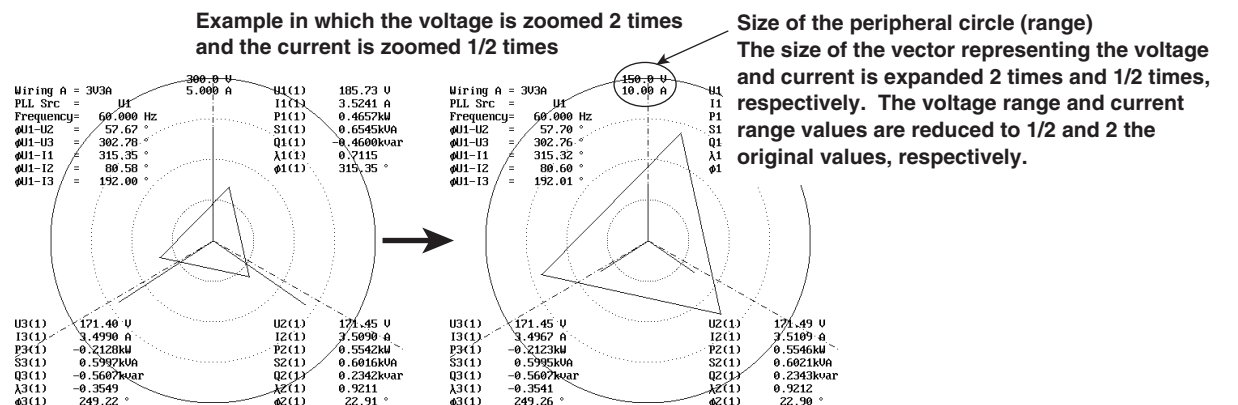

## 8.1 Inputting Signals of Rotating Speed and Torque

The rotating speed, torque, and output of a motor can be determined from the DC voltage (analog signal) or pulse count signal received from a revolution sensor, which is proportional to the rotating speed of the motor, and the DC voltage (analog signal) received from a torque meter, which is proportional to the motor's torque. In addition, the synchronous speed and slip of a motor can be determined by setting the motor's number of poles. Furthermore, the active power and frequency that are measured by the WT1600 and the motor output can be used to compute the motor efficiency and the total efficiency. The motor evaluation function does not operate during harmonic measurement.



### CAUTION

Applying a voltage exceeding the maximum allowable input to the revolution signal input connector (SPEED) or torque signal input connector (TORQUE) can damage the instrument.

### Revolution Signal Input Connector (SPEED)

Input the signal output from the revolution sensor (a DC voltage (analog signal) or a pulse signal that is proportional to the rotating speed of the motor) according to the following specifications.



#### DC Voltage (Analog Input)

Item	Specification
Connector type	BNC connector
Input range	20 V, 10 V, 5 V, 2 V, and 1 V
Effective input range	±110% of the measurement range However, ±20 V or less
Input resistance	Approx. 1 MΩ
Maximum allowable input	±20 V
Continuous maximum common mode voltage	±42 V <sub>peak</sub> or less

#### Pulse Input

Item	Specification
Connector type	BNC connector
Frequency range	2 Hz to 200 kHz
Amplitude input range	±5 V <sub>peak</sub>
Effective amplitude	1 V (peak-to-peak) or more
Input waveform	50% duty ratio rectangular wave
Input resistance	Approx. 1 MΩ
Continuous maximum common mode voltage	±42 V <sub>peak</sub> or less

## 8.1 Inputting Signals of Rotating Speed and Torque

---

### Torque Meter Signal Input Connector (TORQUE)

Input the signal output from the torque meter (a DC voltage (analog signal) that is proportional to the torque of the motor) according to the following specifications.



---

Item	Specification
Connector type	BNC connector
Input range	20 V, 10 V, 5 V, 2 V, and 1 V
Effective input range	$\pm 110\%$ of the measurement range However, $\pm 20$ V or less
Input resistance	Approx. 1 M $\Omega$
Maximum allowable input	$\pm 20$ V
Continuous maximum common mode voltage	$\pm 42$ V <sub>peak</sub> or less

---



## 8.2 Selecting the Input Range of the Revolution and Torque Signals and the Synchronization Source

### Keys

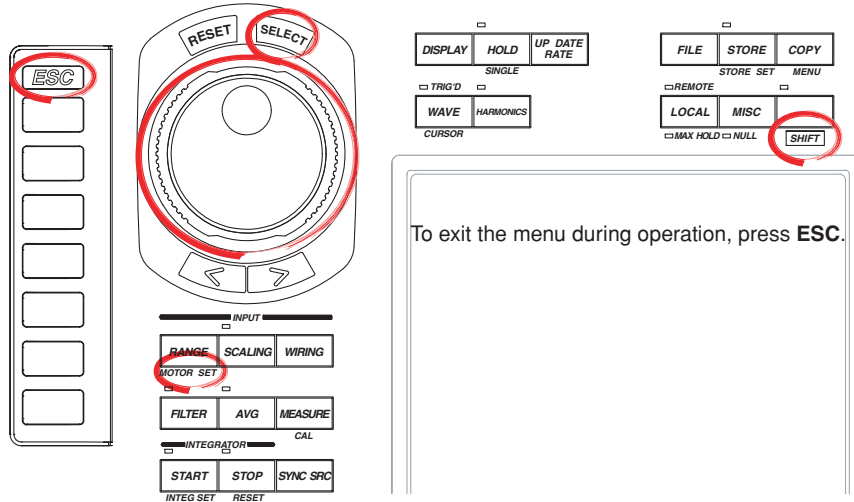

### Procedure

1. Press **SHIFT+RANGE (MOTOR SET)** to display the Motor Set dialog box.

#### Selecting the Input Range of the Revolution Signal

- When Analog is selected in the latter section “Selecting the revolution signal type”
2. Turn the **jog shuttle** to select Range under Speed.
  3. Press **SELECT** to display the input range selection box.
  4. Turn the **jog shuttle** to select the input range from Auto and 20 V to 1 V.
  5. Press **SELECT** to confirm the new input range.

Input range is selectable when the type of revolution signal is “Analog.”

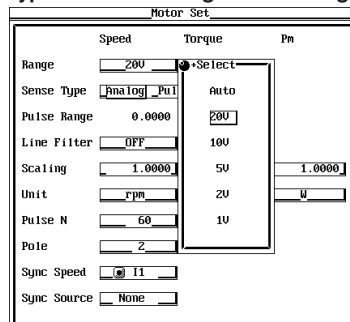

## 8.2 Selecting the Input Range of the Revolution and Torque Signals and the Synchronization Source

### Selecting the Input Range of the Torque Signal

2. Turn the **jog shuttle** to select Range under Torque.
3. Press **SELECT** to display the input range selection box.
4. Turn the **jog shuttle** to select the input range from Auto and 20 V to 1 V.
5. Press **SELECT** to confirm the new input range.

### Selecting the Revolution Signal Type

2. Turn the **jog shuttle** to select Sense Type.
3. Press **SELECT** to select Analog or Pulse.

### Setting the Pulse Input Range

(When the type of revolution signal is Pulse, set the pulse input range (rated value of the rotating speed). For D/A output (see section 15.1), the D/A output value is +5 V when the rotating speed is equal to the rated value.)

2. Turn the **jog shuttle** to select Pulse Range.
3. Press **SELECT** to display the pulse input range selection box.
4. Turn the **jog shuttle** to set the pulse input range.

For the procedures on how to enter values using the jog shuttle, see section 3.12, "Entering Values and Strings."

5. Press **SELECT** or **ESC** to close the box.

### Selecting the Synchronization Source

2. Turn the **jog shuttle** to select Sync Source.
3. Press **SELECT** to display the synchronization signal selection box.
4. Turn the **jog shuttle** to select any of the signals starting with U1.
5. Press **SELECT** to confirm the new synchronization source.

### Explanation

Signals from revolution sensors and torque meters can be input to the revolution signal input connector (SPEED) and the torque signal input connector (TORQUE) of the WT1600 for making measurements. For revolution sensors, the signal is a DC voltage (analog signal) or a pulse count that is proportional to the rotating speed of the motor. For torque meters, it is a DC voltage (analog signal) that is proportional to the motor's torque.

#### Selecting the Revolution Signal Type

You can select from the following list of choices.

- **Analog**  
Select this when the revolution signal type is a DC voltage (analog signal).
- **Pulse**  
Select this when the revolution signal type is a pulse signal.

#### Selecting the Input Range of the Revolution and Torque Signals

Two types of range settings are available: fixed range and auto range.

- **Fixed range**  
Select from the following input ranges.  
20 V, 10 V, 5 V, 2 V, and 1 V
- **Auto range**  
Select Auto for the input range setting to enable auto range. The range changes automatically depending on the amplitude of the input signal. The switching conditions and precautions are the same as the descriptions given in section 5.2, "Setting the Measurement Range during Direct Input." The different ranges used in the auto mode are the same as those available for fixed range.

#### Pulse Input Range

- When the type of revolution signal is Pulse, set the value of the rotating speed (rated value of the rotating speed) that will cause a D/A output (see section 15.1) of +5 V.
- Set the pulse count in the range from 0.0001 to 99999.9999.
- When the type of revolution signal is Pulse, the lower limit of the waveform display is fixed to 0, and the upper limit is the value equal to 1.2 times the rated value specified here.

#### Selecting the Synchronization Source

- Select which element's input signal will be used as a synchronization source (synchronized to the zero crossing point of the selected signal) when measuring the analog signal of the revolution signal and torque signal. Select the signal to be the synchronization source from the following list of choices. The selectable items vary depending on the installed elements.  
U1, I1, U2, I2, U3, I3, U4, I4, U5, I5, U6, I6, Ext Clk (external clock)\*, and None  
\* For the specifications of the Ext Clk (external clock), see the explanation in section 7.4.
- The measurement period determined by the synchronization source selected here is used to measure the analog signal of the revolution signal and torque signal. If you specify no synchronization source by selecting "None," the entire sampled data within the data update interval is the data used to determine the rotating speed and torque.
- This does not apply when the revolution signal is a pulse signal.
- When the revolution signal is a pulse signal, the measured value of the revolution signal is the averaged interval of the pulse signal of the measurement period determined from the synchronized source selected here. If the period of the pulse signal is not included in this measurement interval, the measured value is determined from the previous period.

## 8.3 Selecting the Line Filter

### Keys

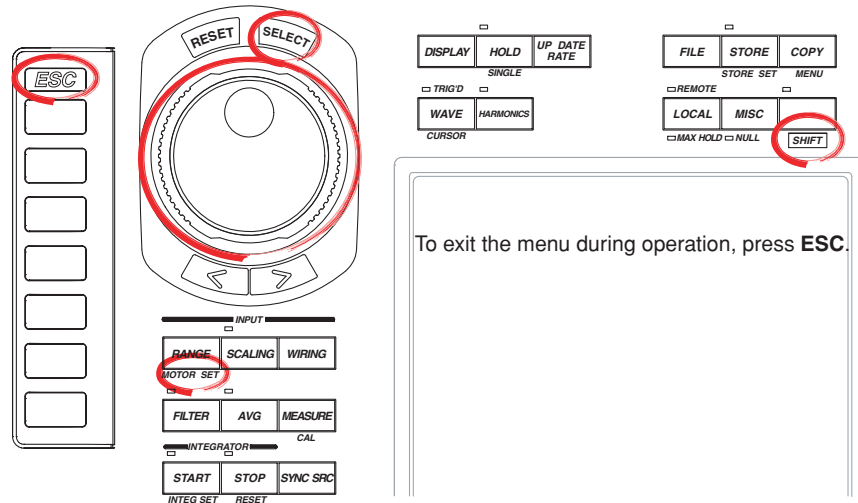

### Procedure

1. Press **SHIFT+RANGE (MOTOR SET)** to display the Motor Set dialog box.
2. Turn the **jog shuttle** to select Line Filter.
3. Press **SELECT** to display the line filter selection box.
4. Turn the **jog shuttle** to select OFF or 100 Hz.
5. Press **SELECT** to confirm the new line filter. The same filter is set to both the revolution signal and the torque signal.

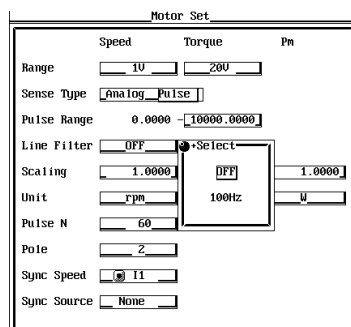

### Explanation

A line filter can be inserted into the circuits that measure the revolution signal and torque signal. It eliminates harmonic noise.

- The cutoff frequency can be selected from the list of choices below.  
OFF and 100 Hz
- Selecting OFF disables the filter.

### Note

When the revolution signal type is Pulse, the line filter does not function.

## 8.4 Setting the Scaling Factor, the Pulse Count, and Unit Used to Measure the Rotating Speed

### Keys

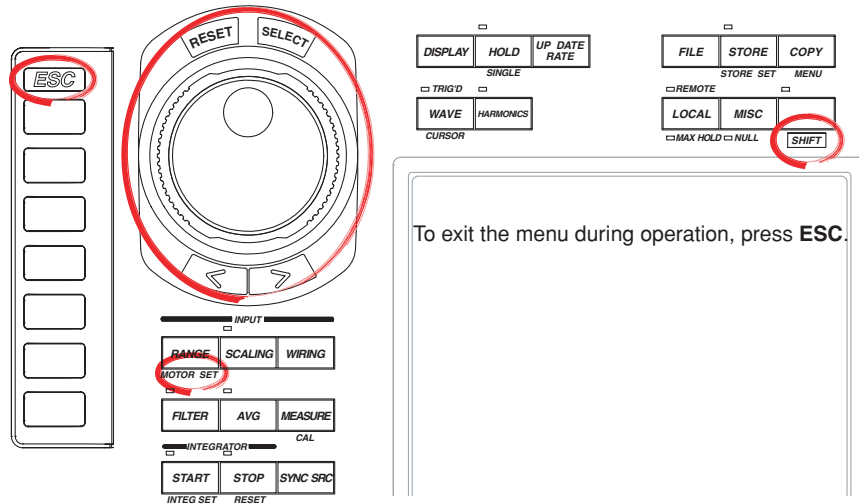

### Procedure

1. Press **SHIFT+RANGE (MOTOR SET)** to display the Motor Set dialog box.

#### Setting the Scaling Factor Used to Transform the Revolution Signal

2. Turn the **jog shuttle** to select Scaling under Speed.
3. Press **SELECT** to display the scaling factor setting box.
4. Turn the **jog shuttle** to set the scaling factor.  
For the procedures on how to enter values using the jog shuttle, see section 3.12, "Entering Values and Strings."
5. Press **SELECT** or **ESC** to close the box.

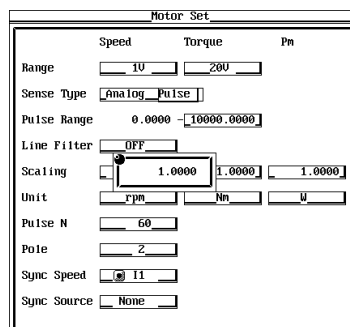

## 8.4 Setting the Scaling Factor, the Pulse Count, and Unit Used to Measure the Rotating Speed

### Setting the Pulse Count per Rotation When the Revolution Signal type Is Set to Pulse

2. Turn the **jog shuttle** to select Pulse N.
3. Press **SELECT** to display the pulse count setting box.
4. Turn the **jog shuttle** to set the pulse count.

For the procedures on how to enter values using the jog shuttle, see section 3.12, "Entering Values and Strings."

5. Press **SELECT** or **ESC** to close the box.

The screenshot shows the 'Motor Set' menu with the following settings:

- Speed: 10, Torque: 200
- Sense Type: Analog Pulse
- Pulse Range: 0.0000 - 10000.0000
- Line Filter: OFF
- Scaling: 1.0000, 1.0000, 1.0000
- Unit: rpm, Nm, U
- Pulse N: 60
- Pole: 2
- Sync Speed: 11
- Sync Source: None

### Setting the Unit of Rotating Speed

2. Turn the **jog shuttle** to select Unit under Speed.
3. Press **SELECT** to display the keyboard.
4. Use the **keyboard** to set the unit.

For keyboard operations, see section 3.12, "Entering Values and Strings."

The screenshot shows the 'Motor Set' menu with a keyboard overlay. The 'Unit' field is highlighted, and the keyboard shows the 'r', 'p', and 'm' keys being pressed to set the unit to 'rpm'. The other settings are the same as in the previous screenshot.

**Explanation**

**Setting the Scaling Factor**

Set the factor used to transform the revolution signal. Set the factor in the range from 0.0001 to 99999.9999.

- **When the revolution signal type is Analog**

By setting the number of rotations per volt of input voltage, the rotating speed is derived from the following equation.

$$\begin{aligned} \text{Speed (rotating speed)} \\ = \text{Input voltage from the revolution sensor} \times \text{Scaling factor} \end{aligned}$$

- **When the revolution signal type is Pulse**

The value is used as a scaling factor in the equation given in the next item "Setting the pulse count."

**Setting the Pulse Count**

Set the pulse count per rotation. Set the factor in the range from 1 to 9999. The scaling factor takes effect when the revolution signal type is set to Pulse in section 8.2.

$$\text{Speed (rotating speed)} = \frac{\text{Number of input pulses from the revolution sensor per minute}}{\text{Pulse count (pulse count per revolution)}} \times \text{Scaling factor}^*$$

\* When the scaling factor is 1, the rotating speed is equal to the number of rotations per minute ( $\text{min}^{-1}$  or rpm). When the revolution signal is a changed signal, you can set the scaling factor (see previous item) to determine the rotating speed before the change.

**Setting the Unit of Rotating Speed**

- Number of Characters  
Eight characters or less.
- Types of characters  
Characters that are displayed on the keyboard or spaces.

## 8.5 Setting the Scaling Factor and Unit Used to Measure the Torque

### Keys

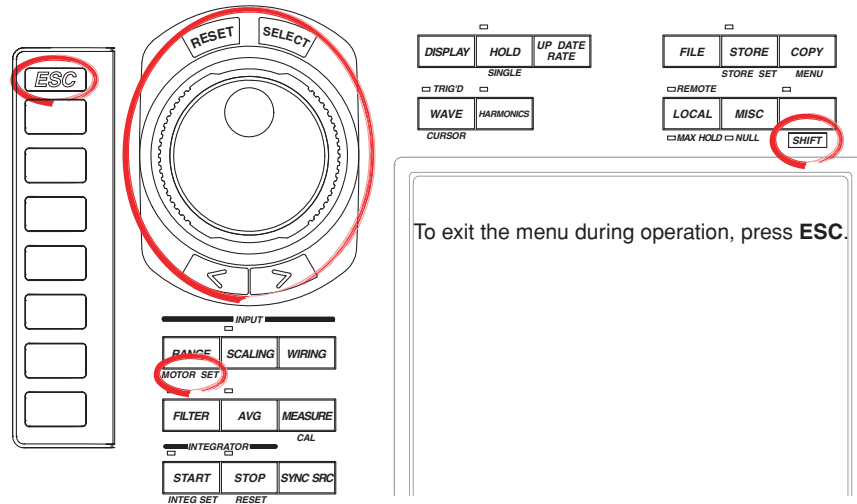

### Procedure

1. Press **SHIFT+RANGE (MOTOR SET)** to display the Motor Set dialog box.

#### Setting the Scaling Factor Used to Transform the Torque Signal

2. Turn the **jog shuttle** to select Scaling under Torque.
3. Press **SELECT** to display the scaling factor setting box.
4. Turn the **jog shuttle** to set the scaling factor.  
For the procedures on how to enter values using the jog shuttle, see section 3.12, "Entering Values and Strings."
5. Press **SELECT** or **ESC** to close the box.

Motor Set		
Speed	Torque	Pn
Range	<input type="text" value="10"/>	<input type="text" value="200"/>
Sense Type	<input type="text" value="Analog Pulse"/>	
Pulse Range	<input type="text" value="0.0000 - 10000.0000"/>	
Line Filter	<input type="text" value="OFF"/>	
Scaling	<input type="text" value="1.0000"/>	<input type="text" value="1.0000"/>
Unit	<input type="text" value="rpm"/>	<input type="text" value="Nm"/>
Pulse N	<input type="text" value="60"/>	
Pole	<input type="text" value="2"/>	
Sync Speed	<input checked="" type="checkbox"/> 11	
Sync Source	<input type="text" value="None"/>	



**Setting the Unit of Torque**

2. Turn the **jog shuttle** to select Torque under Unit.
3. Press **SELECT** to display the keyboard.
4. Use the **keyboard** to set the unit.

For keyboard operations, see section 3.12, “Entering Values and Strings.”

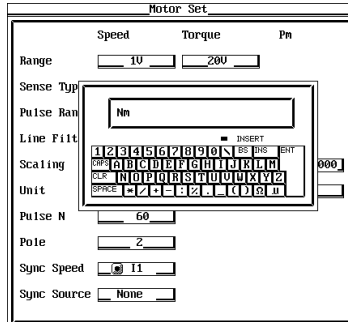

**Explanation**

**Setting the Scaling Factor**

You can specify the scaling factor used to transform the torque signal to the torque of the motor. Set the factor in the range from 0.0001 to 99999.9999.

By setting the torque per volt of input voltage, the torque is derived from the input voltage from the torque meter using the following equation.

$$\text{Torque} = \text{Input voltage from the torque meter} \times \text{Scaling factor}$$

**Setting the Unit of Torque**

- Number of Characters  
Eight characters or less.
- Types of characters  
Characters that are displayed on the keyboard or spaces.

**Note**

To set the unit of the motor output that is determined in section 8.7 to “W,” set the unit of torque to N·m.

## 8.6 Setting the Motor's Number of Poles Used to Compute the Synchronous Speed and the Slip

### Keys

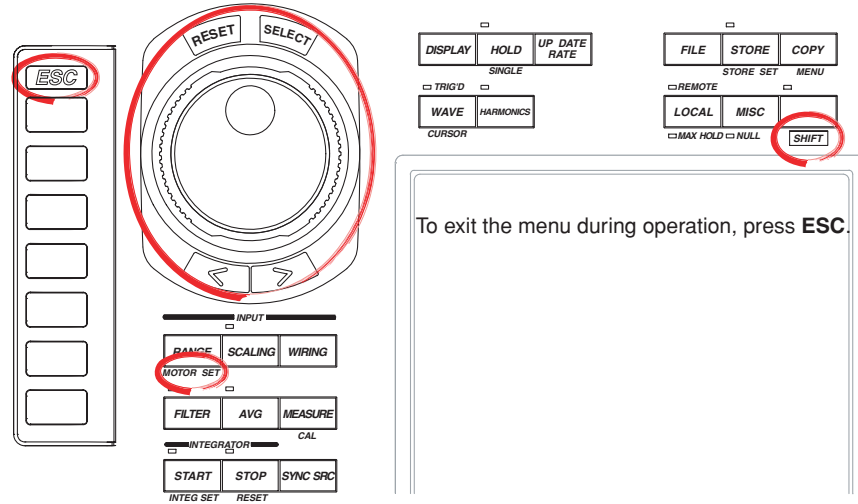

### Procedure

1. Press **SHIFT+RANGE (MOTOR SET)** to display the Motor Set dialog box.

#### Setting the Motor's Number of Poles

2. Turn the **jog shuttle** to select Pole.
3. Press **SELECT** to display the motor's number of poles selection box.
4. Turn the **jog shuttle** to set the number of poles.  
For the procedures on how to enter values using the jog shuttle, see section 3.12, "Entering Values and Strings."
5. Press **SELECT** or **ESC** to close the box.

Motor Set		
Speed	Torque	Pn
Range	<input type="text" value="1V"/>	<input type="text" value="200"/>
Sense Type	<input type="text" value="Analog Pulse"/>	
Pulse Range	<input type="text" value="0.0000"/> - <input type="text" value="10000.0000"/>	
Line Filter	<input type="text" value="OFF"/>	
Scaling	<input type="text" value="1.0000"/>	<input type="text" value="1.0000"/> <input type="text" value="1.0000"/>
Unit	<input type="text" value="rpm"/>	<input type="text" value="Nm"/> <input type="text" value="W"/>
Pulse N	<input type="text" value="60"/>	
Pole	<input type="text" value="2"/>	
Sync Speed	<input type="text" value="11"/>	
Sync Source	<input type="text" value="None"/>	

## 8.6 Setting the Motor's Number of Poles Used to Compute the Synchronous Speed and the Slip

### Selecting the Frequency Measurement Source (Voltage or Current Supplied to the Motor)

2. Turn the **jog shuttle** to select Sync Speed.
3. Press **SELECT** to display the frequency measurement source selection box.
4. Turn the **jog shuttle** to select any of the target input signals for frequency measurement (see section 6.3).

When the button to the left of the input signal in the selection box is highlighted, that is the target input signal for frequency measurement selected in section 6.3.

5. Press **SELECT** to confirm the new frequency measurement source.

### Explanation

#### Setting the Motor's Number of Poles

The value can be set in the range of 1 to 99. Sets the number of poles for the motor being measured.

#### Setting the Frequency Measurement Source

- Select the frequency measurement source from the following list of choices. The selectable items vary depending on the installed elements.  
U1, I1, U2, I2, U3, I3, U4, I4, U5, I5, U6, and I6
- Select any of the target input signals for frequency measurement. When the button to the left of the input signal in the frequency measurement source selection box is highlighted, that is the target input signal for frequency measurement selected in section 6.3. If you select an input signal that is not a frequency measurement target, an error results.
- In normal cases, a voltage or current supplied to the motor of which the input signal is a frequency measurement target (see section 6.3) is selected. If a frequency other than that of the voltage and current supplied by the motor is specified, the synchronous speed may not be determined correctly.

#### Equation for Deriving the Synchronous Speed

The unit of synchronous speed is fixed to  $\text{min}^{-1}$  or rpm. The equation is shown below.

$$\text{Sync (min}^{-1}\text{)} = \frac{120 \times \text{Frequency of the frequency measurement source (Hz)}}{\text{Motor's number of poles}}$$

#### Equation for Deriving the Slip

The unit of synchronous speed is fixed to  $\text{min}^{-1}$  (or rpm). Therefore, to determine the slip, set the scaling factor (see section 8.4) of the rotating speed so that the unit of rotating speed is also  $\text{min}^{-1}$  (or rpm).

$$\text{Slip (\%)} = \frac{\text{Synchronous speed (min}^{-1}\text{)} - \text{Rotating speed}^* \text{ (min}^{-1}\text{)}}{\text{Synchronous speed (min}^{-1}\text{)}} \times 100$$

\* Rotating speed derived in section 8.4.

#### Note

Please select a stable voltage or current (supplied by the motor) with small distortion or noise for the frequency measurement source.

## 8.7 Setting the Scaling Factor and Unit Used to Compute the Motor Output

### Keys

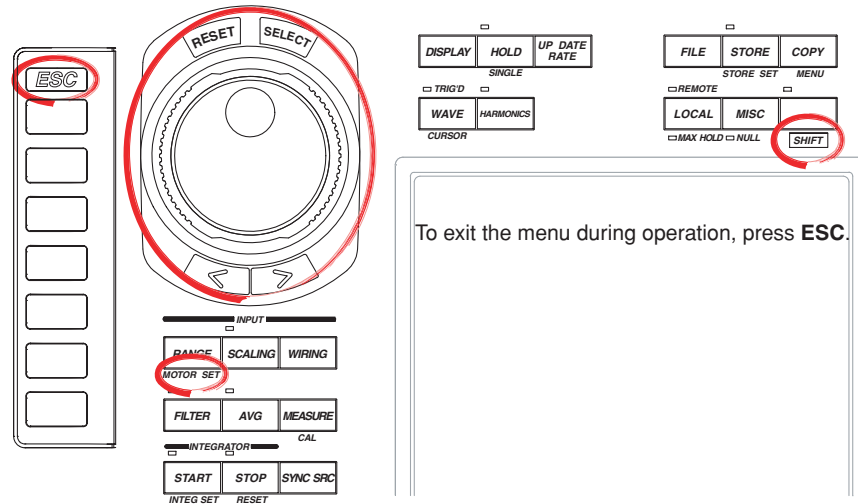

### Procedure

1. Press **SHIFT+RANGE (MOTOR SET)** to display the Motor Set dialog box.

#### Setting the Scaling Factor Used to Compute the Motor Output

2. Turn the **jog shuttle** to select Scaling under Pm.
3. Press **SELECT** to display the scaling factor setting box.
4. Turn the **jog shuttle** to set the scaling factor.

For the procedures on how to enter values using the jog shuttle, see section 3.12, "Entering Values and Strings."

5. Press **SELECT** or **ESC** to close the box.

Motor Set		
Speed	Torque	Pm
Range	<input type="text" value="10"/>	<input type="text" value="200"/>
Sense Type	<input type="text" value="Analog Pulse"/>	
Pulse Range	<input type="text" value="0.0000 - 10000.0000"/>	
Line Filter	<input type="text" value="OFF"/>	
Scaling	<input type="text" value="1.0000"/>	<input type="text" value="1.0000"/>
Unit	<input type="text" value="rpm"/>	<input type="text" value="Nm"/>
Pulse N	<input type="text" value="60"/>	
Pole	<input type="text" value="2"/>	
Sync Speed	<input checked="" type="checkbox"/> <input type="checkbox"/> <input type="text" value="11"/>	
Sync Source	<input type="text" value="None"/>	

**Setting the Unit of Motor Output**

2. Turn the **jog shuttle** to select Unit under Pm.
3. Press **SELECT** to display the keyboard.
4. Use the **keyboard** to set the unit.

For keyboard operations, see section 3.12, “Entering Values and Strings.”

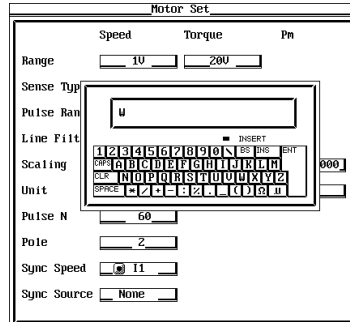

**Explanation**

**Setting the Scaling Factor**

You can specify the scaling factor used to compute the motor output (mechanical power) from the rotating speed and torque. Set the factor in the range from 0.0001 to 99999.9999.

The equation is indicated below. When the scaling factors of rotating speed and torque (see section 8.4 and 8.5) are set so that the unit of rotating speed is min<sup>-1</sup> (or rpm) and the unit of torque is N·m and the scaling factor of the motor output specified here is 1, the unit of motor output Pm becomes W. In the computation of efficiency in section 8.8, the computation is carried out by taking the unit of Pm to be W. Therefore, it is recommended that the scaling factors of the items be set so that the unit of Pm becomes W.

$$\text{Motor output } P_m = \frac{2 \times \pi \times \text{Rotating speed}^{*1}}{60} \times \text{Scaling factor} \times \text{Torque}^{*2}$$

\*1 Rotating speed derived in section 8.4.

\*2 Torque derived in section 8.5.

**Note**

For products with ROM version 1.05 or earlier, the equation for Pm is as follows:

$$P_m = \text{Rotating speed} \times \text{Scaling factor} \times \text{Torque}$$

**Setting the Unit of Motor Output**

- Number of Characters  
Eight characters or less.
- Types of characters  
Characters that are displayed on the keyboard or spaces.

## 8.8 Computing the Motor Efficiency and Total Efficiency

From the active power measured by the WT1600 and the motor output determined in section 8.7, the WT1600 can compute the motor efficiency (ratio of the motor output versus the power consumption by the motor) and total efficiency (ratio of the motor output versus the power consumption by the motor as well as the converter through which power is fed to the motor). Computation examples are indicated below.

### When the Motor Input Is Wired to $\Sigma A$

$\eta_{mA}$  is the motor efficiency.

$$\text{Motor efficiency } \eta_{mA}(\%) = \frac{\text{Motor output}^* (\text{W})}{\Sigma A(\text{W})} \times 100$$

\* Motor output derived in section 8.7.

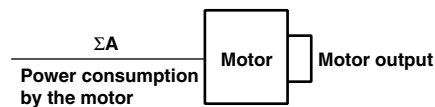

### When the Converter Input Is Wired to $\Sigma A$ and Motor Input Is Wired to $\Sigma B$

$\eta_{mB}$  and  $\eta_{mA}$  are the total efficiency and motor efficiency, respectively.

$$\text{Motor efficiency } \eta_{mB}(\%) = \frac{\text{Motor output}^* (\text{W})}{\Sigma B(\text{W})} \times 100$$

$$\text{Total efficiency } \eta_{mA}(\%) = \frac{\text{Motor output}^* (\text{W})}{\Sigma A(\text{W})} \times 100$$

\* Motor output derived in section 8.7.

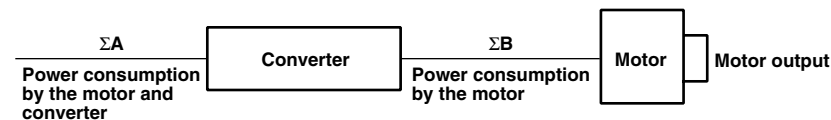

### When the Converter Input Is Wired to $\Sigma B$ and Motor Input Is Wired to $\Sigma A$

$\eta_{mA}$  and  $\eta_{mB}$  are the motor efficiency and total efficiency, respectively.

$$\text{Motor efficiency } \eta_{mA}(\%) = \frac{\text{Motor output}^* (\text{W})}{\Sigma A(\text{W})} \times 100$$

$$\text{Total efficiency } \eta_{mB}(\%) = \frac{\text{Motor output}^* (\text{W})}{\Sigma B(\text{W})} \times 100$$

\* Motor output derived in section 8.7.

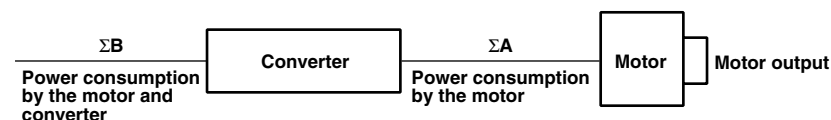

#### Note

With this wiring system, the delta computation function (see section 6.5) can be used to carry out 3P3W>3V3A transformation. From the 3P3W>3V3A transformation, you can determine one set of line voltage and common mode current that is not being measured.

# 9.1 Retrieving Waveform Display Data

«For a functional description, see section 1.7.»

### Keys

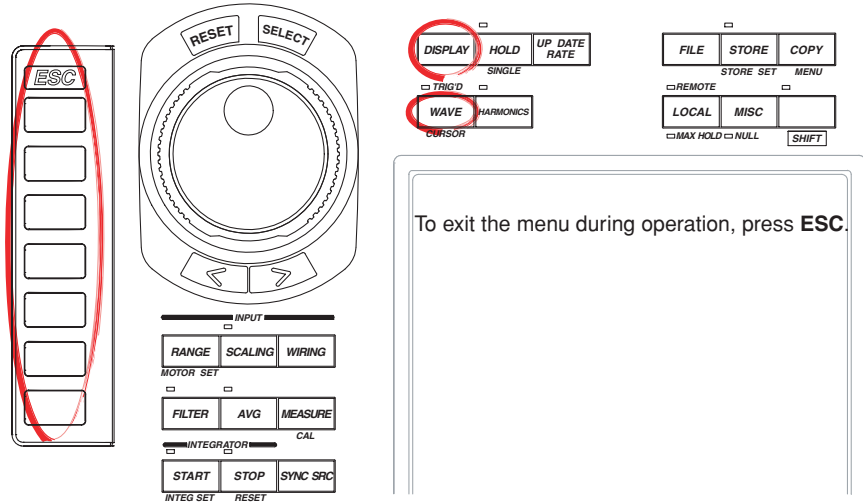

### Procedure

1. Press **DISPLAY** to display the Display menu. Check that Format (display format) is set to Wave, Numeric+Wave, Wave+Bar, or Wave+Trend. For details on setting the display format, see section 4.2.
2. Press **WAVE** to display the Wave menu.
3. Press the **Wave Sampling** soft key to select ON or OFF. When turned ON, retrieval of waveform display data is started according to the trigger setting (see section 9.3).

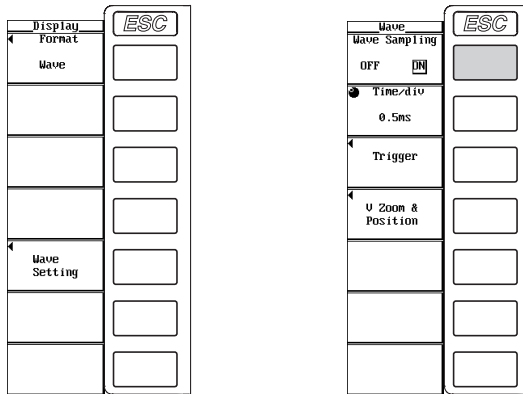

### Explanation

The retrieval of waveform display data must be turned ON to display waveforms. The sample data that was acquired within the data update rate is P-P compressed and stored to the memory as waveform display data.

- ON  
The retrieval of waveform display data starts according to the trigger settings (see section 9.3).
- OFF  
Waveform display data is not retrieved.

## 9.2 Setting the Time Axis

«For a functional description, see section 1.7.»

### Keys

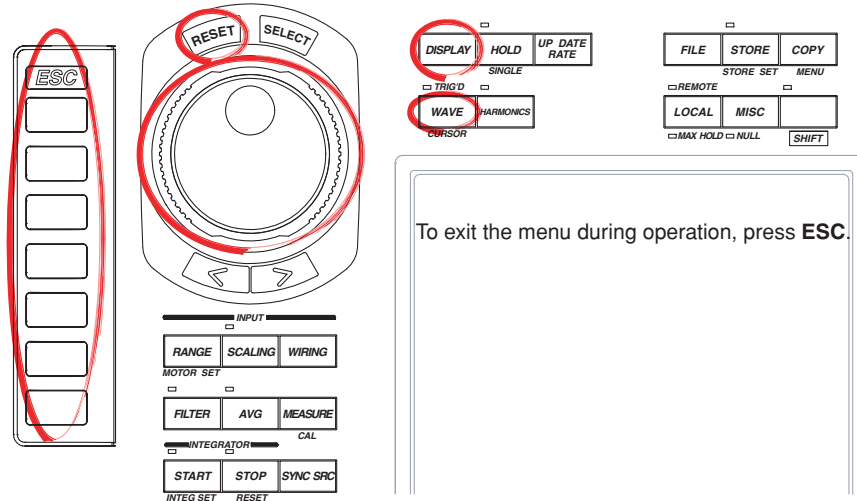

### Procedure

- Check that the measurement mode is set to normal measurement. If the measurement mode is set to harmonic measurement, Set Mode to OFF in the Harmonics menu (see section 7.1).
  - The retrieval of waveform display data must be turned ON to display waveforms. For the procedure, see section 9.1.
1. Press **DISPLAY** to display the Display menu. Check that Format (display format) is set to Wave, Numeric+Wave, or Wave+Trend. For details on setting the display format, see section 4.2.
  2. Press **WAVE** to display the Wave menu.
  3. Turn the **jog shuttle** to set the time axis. When the display of scale values is turned ON (see section 9.8), the time at the left end (fixed to 0 s) and the right end of the screen are displayed at the lower left corner and lower right corner of the screen, respectively.

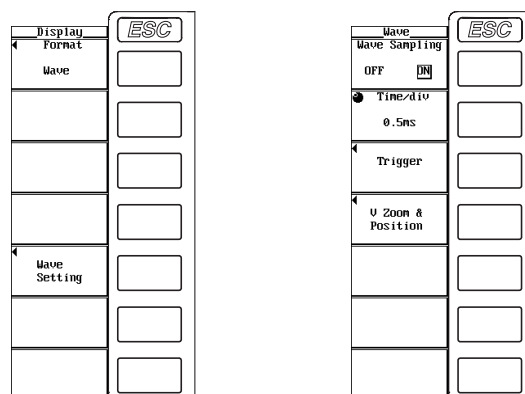



**Explanation**

**During Normal Measurement**

Set the time axis in terms of Time/div (time per grid).

The time axis can be set in 1, 2, or 5 steps in the range up to the point in which the time corresponding to one screen is equal to the data update rate. If the data update rate is 500 ms, for example, changing the time per division in the order 0.5 ms, 1 ms, 2 ms, 5 ms, 10 ms, 20 ms, and 50 ms changes the time corresponding to one screen in the order 5 ms, 10 ms, 50 ms, 100 ms, 200 ms, and 500 ms.

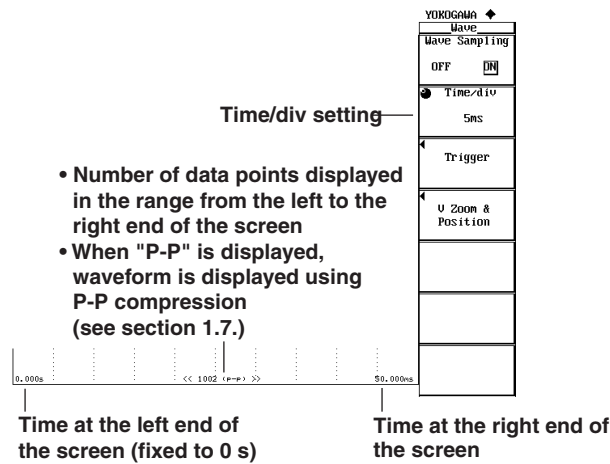

**During Harmonic Measurement**

The time corresponding to one screen in harmonic measurement is automatically determined from the sample rate, which can be derived from the fundamental frequency of the PLL source (see section 7.4), and the data length (Time width over which FFT analysis is performed when determining harmonics, see section 7.7). It cannot be set arbitrarily.

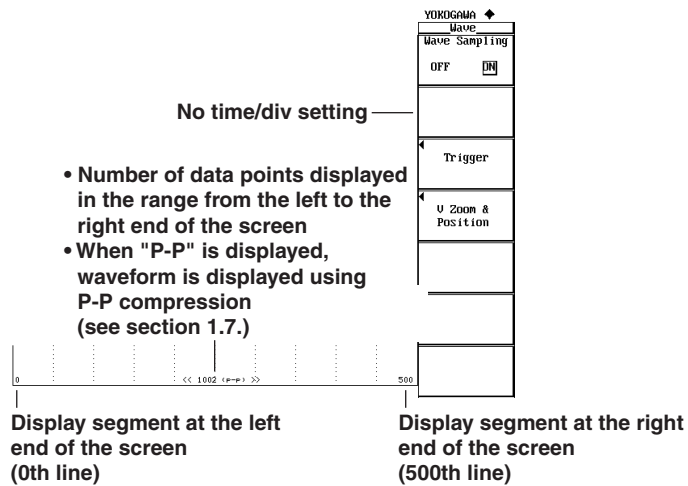

## 9.3 Setting the Trigger

«For a functional description, see section 1.7.»

### Keys

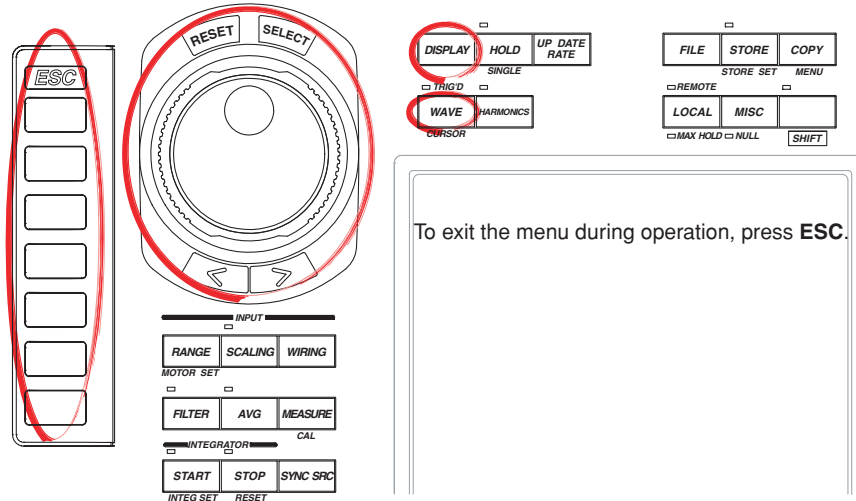

To exit the menu during operation, press **ESC**.

### Procedure

The retrieval of waveform display data must be turned ON to display waveforms. For the procedure, see section 9.1.

1. Press **DISPLAY** to display the Display menu.  
Check that Format (display format) is set to Wave, Numeric+Wave, Wave+Bar, or Wave+Trend. For details on setting the display format, see section 4.2.
2. Press **WAVE** to display the Wave menu.
3. Press the **Trigger** soft key to display the Trigger menu.

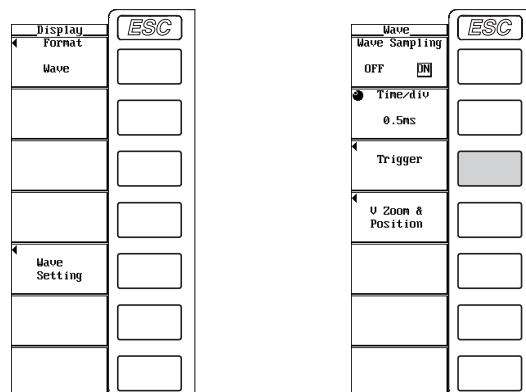

**Selecting the Trigger Mode**

4. Press the **Mode** soft key to display the Mode menu.
5. Press the **Auto** or **Normal** soft key to select the trigger mode.

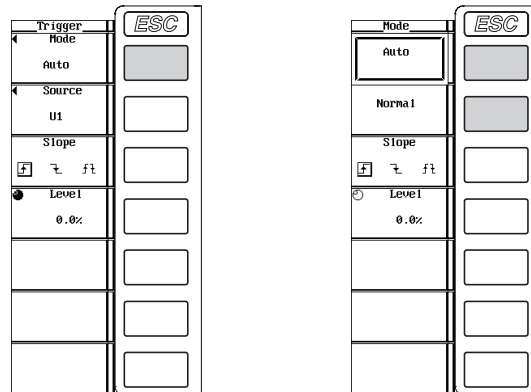

**Selecting the Trigger Source**

4. Press the **Source** soft key to display the trigger source selection box.
5. Turn the **jog shuttle** to select any of the signals starting with U1.
6. Press **SELECT** to confirm the new trigger source.

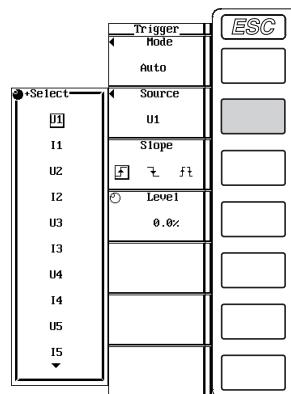

**Selecting the Trigger Slope**

4. Press the **Slope** soft key to select  $f$ ,  $\downarrow$ , or  $f\downarrow$ .

**Setting the Trigger Level**

4. Turn the **jog shuttle** to set the trigger level.  
For the procedures on how to enter values using the jog shuttle, see section 3.12, "Entering Values and Strings."

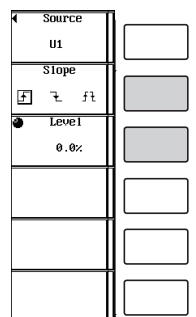

### Explanation

Trigger is a cue used to display the waveform on the screen. The trigger is activated when the specified trigger condition is met. At this point, the waveform is ready to be displayed on the screen.

#### Selecting the Trigger Mode

Trigger mode specifies the conditions for updating the screen display. You can select from the following list of choices.

- Auto  
Enables auto mode.
  - If a trigger occurs (TRIG'D indicator illuminates) within the timeout time (approx. 100 ms), the display is updated using that trigger.
  - If a trigger does not occur within the timeout time, the display is automatically updated (TRIG'D indicator not illuminated) when the timeout time elapses.
  - When the trigger signal period is greater than or equal to 100 ms, the two conditions above are met alternately and the display is updated. In such case, use normal mode.
- Normal  
Enables normal mode.
  - The display is updated when the trigger occurs.
  - The display is not updated if the trigger does not occur.

#### Selecting the Trigger Source

Select the target for the specified trigger condition (trigger source) from the following list of choices. The selectable items vary depending on the installed elements.

U1, I1, U2, I2, U3, I3, U4, I4, U5, I5, U6, I6, and Ext Clk (external clock)\*

- \* If the trigger source is set to Ext Clk, apply a signal according to the following specifications. If the trigger source is set to Ext Clk, the trigger level settings are void.

#### When Setting the Trigger Source to Ext Clk

Apply a trigger signal to the external clock input connector (EXT CLK) on the rear panel according to the following specifications.



Item	Specification
Connector type	BNC connector
Input level	TTL
Minimum pulse width	1 $\mu$ s
Trigger delay time	Within (1 $\mu$ s + 1 sample period)



### CAUTION

Applying a voltage outside the range of 0 to 5 V to the external clock input connector (EXT CLK) can damage the instrument.

### Input Circuit for the External Trigger Signal and Time Chart

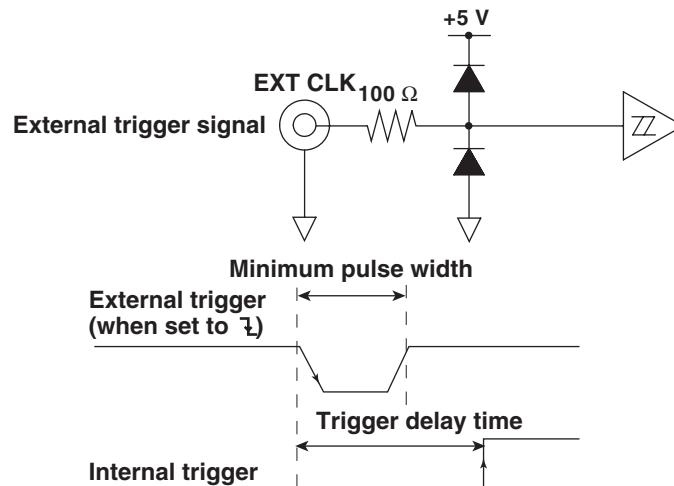

#### Selecting the Trigger Slope

The up and down movement of a signal level is called a slope. When the slope is used as one of the trigger conditions, it is called a trigger slope. You can select the trigger slope from the following list of choices.

- $\uparrow$  : The trigger occurs when the trigger source signal rises above the trigger level from a lower level.
- $\downarrow$  : The trigger occurs when the trigger source signal falls below the trigger level from a higher level.
- $\uparrow\downarrow$  : Trigger occurs on both the rising and falling cases.

#### Setting the Trigger Level

Trigger level refers to the level through which the trigger slope passes. When the slope of the trigger source passes through the specified trigger level on a rising or falling edge, a trigger occurs.

- The level can be set in the range from 0.0 to  $\pm 100.0\%$ .
- Half of the total vertical span of the waveform display screen is considered to be 100%. With the vertical center of the screen taken to be the input zero line, the upper and lower limits of the waveform display screen are 100% and  $-100\%$ , respectively. If the crest factor is set to 3, the upper and lower limits of the waveform display screen correspond to three times the measurement range (if scaled, the range after scaling) of the voltage/current that is set for each element. Likewise, if the crest factor is set to 6, the upper and lower limits correspond to six times the measurement range.
- The trigger level setting is void when the trigger source is set to Ext Clk.

Measurement range: 100 Vrms when the crest factor is 3, 50 Vrms when the crest factor is 6  
Trigger level: 25%

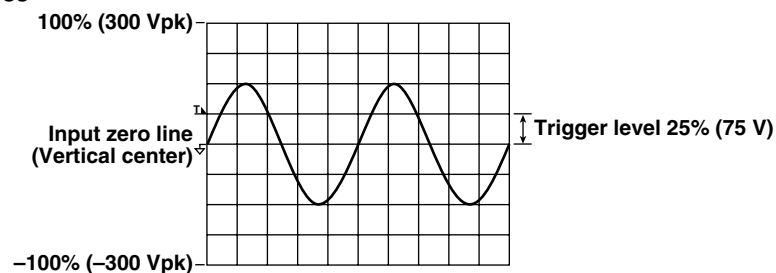

#### Note

To prevent erroneous operation caused by noise, the trigger function uses approximately 2% hysteresis if the crest factor is set to 3. If the trigger slope is set to  $\downarrow$ , for example, the trigger does not occur until the input signal level falls approximately 2% below the trigger level. The trigger function uses approximately 4% hysteresis if the crest factor is set to 6.

# 9.4 Zooming Vertically and Moving the Vertical Position

«For a functional description, see section 1.7.»

## Keys

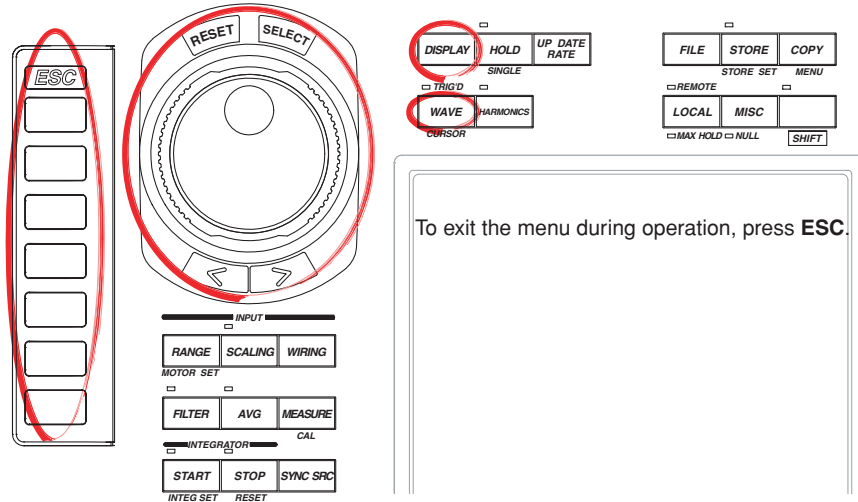

## Procedure

The retrieval of waveform display data must be turned ON to display waveforms. For the procedure, see section 9.1.

1. Press **DISPLAY** to display the Display menu.  
Check that Format (display format) is set to Wave, Numeric+Wave, Wave+Bar, or Wave+Trend. For details on setting the display format, see section 4.2.
2. Press **WAVE** to display the Wave menu.
3. Press the **V Zoom & Position** soft key to display the V Zoom & Pos menu.

### Selecting the Target Element

4. Press the **Element Object** soft key to display the Element menu.  
Only the installed elements are displayed.
5. Press one the soft keys corresponding to the displayed element to select the target element.

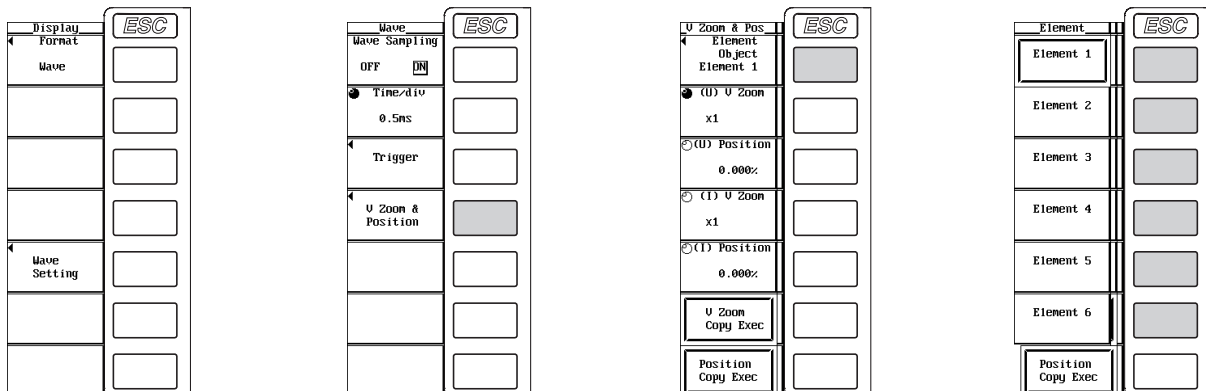

**Zooming in on the Voltage Waveform**

6. Press the **(U) V Zoom** soft key.
7. Turn the **jog shuttle** to set the zoom factor.

**Moving the Voltage Waveform Position**

6. Press the **(U) Position** soft key.
7. If the crest factor is set to 3 or 6, turn the **jog shuttle** to set the position in terms of a percentage with the value equal to measurement range  $\times$  3 or measurement range  $\times$  6, respectively, taken to be 100%.  
For the procedures on how to enter values using the jog shuttle, see section 3.12, "Entering Values and Strings."

**Zooming in on the Current Waveform**

6. Press the **(I) V Zoom** soft key.
7. Turn the **jog shuttle** to set the zoom factor.

**Moving the Current Waveform Position**

6. Press the **(I) Position** soft key.
7. If the crest factor is set to 3 or 6, turn the **jog shuttle** to set the position in terms of a percentage with the value equal to measurement range  $\times$  3 or measurement range  $\times$  6, respectively, taken to be 100%.  
For the procedures on how to enter values using the jog shuttle, see section 3.12, "Entering Values and Strings."

**Copying the Zoom Factor and Position**

The zoom factor and position specified for a given element can be set to the elements of the same wiring unit. The zoom factor and position for other elements that were specified before are not held.

6. Press one of the soft keys corresponding to the displayed element from which the information is to be copied (the copy source).
7. To copy the zoom factor, press the **V Zoom Copy Exec** soft key. To copy the position, press the **Position Copy Exec** soft key. The zoom factor and position of the voltage and current waveforms of the copy source are copied to the elements of the same wiring unit. However, if the wiring system is pattern 1, the settings are copied to all other elements.

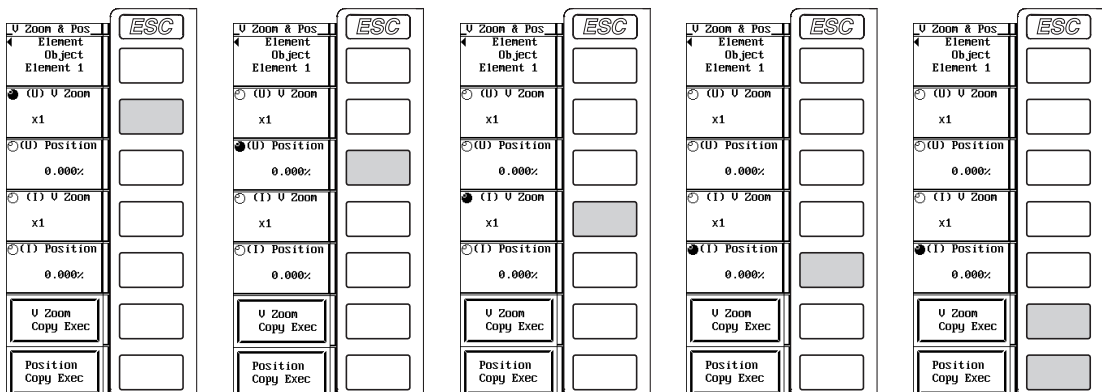

**Explanation**

**Selecting the Target Element to Be Specified**

Only the installed elements are displayed. The Element menu is displayed according to the element configuration of the product.

**Zoom (Vertical Direction Only)**

You can expand or reduce each displayed waveform (voltage/current). You can select the zoom factor from the following list of choices.

0.1, 0.2, 0.25, 0.4, 0.5, 0.75, 0.8, 1, 1.14, 1.25, 1.33, 1.41, 1.5, 1.6, 1.77, 2, 2.28, 2.66, 2.83, 3.2, 3.54, 4, 5, 8, 10, 12.5, 16, 20, 25, 40, 50, and 100

**Moving the Position (Vertical Direction Only)**

The displayed position of the waveform can be moved vertically to the desired position such as when you wish to view the mutual relationship between the voltage and current waveforms or when the section of the waveform you wish to view goes out of the display frame.

- The position can be set in the range from 0.000 to  $\pm 130.000\%$ .
- When the zoom factor is 1, half of the total vertical span of the waveform display screen (equal to measurement range  $\times 3$  or measurement range  $\times 6$  when the crest factor is set to 3 or 6, respectively) is considered to be 100%.

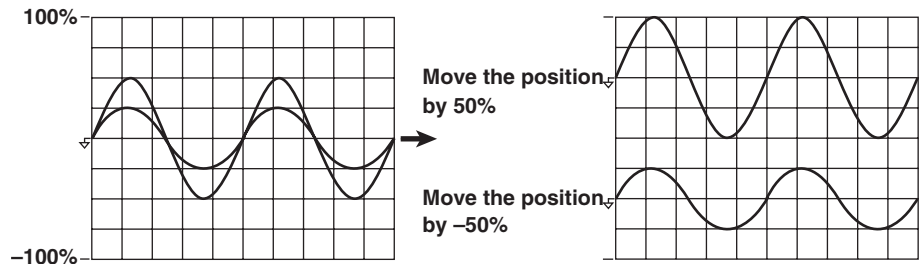

- When the zoom factor is not 1, the value equal to the measurement range  $\times 3$  (100%) or measurement range  $\times 6$  (100%) when the crest factor is set to 3 or 6, respectively, is not located at the upper and lower limits of the screen as shown in the following figure. Set the position by paying attention to the zoom factor. The following figure shows an example when the crest factor is set to 3.

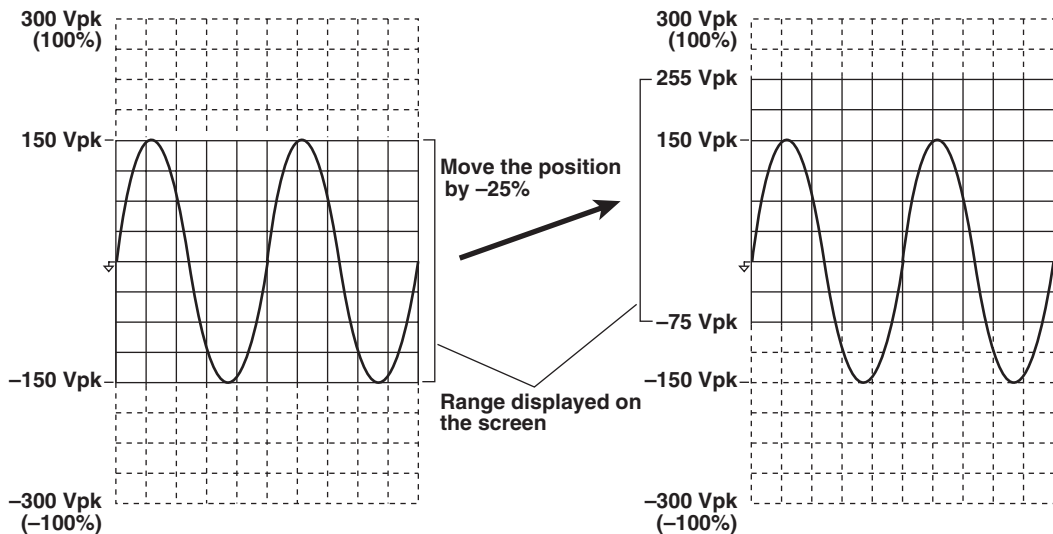

**Note**

To expand and view a section of the waveform, we recommend the following procedure.

1. Set the zoom factor to 1.
2. Move the vertical position so that the desired section of the waveform is at the center position (according to the procedure described in this section).
3. Set the vertical zoom factor.



## 9.5 Turning ON/OFF the Waveform Display

«For a functional description, see section 1.7.»

### Keys

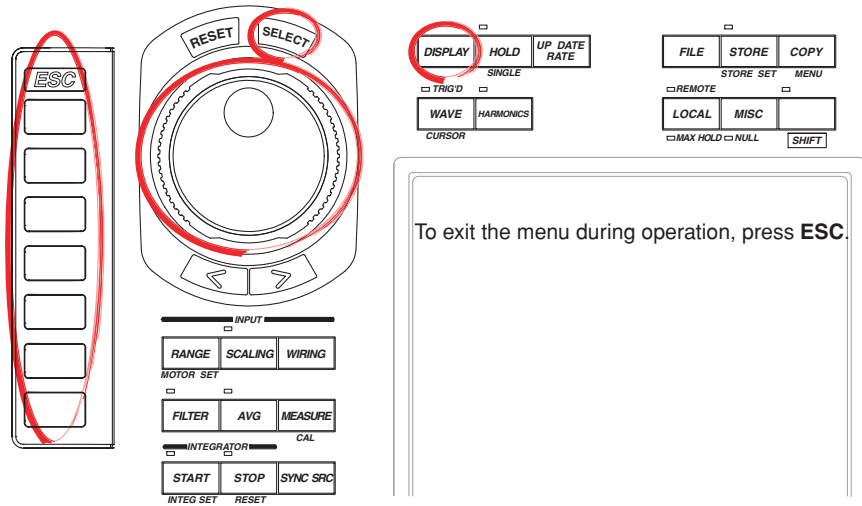

### Procedure

The retrieval of waveform display data must be turned ON to display waveforms. For the procedure, see section 9.1.

1. Press **DISPLAY** to display the Display menu. Check that Format (display format) is set to Wave, Numeric+Wave, Wave+Bar, or Wave+Trend. For details on setting the display format, see section 4.2.

The following procedures are given for a representative example in which the display format is set to Wave.

2. Press the **Wave Setting** soft key to display the Wave Setting menu.

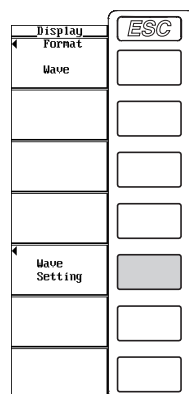

## 9.5 Turning ON/OFF the Waveform Display

- Press the **Wave Display** soft key to display the Wave Display dialog box.

### Turning ON/OFF the Display of the Input Signal Waveforms at Once

- **Turning ON the display of the waveforms at once**

- Turn the **jog shuttle** to select All ON.
- Press **SELECT**. All the buttons to the left of the input signal are highlighted. In addition, if the retrieval of the waveform display data (see section 9.1) is ON, the waveforms are displayed.

- **Turning OFF the display of the waveforms at once**

- Turn the **jog shuttle** to select All OFF.
- Press **SELECT**. The highlighting of all the buttons to the left of the signal is cleared and the waveforms are no longer displayed.

### Turning ON/OFF the Input Signal Waveforms One at a Time

- Turn the **jog shuttle** to select the input signal you wish to set.
- Press **SELECT**. If the retrieval of the waveform display data (see section 9.1) is ON and the button to the left of the selected input signal is highlighted, the waveform of that input signal is displayed. If the highlighting of the button is cleared, the waveform of that input signal is no longer displayed.

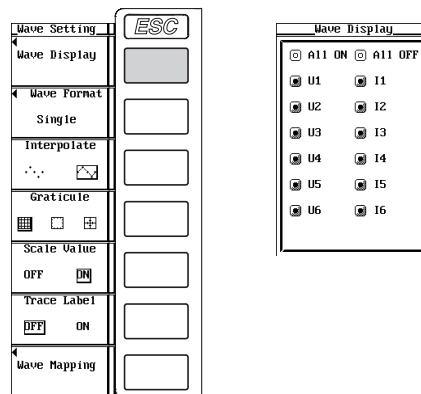

### Explanation

Only the input signals corresponding to the installed elements are displayed. The waveform display can be turned ON/OFF for those input signals. For models with the motor evaluation function (option), the waveform display for Speed and Torque input signals can be turned ON/OFF through this procedure.

## 9.6 Splitting the Screen and Displaying Waveforms

«For a functional description, see section 1.7.»

### Keys

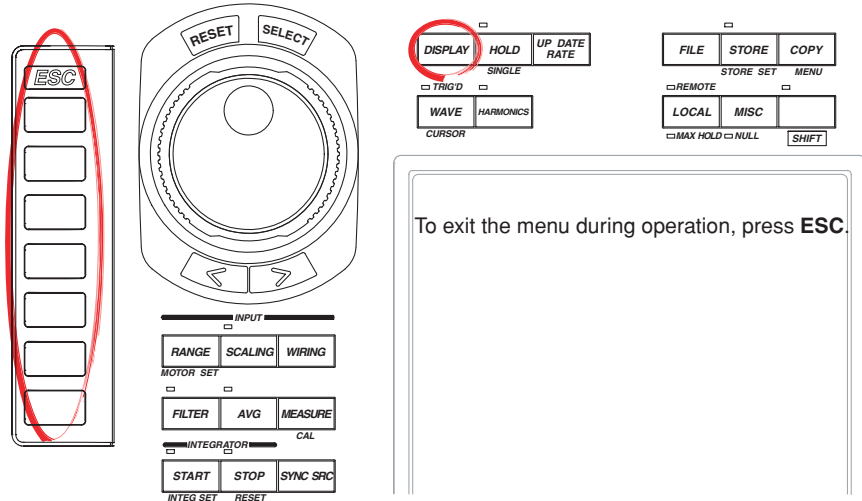

### Procedure

The retrieval of waveform display data must be turned ON to display waveforms. For the procedure, see section 9.1.

1. Press **DISPLAY** to display the Display menu.  
Check that Format (display format) is set to Wave, Numeric+Wave, Wave+Bar, or Wave+Trend. For details on setting the display format, see section 4.2.

The following procedures are given for a representative example in which the display format is set to Wave.

#### Selecting the Number of Split Windows

2. Press the **Wave Setting** soft key to display the Wave Setting menu.
3. Press the **Wave Format** soft key to display the Format menu.
4. Press one of the keys from **Single** to **Quad** to select the number of windows.

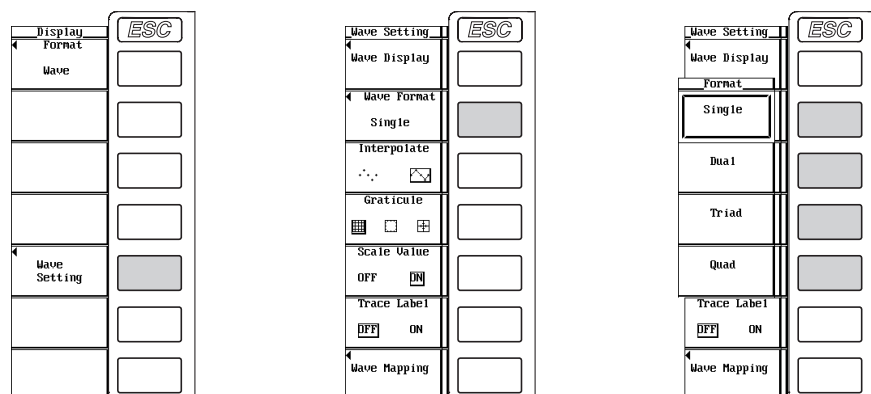

## 9.6 Splitting the Screen and Displaying Waveforms

### Selecting the Waveform Mapping

5. Press the **Wave Mapping** soft key to display the Wave Mapping dialog box.
6. Turn the **jog shuttle** to select Mode.
7. Press **SELECT** to select Auto, Fixed, or User. If you selected User, proceed to step 8.
8. Turn the **jog shuttle** to select the input signal you wish to set.
9. Press **SELECT** to display the display position number selection box.
10. Turn the **jog shuttle** to select 0 to 3.
11. Press **SELECT** to confirm the new display position.

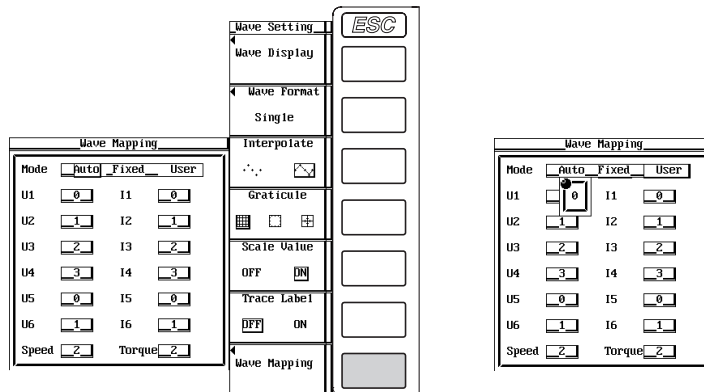

**Explanation**

The screen can be evenly divided and the waveforms can be mapped to the divided windows.

**Selecting the Number of Divisions**

Select the number of divisions of the screen from the following list of choices.

- Single: No division
- Dual: 2 divisions
- Triad: 3 divisions
- Quad: 4 divisions

The number of displayed points in the vertical direction of one divided window varies depending on the number of divisions as follows.

Single: 432 points, Dual: 216 points, Triad: 144 points, Quad: 108 points

**Waveform Mapping**

- Auto

The waveforms that are turned ON (see section 9.5) are mapped to the divided windows in order by element numbers in the order voltage (U) and current (I), followed by speed\* and torque\*.

\* Applicable only to products with the motor evaluation function (option).

- Fixed

The waveforms are mapped in order by element number in the order voltage (U) and current (I) to the divided windows regardless of whether or not the display is turned ON. Speed\* is displayed in the top frame; Torque\* is displayed in the 2nd frame from the top.

The following figure shows how the waveforms are displayed when all 6 elements are installed, with the motor evaluation function (option), the number of division is Quad, display of U1, I1, U2, I2, U3, I3, I4, and Torque is ON, and display of U4, U5, I5, U6, I6, and Speed is OFF.

**Auto**

U1, U3
I1, I3
U2, I4
I2, Torque

**Fixed**

U1, U3
I1, I3, Torque
U2
I2, I4

- User

The waveforms can be mapped arbitrarily to the divided windows regardless of whether or not the display is turned ON. You can select the display position from 0 to 3. The waveforms are mapped in order starting from number 0 from the top divided window.

**User (when the screen is divided into three windows with I1, Speed, and Torque set to 0, 1, and 3, respectively)**

I1, Torque	0, 3
Speed	1
	2

Displayed in order according to the specified number.

# 9.7 Interpolating the Display and Changing the Graticule

«For a functional description, see section 1.7.»

## Keys

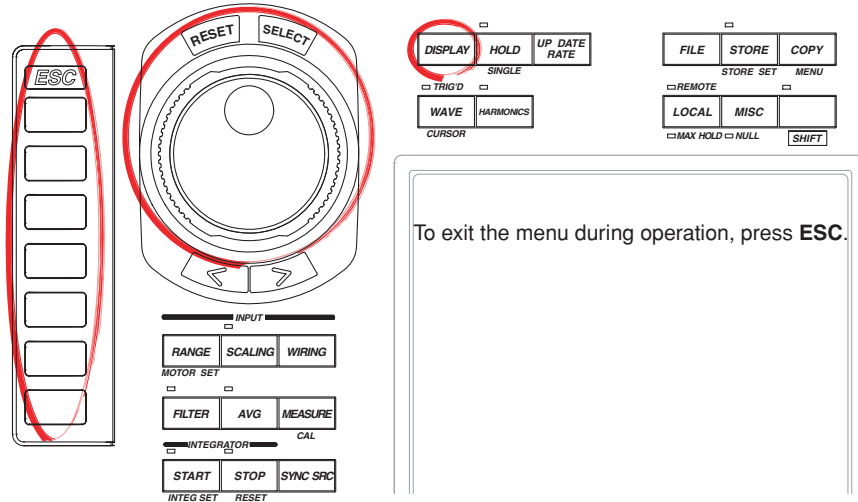

## Procedure

The retrieval of waveform display data must be turned ON to display waveforms. For the procedure, see section 9.1.

1. Press **DISPLAY** to display the Display menu.  
Check that Format (display format) is set to Wave, Numeric+Wave, Wave+Bar, or Wave+Trend. For details on setting the display format, see section 4.2.

The following procedures are given for a representative example in which the display format is set to Wave.



2. Press the **Wave Setting** soft key to display the Wave Setting menu.

### Selecting Whether to Interpolate the Display

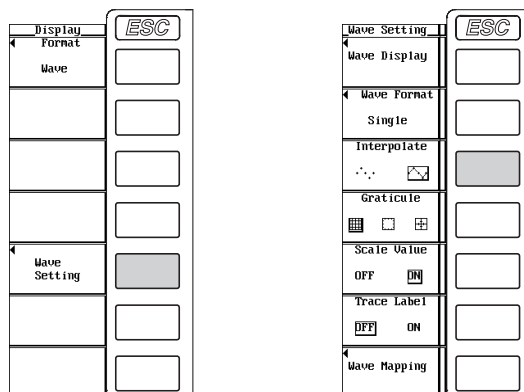
3. Press the **Interpolate** soft key to select  $\cdot \cdot \cdot$  or  $\wedge \cdot \cdot$ .



**Changing the Graticule**

3. Press the **Graticule** soft key to select , , or .

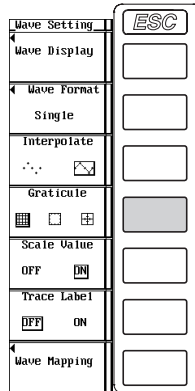

**Explanation**

**Selecting Whether to Interpolate the Display**

When there are less than 500 points of sampled data on the time axis, the area between the display points (rasters) is no longer continuous. This function interpolates between the points to display the waveforms. You can select from the following list of choices.

- : No interpolation is performed.
  - When there are 500 points or more of sampled data



- When there are less than 500 points of sampled data



- : Linearly interpolates between two points.
  - When there are 500 points or more of sampled data
  - Connects the dots vertically.



- When there are less than 500 points of sampled data



## 9.7 Interpolating the Display and Changing the Graticule

---

### Changing the Graticule

Select the grid or cross scale to display on the screen from the following list of choices.

- : Grid display

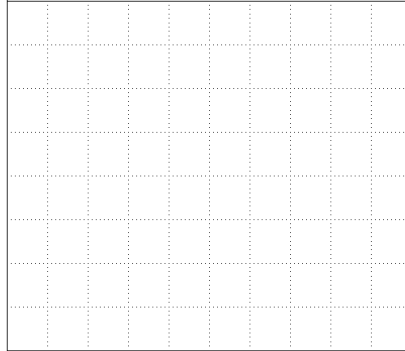

- : No grid or cross scale display

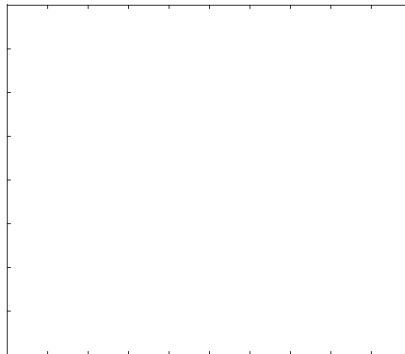

- : Cross scale display

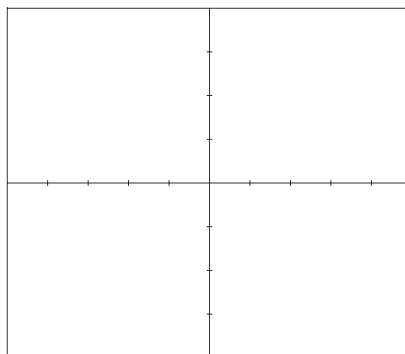



## 9.8 Turning ON/OFF the Scale Value and Waveform Label

«For a functional description, see section 1.7.»

### Keys

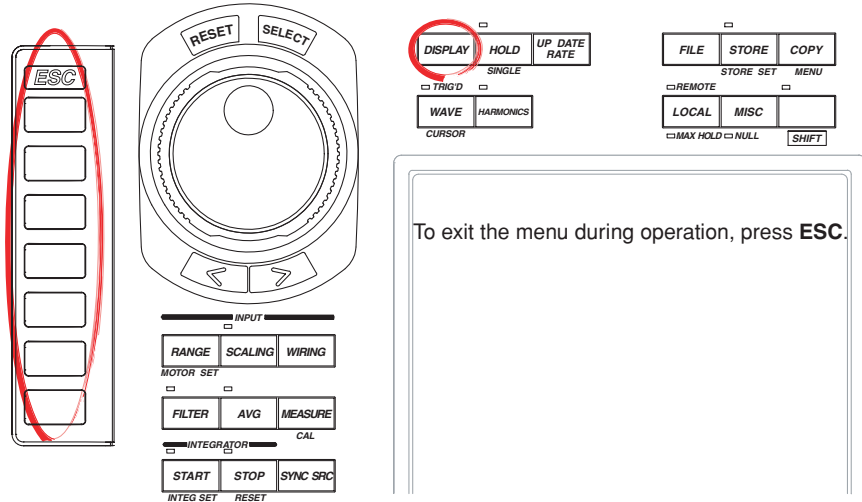

### Procedure

The retrieval of waveform display data must be turned ON to display waveforms. For the procedure, see section 9.1.

1. Press **DISPLAY** to display the Display menu. Check that Format (display format) is set to Wave, Numeric+Wave, Wave+Bar, or Wave+Trend. For details on setting the display format, see section 4.2.
2. Press the **Wave Setting** soft key to display the Wave Setting menu.

#### Turning ON/OFF the Scale Value Display

3. Press the **Scale Value** soft key to select ON or OFF.

#### Turning ON/OFF the Waveform Label

3. Press the **Trace Label** soft key to select ON or OFF.

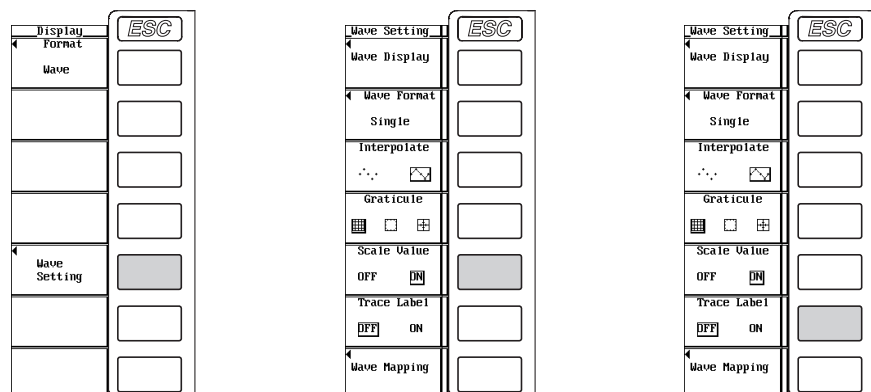

## 9.8 Turning ON/OFF the Scale Value and Waveform Label

### Explanation

#### Turning ON/OFF the Scale Value Display

You can select whether or not to display (ON/OFF) the upper and lower limits of the vertical axis and the values at the left and right ends of the horizontal axis (time axis, see section 9.2) of each channel.

- ON  
Displays the scale values.
- OFF  
Does not display the scale values.

#### Turning ON/OFF the Label Display

Select whether to display the waveform label name (input signal name).

- ON  
Displays the label name.
- OFF  
Does not display the label name.

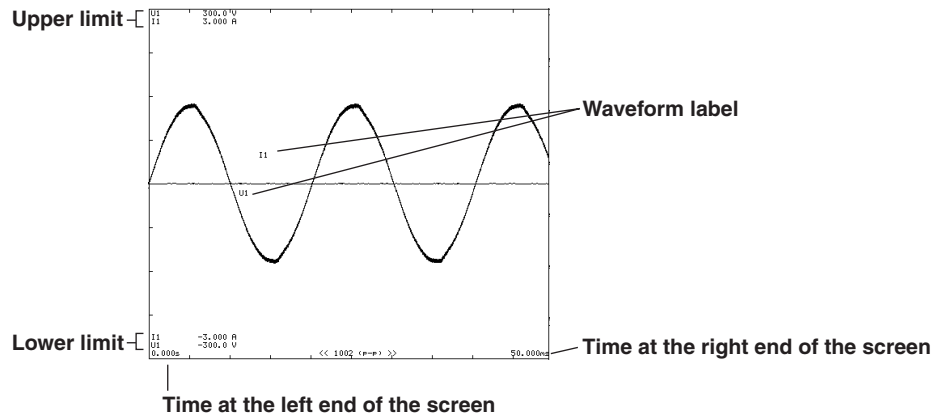

# 9.9 Performing Cursor Measurements

«For a functional description, see section 1.7.»

## Keys

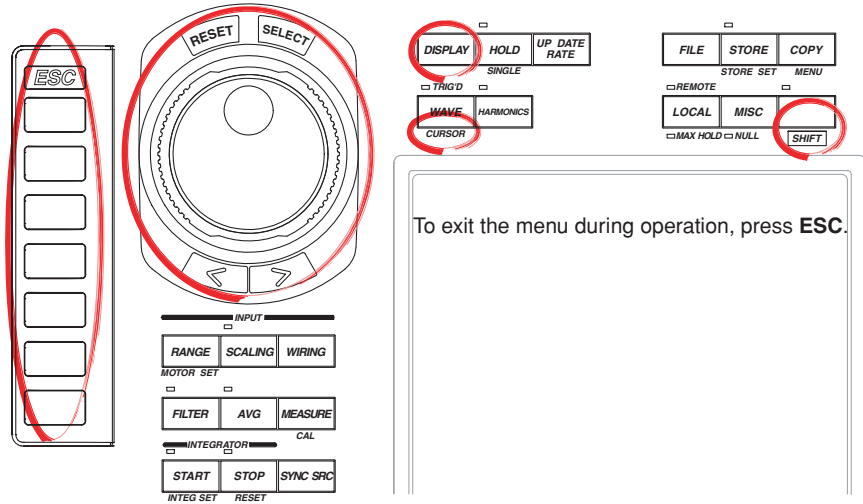

To exit the menu during operation, press **ESC**.

## Procedure

The retrieval of waveform display data must be turned ON to display waveforms. For the procedure, see section 9.1.

1. Press **DISPLAY** to display the Display menu. Check that Format (display format) is set to Wave, Numeric+Wave, Wave+Bar, or Wave+Trend. For details on setting the display format, see section 4.2.
2. Press **SHIFT+WAVE (CURSOR)** to display the Cursor menu.

### Turning ON/OFF Cursor Measurement

3. Press the **Wave Cursor** soft key to select ON or OFF. If ON is selected, the result of the cursor measurement is displayed.

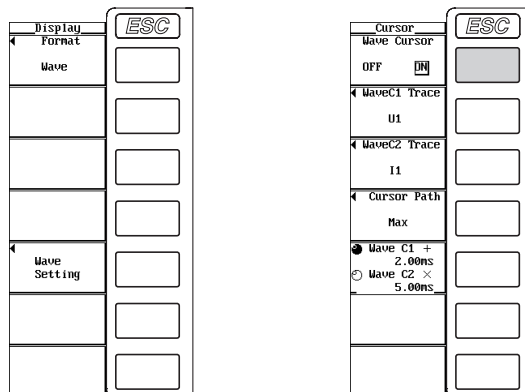

## 9.9 Performing Cursor Measurements

### Selecting the Target Waveform for Cursor Measurement

- **Selecting the target waveform for cursor +**
  4. Press the **WaveC1 Trace** soft key to display the target waveform selection box.
  5. Turn the **jog shuttle** to select any of the signals starting with U1.
  6. Press **SELECT** to confirm the new target waveform.
- **Selecting the target waveform for cursor x**
  4. Press the **WaveC2 Trace** soft key to display the target waveform selection box.
  5. Turn the **jog shuttle** to select any of the signals starting with U1.
  6. Press **SELECT** to confirm the new target waveform.

### Selecting the Movement Path of the Cursor

7. Press the **Cursor Path** soft key to display the Cursor Path menu.
8. Press one of the soft keys from **Max** to **Mid** to select the movement path.

### Moving the Cursor

9. Press the **Wave C1 +/Wave C2 x** soft key to set the jog shuttle target to Wave C1 +, Wave C2 x, or both Wave C1 + and Wave C2 x.
  - If you select Wave C1 +, the position of cursor + can be moved.
  - If you select Wave C2 x, the position of cursor x can be moved.
  - If you select both Wave C1 + and Wave C2 x, the two cursors can be moved without changing the spacing between the two. The value of the digit being specified by Wave C1 + changes.
10. Turn the **jog shuttle** to move the cursor.
 

For the procedures on how to enter values using the jog shuttle, see section 3.12, "Entering Values and Strings."

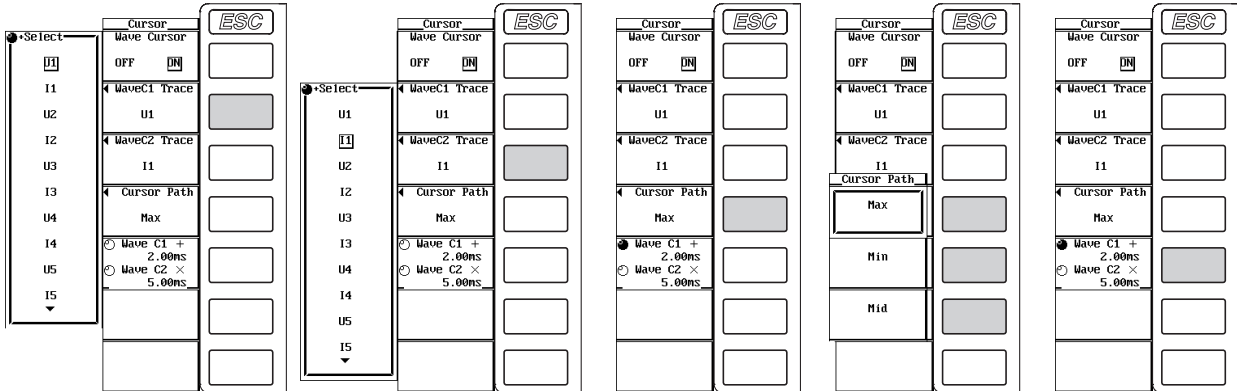

**Explanation****ON/OFF**

A cursor can be placed on the displayed waveform to measure and display the value at that point. It can be used to measure the voltage and current of various sections of the waveform and the data on the horizontal axis (X-axis).

- ON: Performs cursor measurement.
- OFF: Does not perform cursor measurement.

**Measurement Target**

Select the target waveform for the cursor measurement from the following list of choices. The selectable items vary depending on the installed elements.

U1, I1, U2, I2, U3, I3, U4, I4, U5, I5, U6, I6, Speed\*, and Torque\*

\* Applicable only on models with the motor evaluation function (option). However, during harmonic measurement, they do not appear.

**Measurement Item**

- Y+: Vertical value of cursor + (Y-axis value)
- Yx: Vertical value of cursor x (Y-axis value)
- ΔY: The difference between the Y-axis values of cursor + and cursor x
- X+: X-axis value of cursor + from the left end of the screen
- Xx: X-axis value of cursor x from the left end of the screen
- ΔX: The difference between the X-axis values of cursor + and cursor x
- 1/ΔX: The inverse of the difference between the X-axis values of cursor + and cursor x

**Movement Path of the Cursor**

Since the WT1600 P-P compresses the sampled data (see section 1.7), two data points, maximum and minimum values, are displayed at the same time axis position. This specifies where the cursor is to move.

- Max  
Moves along the maximum values on the time axis and measures the value at each point.
- Min  
Moves along the minimum values on the time axis and measures the value at each point.
- Mid  
Moves along the middle of the maximum and minimum values on the time axis and measures the value at each point.

**Cursor Movement**

- Cursors move on the selected waveform.
- The range of movement of cursors is from the left end to the right end of the screen.
- The movement step of cursors is as follows.
  - For normal measurement, the step is equal to (time corresponding to one screen) ÷ 500.
  - For harmonic measurement, the step is 1 point.

**Note**

- If unmeasurable data exists, "\*\*\*\*" is displayed in the measured value display area.
- ΔY is measured even if the unit is different. The result has no unit in this case.
- If the crest factor is set to 3, the allowed range of cursor measurement vertically is ±300% of the range. However, for 1000 V range, the range is within ±200%. If the crest factor is set to 6, it is ±600% of the range. However, for 500 V range, the range is within ±400%.

# 10.1 Retrieving Trend Display Data

«For a functional description, see section 1.8.»

## Keys

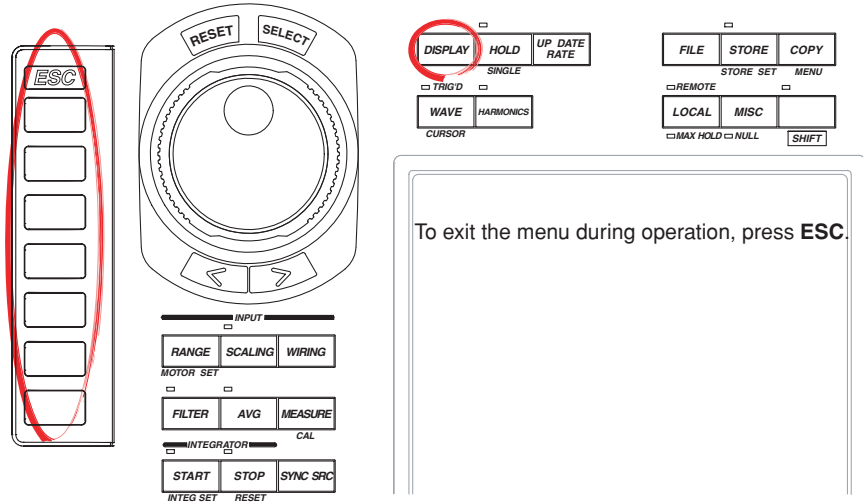

## Procedure

1. Press **DISPLAY** to display the Display menu. Check that Format (display format) is set to Trend, Numeric+Trend, Wave+Trend, or Bar+Trend. For details on setting the display format, see section 4.5.
2. Press the **Trend Setting** soft key to display the Trend Setting menu.

### Selecting Whether to Retrieve Trend Data (ON/OFF)

3. Press the **Trend Sampling** soft key to select ON or OFF. If ON is selected, the retrieval of trend waveform data starts.

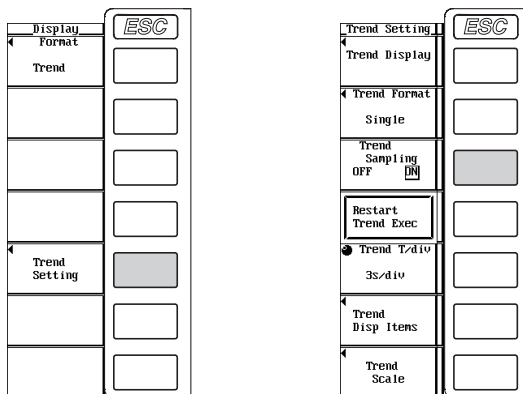

## Explanation

The retrieval of trend display data must be turned ON to display trends. The numerical data of the measurement function is P-P compressed\* and stored to the memory as trend display data.

\* P-P compression is performed when there are more than two points of data at a single display segment.

- ON  
The retrieval of trend waveform data starts.
- OFF  
Trend display data is not retrieved.

## 10.2 Selecting the Trend Display Target

«For a functional description, see section 1.8.»

### Keys

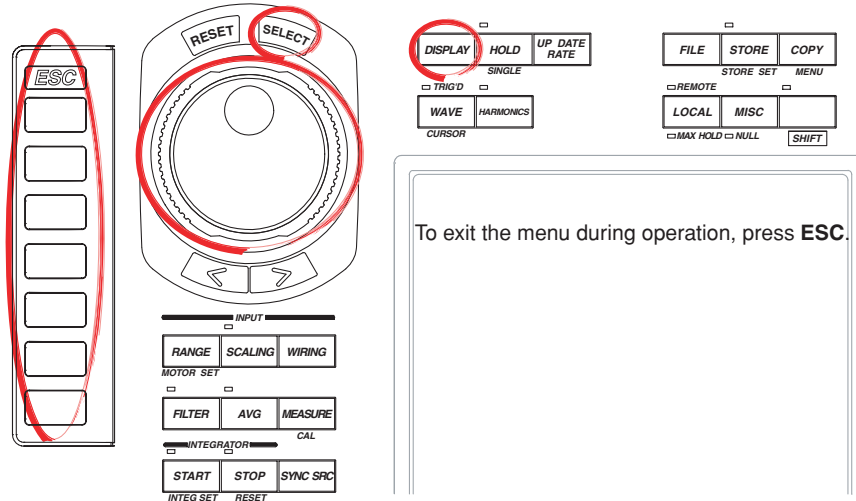

### Procedure

1. Press **DISPLAY** to display the Display menu. Check that Format (display format) is set to Trend, Numeric+Trend, Wave+Trend, or Bar+Trend. For details on setting the display format, see section 4.5.

The following procedures are given for a representative example in which the display format is set to Trend.

2. Press the **Trend Setting** soft key to display the Trend Setting menu.
3. Press the **Trend Disp Items** soft key to display the Trend Items menu.

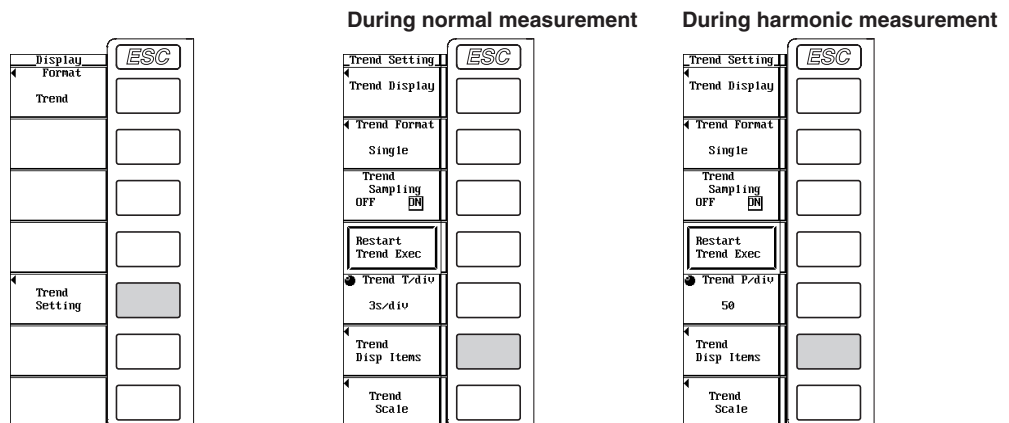

## During Normal Measurement

### Selecting the Item to Be Set

4. Turn the **jog shuttle** to select T1 to T16.

### Selecting the Measurement Function

5. Press the **Function** soft key to display the measurement function selection box.
6. Turn the **jog shuttle** to select any of the measurement function starting with None.
7. Press **SELECT** to confirm.

### Selecting the Element/Wiring Unit

8. Press the **Element** soft key to display the element/wiring unit selection box.
9. Turn the **jog shuttle** to select any of the elements/wiring units starting with Element1.
10. Press **SELECT** to confirm.

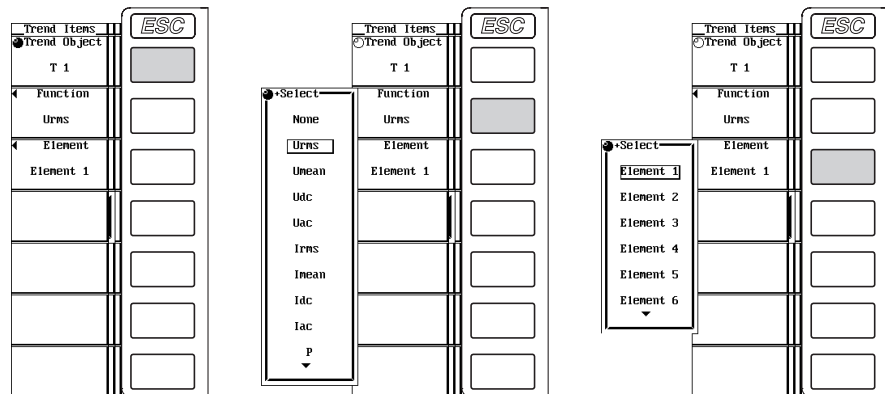



## 10.2 Selecting the Trend Display Target

### During Harmonic Measurement

#### Selecting the Item to Be Set

4. Press the **Trend Object** soft key.
5. Turn the **jog shuttle** to select T1 to T16.

#### Selecting the Measurement Function

6. Press the **Function** soft key to display the measurement function selection box.
7. Turn the **jog shuttle** to select any of the measurement function starting with None.
8. Press **SELECT** to confirm.

#### Selecting the Element/Wiring Unit

9. Press the **Element** soft key to display the element/wiring unit selection box.
10. Turn the **jog shuttle** to select any of the elements/wiring units starting with Element1.
11. Press **SELECT** to confirm.

#### Selecting the Harmonic Order

12. Press the **Order** soft key.
13. Turn the **jog shuttle** to select the order from Total and 0 to the maximum harmonic order (see section 7.5).

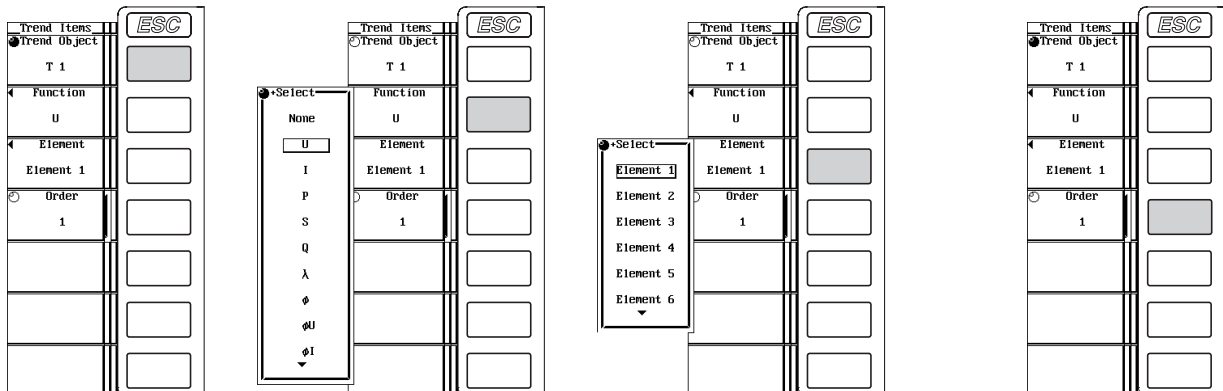

**Explanation**

Set the item to be shown on the trend display. You can set 16 lines of trends, trend 1 (T1) through trend 16 (T16).

**During Normal Measurement****Selecting the Measurement Function**

- The types of measurement functions that can be selected are the items that are indicated in “Measurement Function Types during Normal Measurement” and “Measurement Function Types for Motor Evaluation Function (Option)” in section 1.2; “Delta Computation,” “User-Defined Function,” and “Corrected Power” in section 1.5; and “Measurement Functions of Integration” in section 1.6.
- You can also select not to display the measurement functions (None).
- If you selected measurement functions of delta computation, the meanings of the elements described in the next section are different from when other measurement functions are selected. For details, see the explanation in section 6.1.

**Selecting the Element/Wiring Unit**

- You can select the element/wiring unit from the following list of choices. The selectable items vary depending on the installed elements. Element1, Element2, Element3, Element4, Element5, Element6,  $\Sigma A$ ,  $\Sigma B$ , and  $\Sigma C$
- If there are no elements that are assigned to the selected wiring unit, there is no numerical data. Thus, the trend is not displayed in this case. For example, if elements are assigned to  $\Sigma A$  and  $\Sigma B$  and no elements are assigned to  $\Sigma C$ , then the trend at the measurement function for  $\Sigma C$  is not displayed.

**During Harmonic Measurement****Selecting the Measurement Function**

- The types of measurement functions that can be selected are indicated in “Measurement Function Types for Harmonic Measurement” in section 1.2 and “User-Defined Functions” in section 1.5.
- You can also select not to display the measurement functions (None).

**Selecting the Element/Wiring Unit**

- You can select the element/wiring unit from the following list of choices. The selectable items vary depending on the installed elements. Element1, Element2, Element3, Element4, Element5, Element6,  $\Sigma A$ ,  $\Sigma B$ , and  $\Sigma C$
- If the selected wiring unit is not a harmonic measurement target, there is no numerical data. Thus, the trend is not displayed in this case. For example, if the measurement target is  $\Sigma A$ , the trend at the measurement function of  $\Sigma C$  is not displayed. For selecting the measurement target, see section 7.3.

**Changing the Harmonic Order**

The harmonic order can be set to total or from dc (0<sup>th</sup> order) up to 100<sup>th</sup> order.

**Note**

- For the meanings of the measurement function symbols that are displayed, see section 1.2, “Measurement Functions and Measurement Periods,” 1.5, “Computation,” 1.6, “Integration,” appendix 1, “Symbols and Determination of Measurement Functions,” and appendix 2, “Determination of Delta Computation.”
- For details on the wiring units expressed as  $\Sigma A$ ,  $\Sigma B$ , and  $\Sigma C$ , see section 5.1, “Selecting the Wiring System.”
- The trend is not displayed in places where the measurement function is not selected or where numerical data is not present.
- The harmonic order can be set to total or from dc (0<sup>th</sup> order) up to 100<sup>th</sup> order. However, the data determined by the harmonic measurement is the numerical data from the minimum harmonic order to be analyzed as specified in section 7.5 (Min Order) to the maximum order to be analyzed (see section 17.6) that is automatically determined by the frequency of the PLL source.
- If you change the item for which the trend is displayed, only the modified trend is cleared, and the new trend is displayed from the cleared point (position).

## 10.3 Turning ON/OFF the Trend Display

### Keys

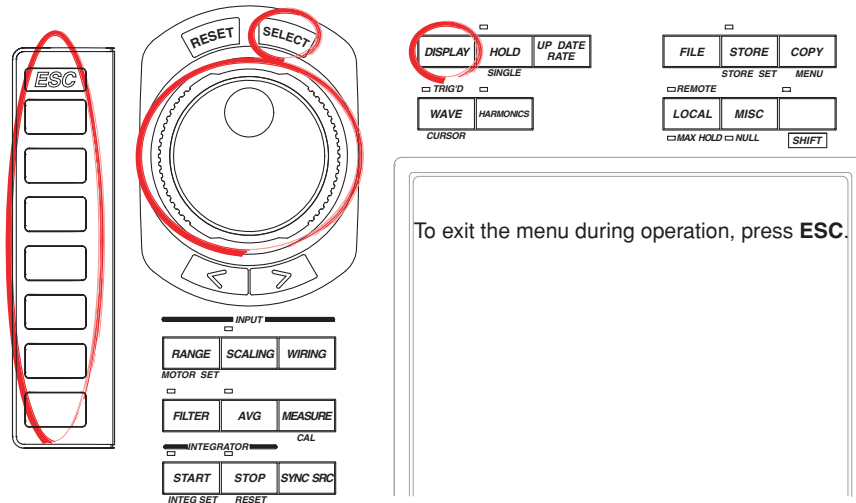

### Procedure

The retrieval of trend display data must be turned ON to display trends. For the procedure, see section 10.1.

1. Press **DISPLAY** to display the Display menu. Check that Format (display format) is set to Trend, Numeric+Trend, Wave+Trend, or Bar+Trend. For details on setting the display format, see section 4.5.

The following procedures are given for a representative example in which the display format is set to Trend.

2. Press the **Trend Setting** soft key to display the Trend Setting menu.

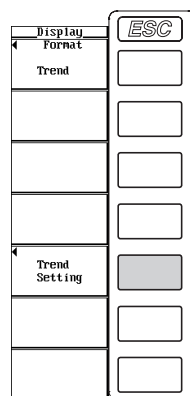

- Press the **Trend Display** soft key to display the Trend Display dialog box.

#### Turning ON/OFF the Trend Display at Once

- **Turning ON the display of all trends at once**

- Turn the **jog shuttle** to select All ON.
- Press **SELECT**. All the buttons to the left of the trend symbols are highlighted. In addition, if the retrieval of the trend display data (see section 10.1) is ON, the trends are displayed.

- **Turning OFF the display of all trends at once**

- Turn the **jog shuttle** to select All OFF.
- Press **SELECT**. The highlighting of all the buttons to the left of the trend symbols is cleared and the trends are no longer displayed.

#### Turning ON/OFF the Trend One at a Time

- Turn the **jog shuttle** to select the desired trend symbol.
- Press **SELECT**. If the retrieval of the trend display data (see section 10.1) is ON and the button to the left of the selected trend symbol is highlighted, the corresponding trend is displayed. If the highlighting of the button is cleared, the trend is no longer displayed.

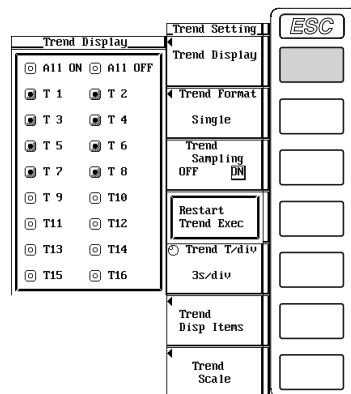

#### Explanation

You can turn ON/OFF the 16 lines of trends, trend 1 (T1) through trend 16 (T16). The trend display varies depending on the time axis (T/div) setting of section 10.5. For example, if T/div is 3 s and the data update rate is set to 50 ms, the trend display is updated every second. If T/div is 1 day and the data update rate is set to 50 ms, the trend display is updated every 1728 s.

# 10.4 Splitting the Screen and Displaying Trends

«For a functional description, see section 1.8.»

## Keys

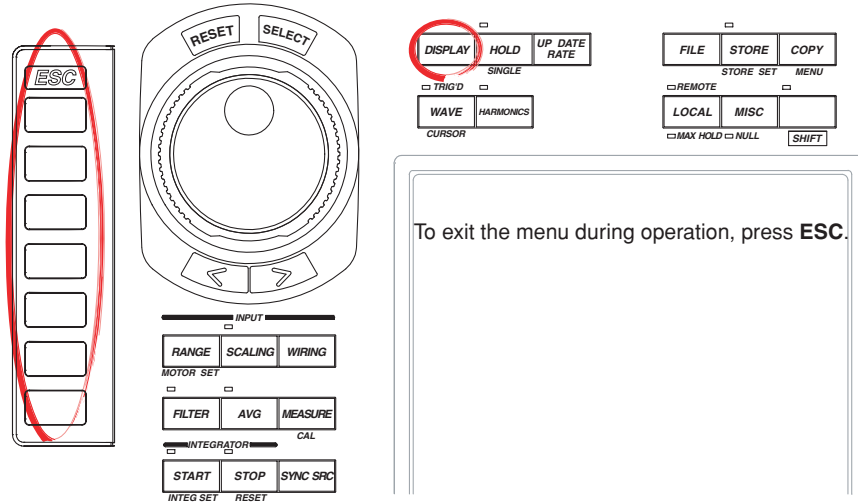

## Procedure

The retrieval of trend display data must be turned ON to display trends. For the procedure, see section 10.1.

1. Press **DISPLAY** to display the Display menu. Check that Format (display format) is set to Trend, Numeric+Trend, Wave+Trend, or Bar+Trend. For details on setting the display format, see section 4.5.

The following procedures are given for a representative example in which the display format is set to Trend.

2. Press the **Trend Setting** soft key to display the Trend Setting menu.
3. Press the **Trend Format** soft key to display the Format menu.
4. Press one of the keys from **Single** to **Quad** to select the number of windows.

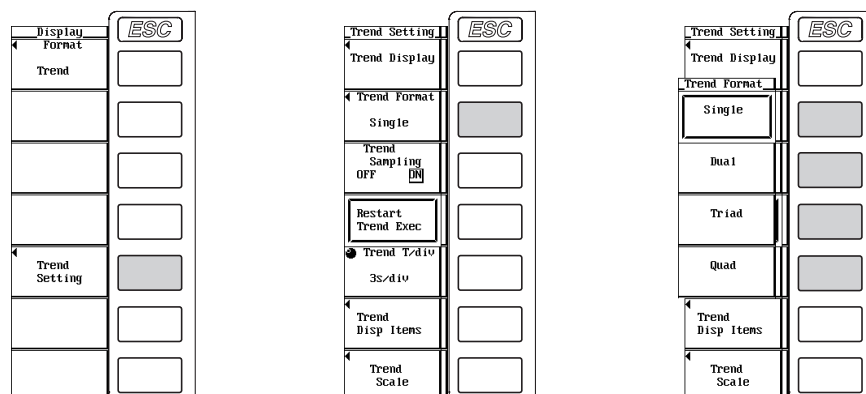

### Explanation

The screen can be evenly divided and the trends can be mapped to the divided windows.

#### Selecting the Number of Windows

Same as the waveform display (section 9.6).

#### Waveform Mapping

The trends that are turned ON (see section 10.3) are mapped in order according to the trend number (T1 to T16) to the divided windows. This corresponds to the “Auto” setting for the waveform display.

## 10.5 Setting the Time Axis

«For a functional description, see section 1.8.»

### Keys

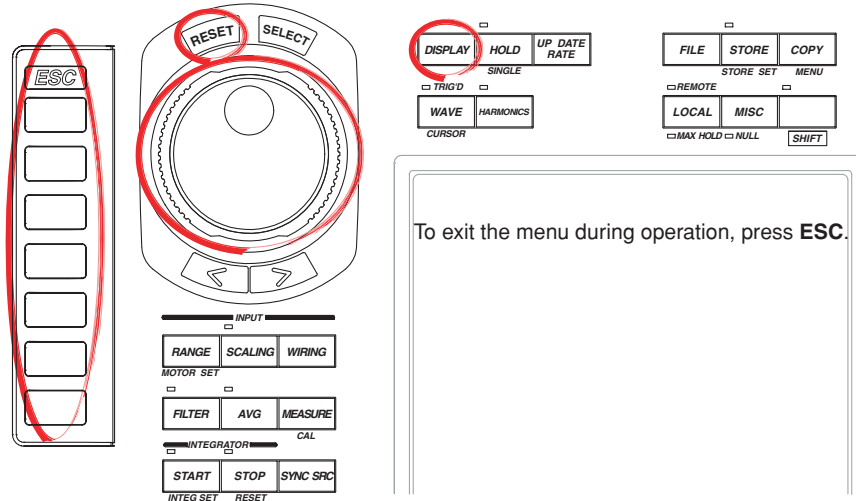

### Procedure

The retrieval of trend display data must be turned ON to display trends. For the procedure, see section 10.1.

1. Press **DISPLAY** to display the Display menu.  
Check that Format (display format) is set to Trend, Numeric+Trend, Wave+Trend, or Bar+Trend. For details on setting the display format, see section 4.5.

The following procedures are given for a representative example in which the display format is set to Trend.

2. Press the **Trend Setting** soft key to display the Trend Setting menu.

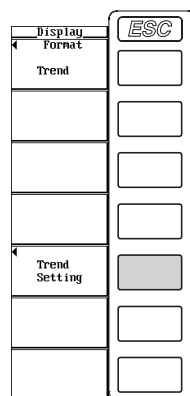

**During Normal Measurement When the Retrieval of Waveform Display Data (see section 9.1) Is OFF**

- Turn the **jog shuttle** to set the time axis. When the display of scale values is turned ON (see section 9.8), the time at the left end and the right end of the screen are displayed at the lower left corner (fixed to 0 s) and lower right corner of the screen, respectively.

**During Normal Measurement When the Retrieval of Waveform Display Data Is ON**

- Turn the **jog shuttle** to set the time axis (horizontal axis). When the display of scale values is turned ON, the data point number at the left end (fixed to 0) and the right end of the screen are displayed at the lower left corner and lower right corner of the screen, respectively.

**During Harmonic Measurement**

- Turn the **jog shuttle** to set the time axis (horizontal axis). When the display of scale values is turned ON, the data point number at the left end (fixed to 0) and the right end of the screen are displayed at the lower left corner and lower right corner of the screen, respectively.

During normal measurement

Trend Setting	ESC
Trend Display	
Trend Format	
Single	
Trend Sampling	
OFF	ON
Restart Trend Exec	
Trend T/div	
3s/div	
Trend Disp Items	
Trend Scale	

During harmonic measurement

Trend Setting	ESC
Trend Display	
Trend Format	
Single	
Trend Sampling	
OFF	ON
Restart Trend Exec	
Trend P/div	
50	
Trend Disp Items	
Trend Scale	

**Explanation**

**During Normal Measurement When the Retrieval of Waveform Display Data (see section 9.1) Is OFF**

- Set the time axis in terms of T/div (time per grid).
- Set the time per division in the range of 3 s to 1 day.

**During Normal Measurement When the Retrieval of Waveform Display Data Is ON**

- Set the time axis (horizontal axis) in terms of P/div (points per grid).
- Set the number of data points per division in the range of 1 to 500.

**During Harmonic Measurement**

- Set the time axis (horizontal axis) in terms of P/div (points per grid).
- Set the number of data points per division in the range of 1 to 500.

**Note**

If the time axis is changed, the retrieval of trend waveform data restarts. The trend display up to that point is cleared and the trend starts from the left end of the screen.



## 10.6 Setting the Scale

### Keys

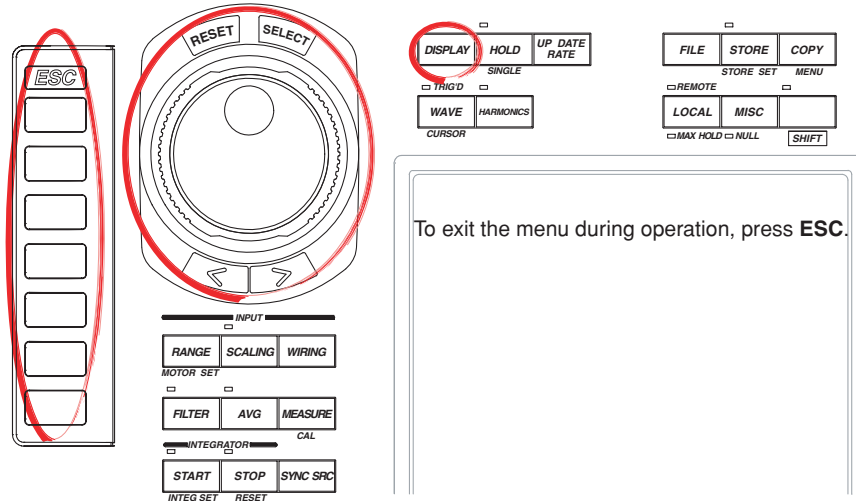

### Procedure

The retrieval of trend display data must be turned ON to display trends. For the procedure, see section 10.1.

1. Press **DISPLAY** to display the Display menu. Check that Format (display format) is set to Trend, Numeric+Trend, Wave+Trend, or Bar+Trend. For details on setting the display format, see section 4.5.

The following procedures are given for a representative example in which the display format is set to Trend.

2. Press the **Trend Setting** soft key to display the Trend Setting menu.
3. Press the **Trend Scale** soft key to display the Trend Scale menu.

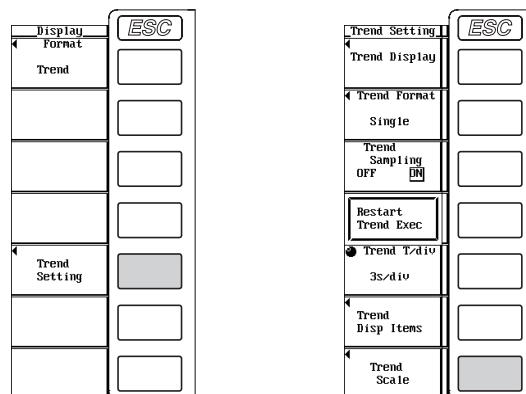

**Selecting the Target Trend to Be Scaled**

4. Press the **Trend Object** soft key.
5. Turn the **jog shuttle** to select T1 to T16.

**Selecting Auto Scaling or Manual Scaling**

6. Press the **Scaling** soft key to select Auto or Manual.

**Setting the Upper Limit during Manual Scaling**

7. Press the **Upper Scale** soft key.
8. Turn the **jog shuttle** to set the upper limit.

For the procedures on how to enter values using the jog shuttle, see section 3.12, "Entering Values and Strings."

**Setting the Lower Limit during Manual Scaling**

7. Press the **Lower Scale** soft key.
8. Turn the **jog shuttle** to set the lower limit.

For the procedures on how to enter values using the jog shuttle, see section 3.12, "Entering Values and Strings."

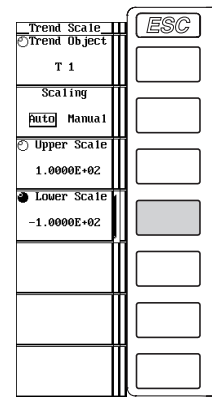
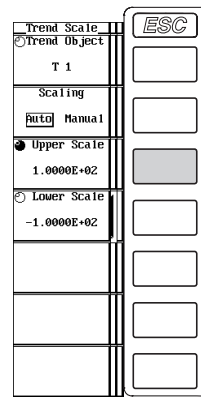
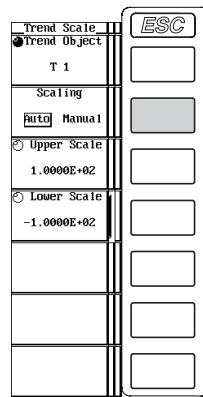
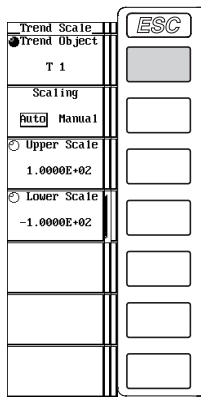
**Explanation****Setting the Scale**

Set the upper and lower limits of the display frame when displaying the trend. You can select the scaling method from the following list of choices.

- **Auto**  
Set to auto scaling. The upper and lower limits on the screen display are automatically determined from the maximum and minimum values of the trend display data.
- **Manual**  
Set to manual scaling. The upper and lower limits can be set arbitrary as necessary.

**Setting the Upper and Lower Limits during Manual Scaling**

You can set the limits in the range of  $-9.9999E+30$  to  $9.9999E+30$ .

**Note**

The setting in section 9.8 determines whether the upper and lower limits and labels are displayed.

# 10.7 Performing Cursor Measurements

«For a functional description, see section 1.7.»

## Keys

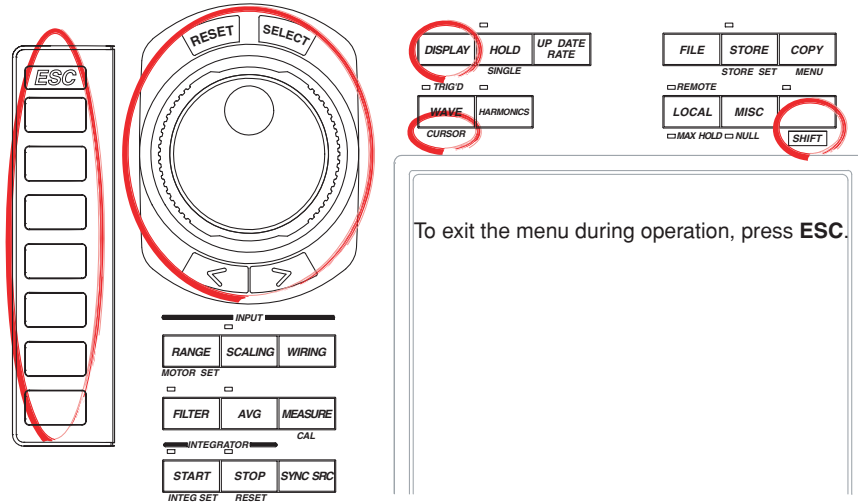

To exit the menu during operation, press **ESC**.

## Procedure

The retrieval of trend display data must be turned ON to display trends. For the procedure, see section 10.1.

1. Press **DISPLAY** to display the Display menu. Check that Format (display format) is set to Trend, Numeric+Trend, Wave+Trend, or Bar+Trend. For details on setting the display format, see section 4.5.
2. Press **SHIFT+WAVE (CURSOR)** to display the Cursor menu.

### Turning ON/OFF Cursor Measurement

3. Press the **Trend Cursor** soft key to select ON or OFF. If ON is selected, the result of the cursor measurement is displayed.

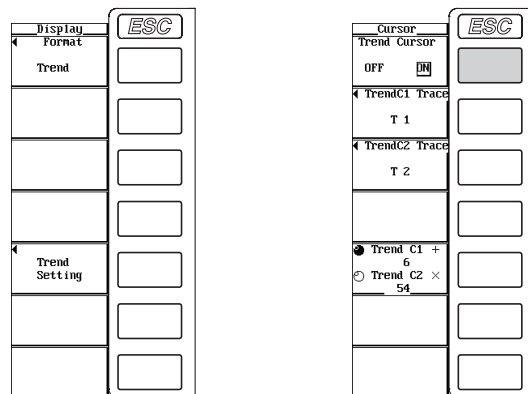

**Selecting the Target Trend for Cursor Measurement**

• **Selecting the target trend for cursor +**

4. Press the **TrendC1 Trace** soft key to display the target trend selection box.
5. Turn the **jog shuttle** to select T1 to T16.
6. Press **SELECT** to confirm the new target trend.

• **Selecting the target trend for cursor x**

4. Press the **TrendC2 Trace** soft key to display the target trend selection box.
5. Turn the **jog shuttle** to select T1 to T16.
6. Press **SELECT** to confirm the new target trend.

**Moving the Cursor**

7. Press the **Trend C1 +/-Trend C2 x** soft key to set the jog shuttle target to Trend C1 +, Trend C2 x, or both Trend C1 + and Trend C2 x.
  - If you select Trend C1 +, the position of cursor + can be moved.
  - If you select Trend C2 x, the position of cursor x can be moved.
  - If you select both Trend C1 + and Trend C2 x, the two cursors can be moved without changing the spacing between the two. The value of the digit being specified by Trend C1 + changes.
8. Turn the **jog shuttle** to move the cursor.
 

For the procedures on how to enter values using the jog shuttle, see section 3.12, "Entering Values and Strings."

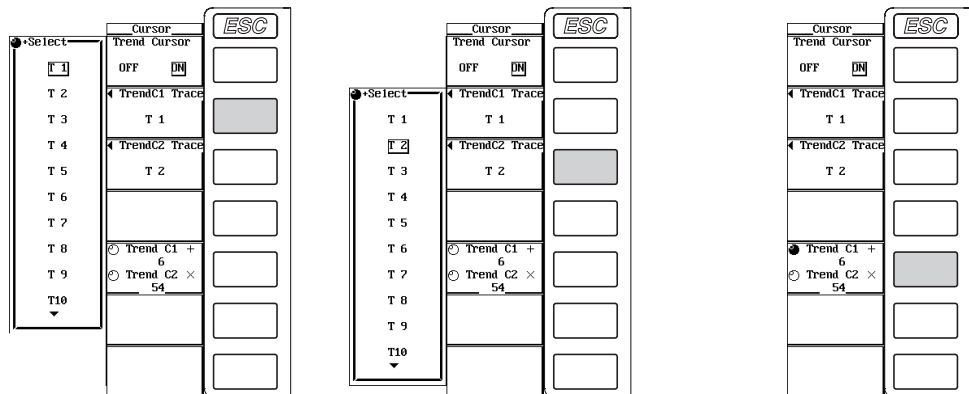

### Explanation

#### ON/OFF

A cursor can be placed on the displayed trend to measure and display the value at that point. It can be used to measure the data on the vertical axis (Y-axis) and horizontal axis (X-axis) of various sections of the trend.

- ON: Performs cursor measurement.
- OFF: Does not perform cursor measurement.

#### Measurement Target

Select the target trend for the cursor measurement from T1 to T16.

#### Measured Items

- Y+: Vertical value of cursor + (Y-axis value)
- Yx: Vertical value of cursor x (Y-axis value)
- $\Delta Y$ : The difference between the Y-axis values of cursor + and cursor x
- X+: X-axis value of cursor + from the left end of the screen
  - During normal measurement (retrieval of waveform display data ON, see section 9.1).  
Indicates the position of cursor + in terms of data points from the left end of the screen with the left end of the screen taken to be the 0 point.
  - During normal measurement (retrieval of waveform display data OFF)  
Indicates the relative time of cursor + from the left end of the screen with the left end of the screen taken to be 0 s. The numerical value on the menu indicates the position of cursor + in terms of data points from the left end of the screen with the left end of the screen taken to be the 0 point.
  - During Harmonic Measurement  
Indicates the position of cursor + in terms of data points from the left end of the screen with the left end of the screen taken to be the 0 point.
- Xx: X-axis value of cursor x from the left end of the screen
  - During normal measurement (retrieval of waveform display data ON)  
Indicates the position of cursor x in terms of data points from the left end of the screen with the left end of the screen taken to be the 0 point.
  - During normal measurement (retrieval of waveform display data OFF)  
Indicates the relative time of cursor x from the left end of the screen with the left end taken to be 0 s. The numerical value on the menu indicates the position of cursor x in terms of data points from the left end of the screen with the left end of the screen taken to be the 0 point.
  - During Harmonic Measurement  
Indicates the position of cursor x in terms of data points from the left end of the screen with the left end of the screen taken to be the 0 point.
- $\Delta X$ : The difference between the X-axis values of cursor + and cursor x
- D+: Data and time at the cursor + position
  - During normal measurement (retrieval of waveform display data OFF)  
Indicates the date and time (year/month/date hour:minute:second) of measurement.
  - During harmonic measurement and normal measurement (retrieval of waveform display data ON)  
Not displayed.

- Dx: Date and time of cursor x position
  - During normal measurement (retrieval of waveform display data OFF)  
Indicates the date and time (year/month/date hour:minute:second) of measurement.
  - During harmonic measurement and normal measurement (retrieval of waveform display data ON)  
Not displayed.

### Cursor Movement

- Cursors move on the selected trend.
- The range of movement of cursors is from the left end to the right end of the screen.
- The cursors moves along the data points displayed on the screen one point at a time.

### Note

- If unmeasurable data exists, "\*\*\*\*" is displayed in the measured value display area.
  - $\Delta Y$  is measured even if the unit is different. The result has no unit in this case.
-

## 10.8 Restarting the Trend

### Keys

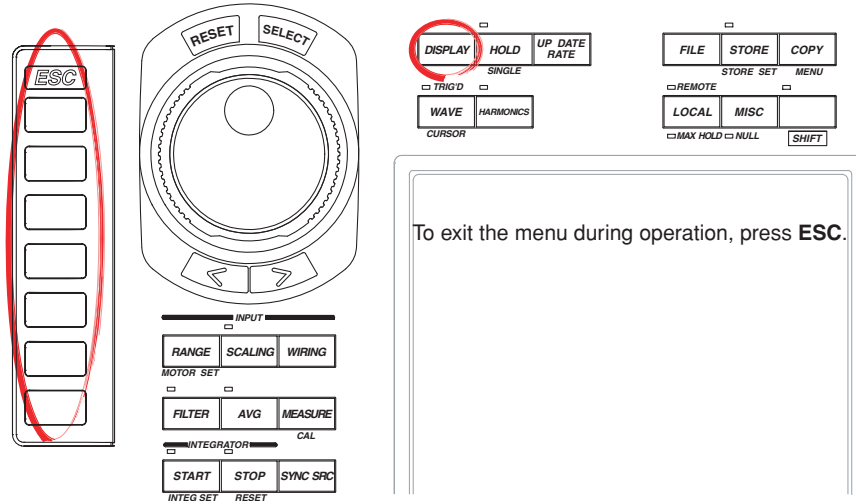

### Procedure

The retrieval of trend display data must be turned ON to display trends. For the procedure, see section 10.1.

1. Press **DISPLAY** to display the Display menu. Check that Format (display format) is set to Trend, Numeric+Trend, Wave+Trend, or Bar+Trend. For details on setting the display format, see section 4.5.

The following procedures are given for a representative example in which the display format is set to Trend.

2. Press the **Trend Setting** soft key to display the Trend Setting menu.
3. Press the **Restart Trend Exec** soft key to restart the trend.

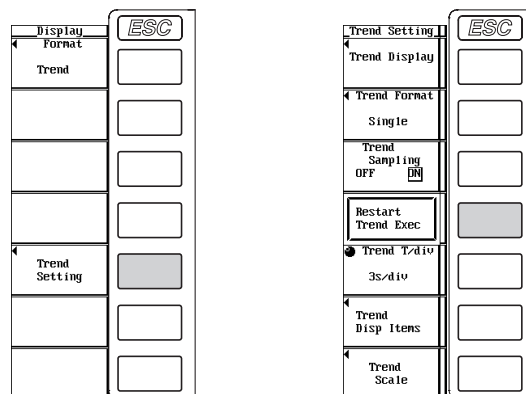

**Explanation**

When the trend is restarted, the trend up to that point is cleared.

In addition to pressing the Restart Trend Exec soft key, the following operations cause the trend to be restarted.

- Changing the data update rate
- Changing the time axis setting of the trend
- Turning ON/OFF the harmonic measurement mode
- Turning ON/OFF the retrieval of waveform display data
- Turning ON/OFF the retrieval of trend data

**Note**

If you change the item for which the trend is displayed (see section 10.2), only the modified trend is cleared, and the new trend is displayed from the cleared point (position).



# 11.1 Setting the Store Mode

## Keys

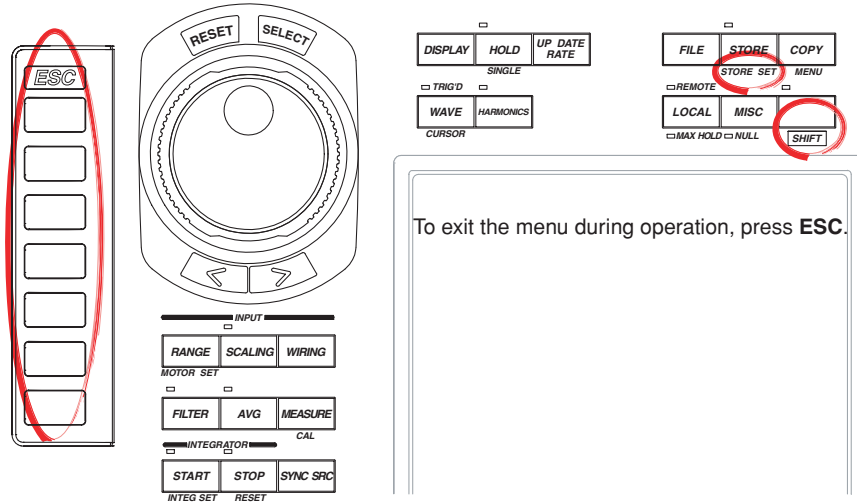

To exit the menu during operation, press **ESC**.

## Procedure

1. Press **SHIFT+STORE (STORE SET)** to display the Store Set dialog box.
2. Press the **Mode** soft key to select Store.
3. Press the **Store Setting** soft key to display the Store Setting dialog box.
4. Press the **Mode** soft key to display the Mode menu.
5. Press one of **Manual** to **Integ Sync** soft keys to select the store mode.

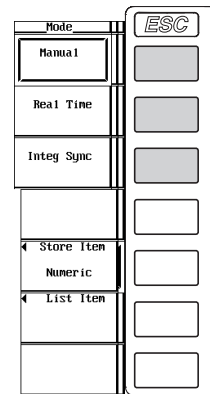
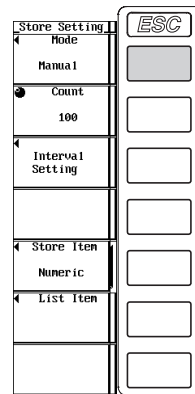
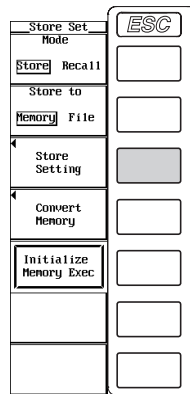
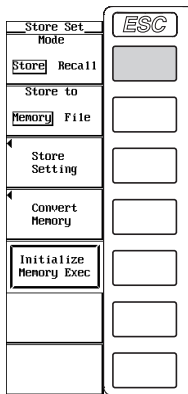

### Explanation

To store data, parameters such as the store mode, the store count, the store interval, and the store reservation time must be specified before executing the operation. This section explains the store mode. For the procedure on how to set the store count, the store interval, and the store reservation time, see section 11.2; for the procedure on how to start the store operation, see section 11.4.

#### Store Mode

You can select the timing used to start or end the store operation from the following list of choices.

- **Manual**

This is the manual mode. When you press STORE, the numerical data or waveform display data can be stored at the specified store interval for the specified store counts.

- **Real Time**

This is the real-time mode. When you press STORE, the numerical data or waveform display data can be stored from the specified reservation time for starting the store operation at the specified store interval for the specified store counts (or until the reservation time for ending the store operation).

- **Integ Sync**

- This is the integration synchronization mode. When you press STORE, the numerical data or waveform display data can be stored when the integration starts at the specified store interval for the specified store counts (or until the integration is stopped).
- By setting the time of the integration timer (see section 6.8 or 6.9) to an integer multiple of the store interval, the integrated values at integration start and integration stop that are repeated according to the time setting of the integration timer can be stored.

# 11.2 Setting the Store Count, the Store Interval, and the Store Reservation Time

## Keys

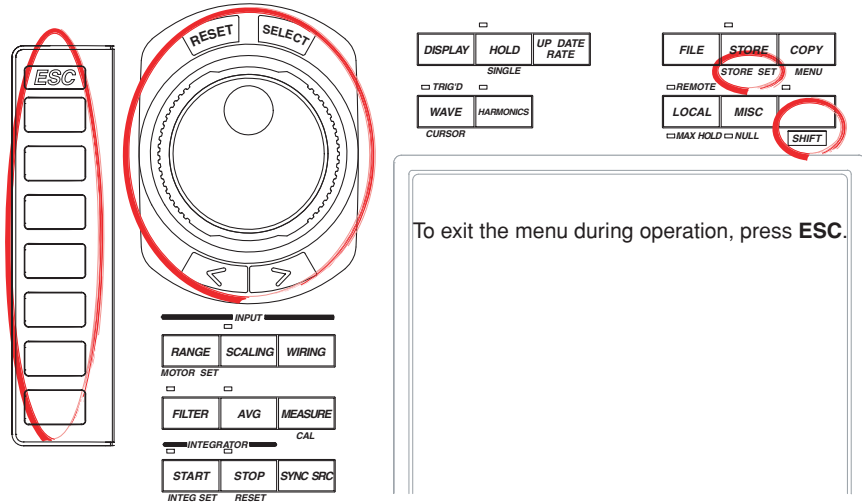

To exit the menu during operation, press **ESC**.

## Procedure

1. Press **SHIFT+STORE (STORE SET)** to display the Store Set dialog box.
2. Press the **Mode** soft key to select Store.
3. Press the **Store Setting** soft key to display the Store Setting dialog box.

### Setting the Store Count

4. Turn the **jog shuttle** to set the store count.

### Setting the Store Interval

4. Press the **Interval Setting** soft key to display the Interval Setting dialog box.
5. Turn the **jog shuttle** to select one of the hour, minute, and second boxes.
6. Press **SELECT**. A box used to set the time appears.
7. Turn the **jog shuttle** to set the hour, minute, or second that you selected in step 5.  
For the procedures on how to enter values using the jog shuttle, see section 3.12, "Entering Values and Strings."
8. Press **SELECT** or **ESC** to close the box.
9. Repeat steps 5 to 8 to set hour, minute, and second.

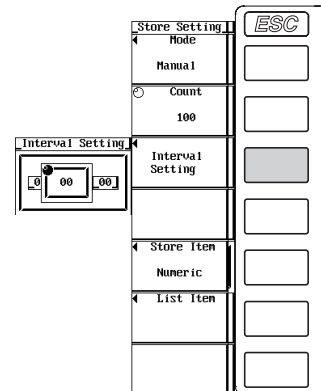
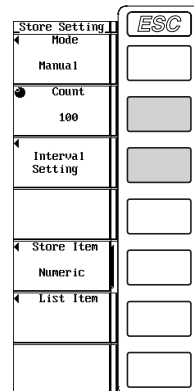
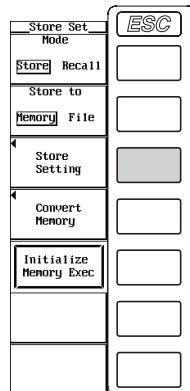
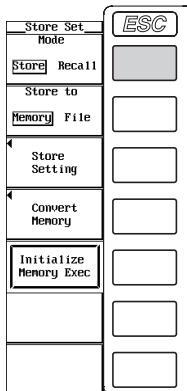

## 11.2 Setting the Store Count, the Store Interval, and the Store Reservation Time

### Setting the Store Reservation Time

4. Press the **Mode** soft key to display the Mode menu.
5. Press the **Real Time** soft key to select the real-time mode. The store reservation time menu appears.
6. Press the **Real Time Control** soft key to display the Real Time Control dialog box.
7. Turn the **jog shuttle** to select one of the reservation year, month, date, hour, minute, and second boxes for specifying when the store operation will start (Store Start).
8. Press **SELECT**. A box used to set the time appears.
9. Turn the **jog shuttle** to set the year, month, date, hour, minute, or second that you selected in step 7.

For the procedures on how to enter values using the jog shuttle, see section 3.12, "Entering Values and Strings."

10. Press **SELECT** or **ESC** to close the box.
11. Repeat steps 7 to 10 to set the year, month, date, hour, minute, and second.
12. Turn the **jog shuttle** to select one of the reservation year, month, date, hour, minute, and second boxes for specifying when the store operation will end (Store End).
13. Repeat steps 8 to 11 to set the year, month, date, hour, minute, and second.

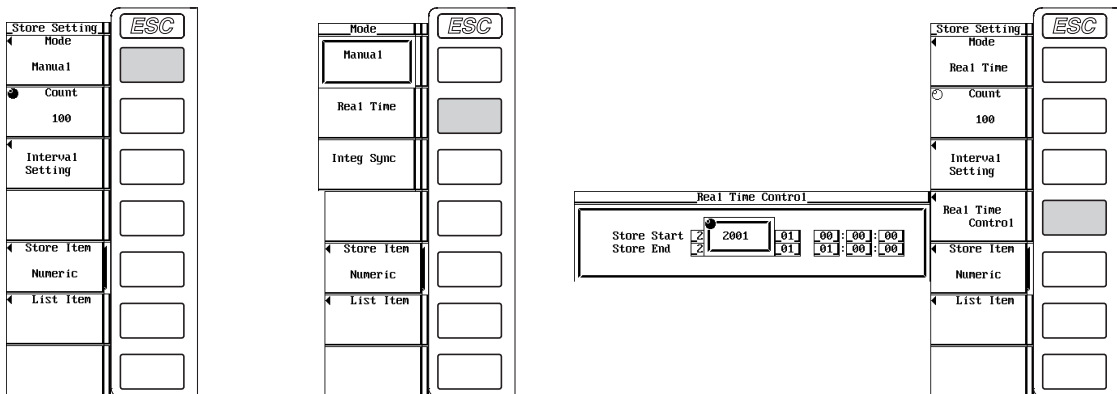

### Explanation

To store data, parameters such as the store mode, the store count, the store interval, and the store reservation time must be specified before executing the operation. This section explains the store count, the store interval, and the store reservation time. For the procedure on how to set the store mode, see section 11.1; for the procedure on how to start the store operation, see section 11.4.

#### Setting the Store Count

- Set the store count in the range from 1 to 999999.
- If the data being stored exceeds the internal memory size (approximately 12 MB, or approximately 11 MB when using a WT1600 with ROM version 2.01 or later) of the store destination, the store operation stops before reaching the specified store count.

#### Setting the Store Interval

Set the interval at which the data is to be stored.

- Set the interval in units of hour : minute : second in the following range. If the interval is set to 00:00:00, the data is stored in sync with the updating of the numerical data or waveform display data.  
00 : 00 : 00 to 99 : 59 : 59
- By setting the time of the integration timer (see section 6.8 or 6.9) to an integer multiple of the store interval, the integrated values at integration start and integration stop that are repeated according to the time setting of the integration timer can be stored.

#### Setting the Store Reservation Time

- The reservation time is set in units of year : month : date, hour : minute : second.
  - Set the hour : minute : second in the following range.  
00 : 00 : 00 to 23 : 59 : 59
- Make sure the reservation time for stopping the store operation is after the reservation time for starting the store operation.

#### Note

- The reservation time allows up to 31 days to be specified for February. If an erroneous date is specified, an error message is displayed at the time of execution of the store operation (section 11.4). Reset the reservation time in this case.
  - Leap years are recognized at the time of execution of the store operation.
-

# 11.3 Setting the Numerical Data and Waveform Display Data to Be Stored

## Keys

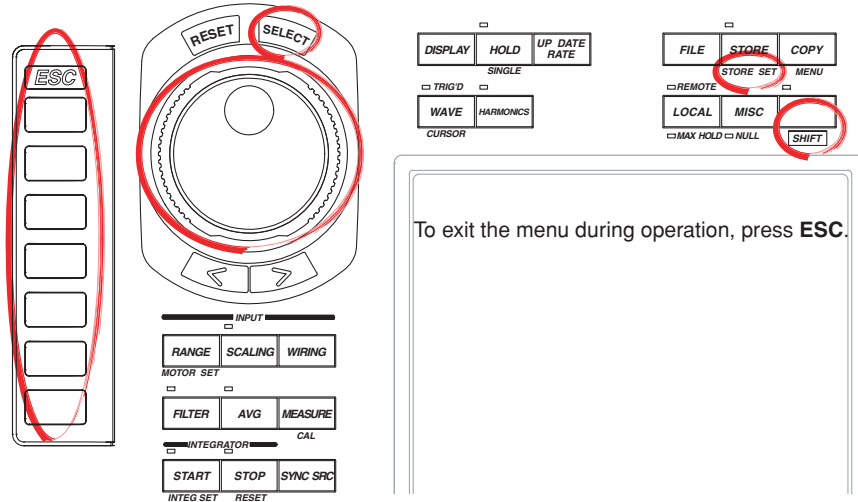

## Procedure

1. Press **SHIFT+STORE (STORE SET)** to display the Store Set dialog box.
2. Press the **Mode** soft key to select Store.
3. Press the **Store Setting** soft key to display the Store Setting dialog box.

### Selecting the Stored Item

4. Press the **Store Item** soft key to display the Store Item dialog box.
5. Press one of the soft keys from **Numeric** to **Numeric+Wave** to select the stored item.
  - If you select Numeric, the stored item is the numerical data.
  - If you select Wave, the stored item is the waveform display data.
  - If you select Numeric+Wave, the stored item is both the numerical data and the waveform display data.

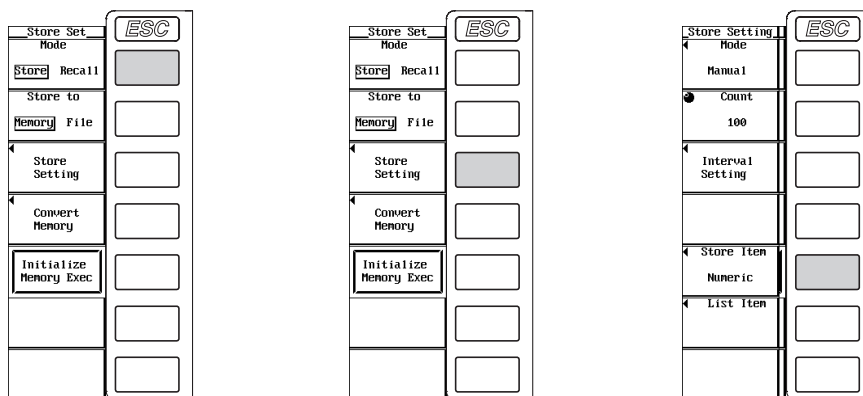

**Selecting the Numerical Data to Be Stored**

(This operation is valid if the stored item was set to Numeric or Numeric+Wave in step 5.)

6. Press the **List Item** soft key to display the List Item dialog box.

- **Selecting all items at once (during normal measurement only)**
- 7. Turn the **jog shuttle** to select All ON.
- 8. Press **SELECT**. The buttons to the left of all the elements and measurement functions are highlighted indicating that all items will be stored.

- **Deselecting all items at once (during normal measurement only)**
- 7. Turn the **jog shuttle** to select All OFF.
- 8. Press **SELECT**. The highlighting of the buttons to the left of all the elements and measurement functions are cleared indicating that all items will not be stored.

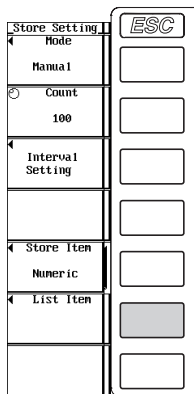

**During normal measurement**

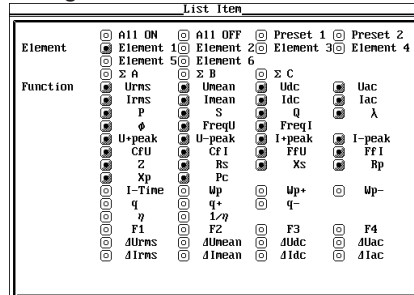

**During harmonic measurement**

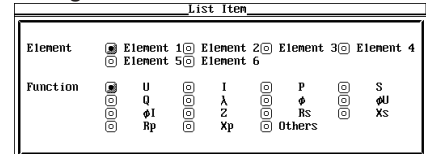

- **Selecting only the items that are preset (during normal measurement only)**
- 7. Turn the **jog shuttle** to select Preset1 or Preset2.
- 8. Press **SELECT**. The buttons to the left of all the elements and measurement functions that are specified in Preset1 or Preset 2 are highlighted indicating that the items will be stored.

**Items specified in Preset1**

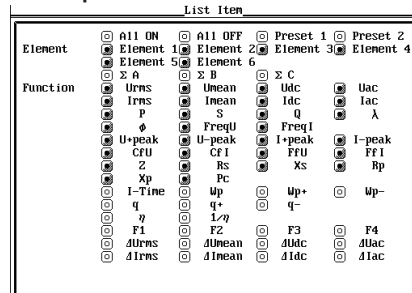

**Items specified in Preset2**

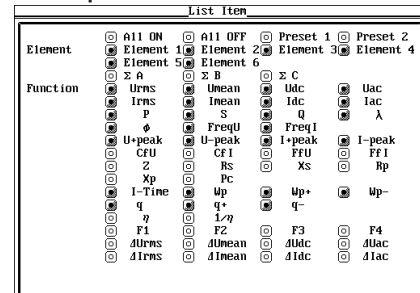

- **Setting the items one at a time**
- 7. Turn the **jog shuttle** to select the element or measurement function that you wish to specify.
- 8. Press **SELECT**. When the button to the left of the selected element or measurement function is highlighted, the numerical data of the measurement function of the element will be stored. When the highlighting of the button is cleared, the numerical data of the measurement function of the element will not be stored.

### 11.3 Setting the Numerical Data and Waveform Display Data to Be Stored

#### Selecting the Waveform Display Data to Be Stored

(This operation is valid if the stored item was set to Wave or Numeric+Wave in step 5.)

6. Press the **Wave Trace** soft key to display the Wave Trace dialog box.

- **Selecting all the items at once**

7. Turn the **jog shuttle** to select All ON.

8. Press **SELECT**. The buttons to the left of all the signals are highlighted indicating that all items will be stored.

- **Deselecting all the items at once**

7. Turn the **jog shuttle** to select All OFF.

8. Press **SELECT**. The highlighting of the buttons to the left of all the signals are cleared indicating that all items will not be stored.

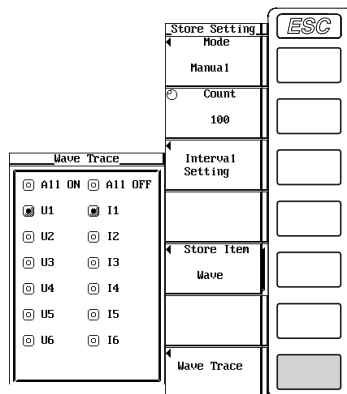

- **Setting the items one at a time**

7. Turn the **jog shuttle** to select the input signal you wish to set.

8. Press **SELECT**. When the button to the left of the selected input signal is highlighted, the input signal will be stored. If the highlighting of the button is cleared, the input signal will not be stored.



**Explanation****Selecting the Items to Be Stored**

Select the item to be stored from the following list of choices.

- Numeric  
Numerical data are stored.
- Wave  
Waveform display data are stored.
- Numeric+Wave  
Numerical data and waveform display data are stored.

**Selecting the Numerical Data to Be Stored**

Select which numerical data items are to be stored.

- **During Normal Measurement**
  - Only installed elements and wiring units are applicable for the selection.
  - The measurement functions that are to be stored can be selected from the items that are indicated in “Measurement Function Types during Normal Measurement” and “Measurement Function Types for Motor Evaluation Function (Option)” in section 1.2; “Delta Computation,” “User-Defined Functions,” and “Corrected Power” in section 1.5; and “Measurement Functions of Integration” in section 1.6.
- **During Harmonic Measurement**
  - Only installed elements are applicable for the selection.
  - The measurement functions that are to be stored can be selected from U (including Uhdf), I (including Ihdf), P (including Phdf), S, Q,  $\lambda$ ,  $\phi$ ,  $\phi U$ ,  $\phi I$ , Z, Rs, Xs, Rp, Xp, and Others\* .
    - \* If Others is selected, the measurement functions Uthd, Ithd, Pthd, Uthf, Ithf, Utif, Itif, hvf, hcf, fU, and fl of the selected elements, phase difference  $\phi$ ,  $\Sigma$  functions, user-defined functions, and so on are stored.

**Selecting the Waveform Display Data to Be Stored**

- Select which waveform display data items are to be stored.
- Only the input signals of the installed elements are applicable for the selection.
- For models with the motor evaluation function (option), the input signals of Speed and Torque are also selectable items.

**Note**

- For the meanings of the measurement function symbols that are displayed, see section 1.2, “Measurement Functions and Measurement Periods,” 1.5, “Computation,” 1.6, “Integration,” appendix 1, “Symbols and Determination of Measurement Functions,” and appendix 2, “Determination of Delta Computation.”
- For details on the wiring units expressed as  $\Sigma A$ ,  $\Sigma B$ , and  $\Sigma C$ , see section 5.1, “Selecting the Wiring System.”
- [-----] (no data) is stored in places where there is no numerical data.
- If there are no integrated values because integration is not performed, [-----] (no data) is stored. The integration time is stored along with [-----].
- The maximum harmonic for which the data is stored is the upper limit of harmonic order under analysis that is specified in section 7.5. [-----] (no data) is stored for harmonic orders without data.

# 11.4 Storing the Data

## Keys

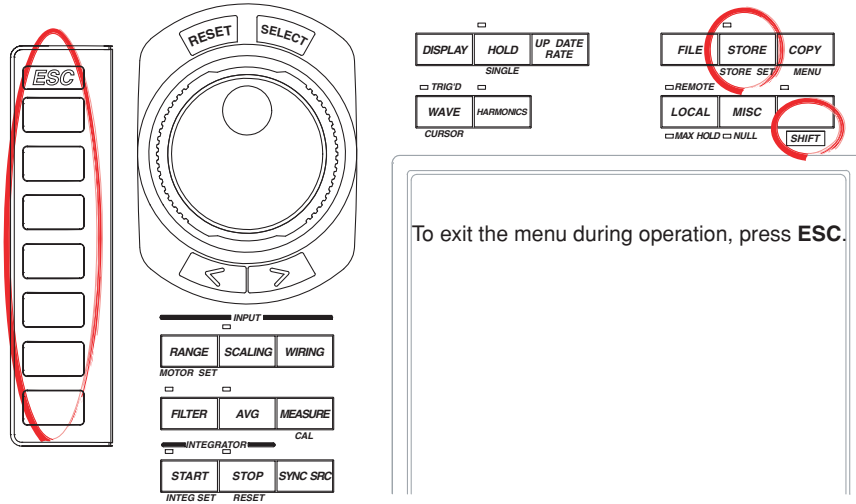

## Procedure

### Initializing (Clearing) the Internal Memory

1. Press **SHIFT+STORE (STORE SET)** to display the Store Set dialog box.
2. Press the **Mode** soft key to select Store.
3. Press the **Store to** soft key to select Memory.
4. Press the **Initialize Memory Exec** soft key to display the Alert dialog box.
5. Turn the **jog shuttle** to select OK or Cancel.
6. If you select OK and press **SELECT**, the data in the internal memory is cleared. If you select Cancel and press **SELECT**, the clearing of the data in the internal memory is aborted.

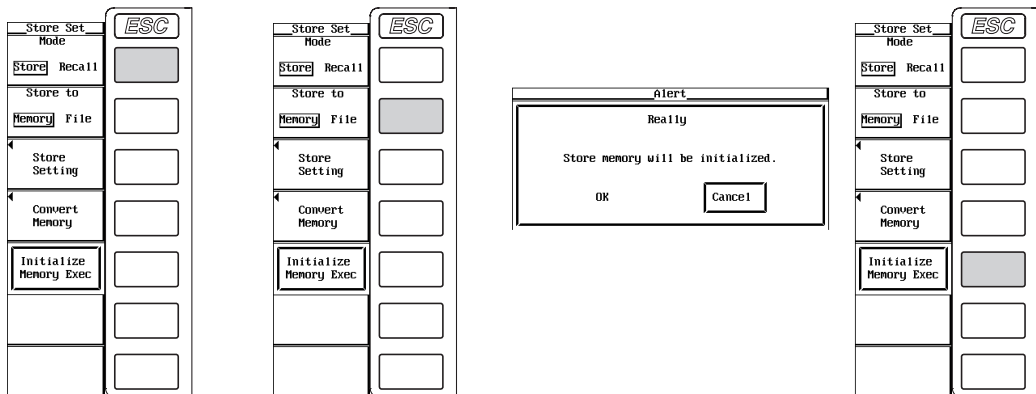

### Starting the Store Operation

7. Press **STORE**. The STORE indicator above and to the left of the key illuminates. The store operation starts according to the following conditions depending on the store mode (see section 11.1).
  - During manual mode  
Starts the store operation. When STORE is pressed, the first store operation is executed. "Store:Start" is displayed at the upper left corner of the screen.
  - During real-time mode  
The instrument enters the store ready condition and "Store:Ready" is displayed at the upper left corner of the screen. The store operation starts at the reservation time for starting the operation. When the reservation time for starting the store operation is reached, the first store operation is executed. "Store:Start" is displayed at the upper left corner of the screen.
  - During integration synchronization mode  
The instrument enters the store ready condition and "Store:Ready" is displayed at the upper left corner of the screen. When integration starts, the store operation starts. When integration starts, the first store operation is executed. "Store:Start" is displayed at the upper left corner of the screen.

### Stopping the Store Operation

8. If the store operation is in progress, pressing **STORE** again stops the operation. The STORE indicator above and to the left of the key turns off.

### Automatically Stopping the Store Operation

8. The store operation stops automatically according to the following conditions depending on the store mode. The STORE indicator above and to the left of the key turns off.
  - During manual mode  
The store operation stops when the specified store count of data is stored or when the data is stored up to the internal memory size (approximately 12 MB, or approximately 11 MB when using a WT1600 with ROM version 2.01 or later). "Store:Stop" is displayed at the upper left corner of the screen.
  - During real-time mode  
The store operation stops when the specified store count of data is stored, when the reservation time for stopping the store operation is reached, or when the data is stored up to the internal memory size. "Store:Stop" is displayed at the upper left corner of the screen.
  - During integration synchronization mode  
The store operation stops when the specified store count of data is stored, when integration stops, or when the data is stored up to the internal memory size. "Store:Stop" is displayed at the upper left corner of the screen.

### Explanation

To store data, parameters such as the store mode, the store count, the store interval, and the store reservation time must be specified before executing the operation. This section explains the start and stop operations of storage. For the procedure on how to set the store mode, see section 11.1; for the procedure on how to set the store count, the store interval, and the store reservation time, see section 11.2.

#### Initializing (Clearing) the Internal Memory

- Store operation can be executed only when the internal memory is cleared.
- If you are performing the first store operation after turning ON the power switch, there is no need to clear the internal memory.

#### Starting the Store Operation

The store operation starts according to various conditions depending on the store mode (see section 11.1). For details, see the procedural explanation.

#### Stopping the Store Operation

- The store operation can be forcibly stopped using the STORE key.
- The store operation stops automatically according to the various conditions depending on the store mode. For details, see the procedural explanation.

#### Saving the Stored Data

The data stored to the internal memory cannot be held by means of the internal lithium battery. The data in the internal memory is lost when the power to the WT1600 is turned OFF. If you wish to keep the data, save the data to a storage medium before turning OFF the power.

#### Note

---

- To start the store operation again after stopping the operation, the internal memory must be cleared.
  - [-----] (no data) is stored in places where there is no numerical data.
  - If there are no integrated values because integration is not performed, [-----] (no data) is stored. The integration time is stored along with [-----].
  - The maximum harmonic for which the data is stored is the maximum harmonic order to be analyzed that is specified in section 7.5. [-----] (no data) is stored for harmonic orders without data.
  - While the store operation is in progress, you cannot turn ON/OFF the harmonic measurement mode or change the PLL source, the equation for distortion, scaling, averaging, filter, integration mode, integration timer, or the store interval.
  - If you press HOLD to hold the display while the store operation is in progress, the value that existed when HOLD was pressed is stored.
  - If you press HOLD to hold the display while storing data with the store interval is 00:00:00, the store operation stops.
-

# 11.5 Saving the Stored Data

## Keys

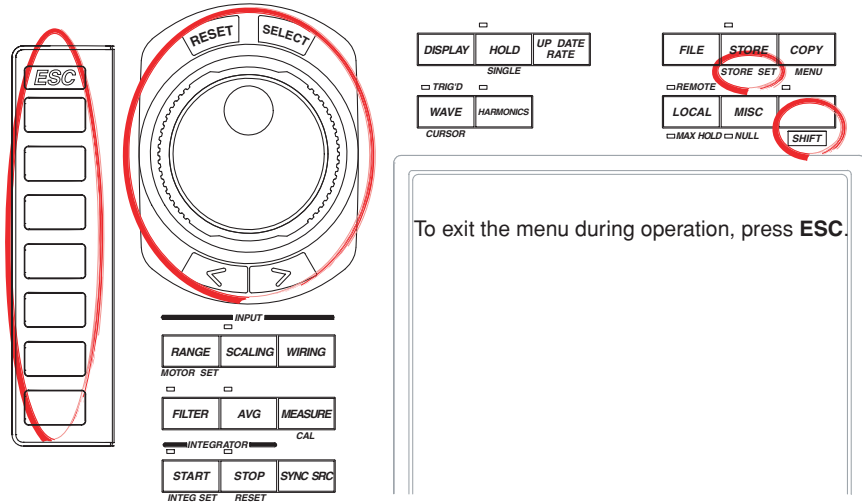

## Procedure

1. Press **SHIFT+STORE (STORE SET)** to display the Store Set dialog box.
2. Press the **Mode** soft key to select Store.
3. Press the **Store to** soft key to select Memory or File.  
 If you selected Memory, proceed to "When Saving Data That Has Already Been Stored" on the next page.  
 If you selected File, proceed to "When Saving Data through a Store-and-Save Operation Sequence" on page 11-16.

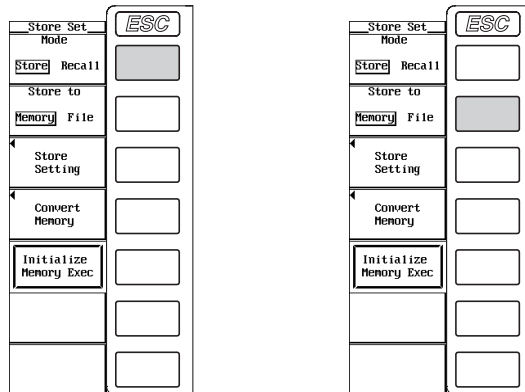

### When Saving Data That Has Already Been Stored

- Press the **Convert Memory** soft key to display the Convert Memory dialog box.

#### Selecting the Data Type for Saving the Data

- Press the **Data Type** soft key to select ASCII or Float.

#### Selecting the Save Destination Medium

- Press the **File List** soft key to display the File List dialog box.
- Turn the **jog shuttle** to select the save destination medium (indicated by [ ]).
- Press **SELECT** to confirm the new medium.

#### Selecting the Save Destination Directory

(Perform this operation when directories are present on the medium.)

- Turn the **jog shuttle** to select the save destination directory (indicated by < >).
  - Press **SELECT** to confirm the new directory.
- The selected medium/directory is displayed in “Path=.....” located at the upper left corner of the File List dialog box.

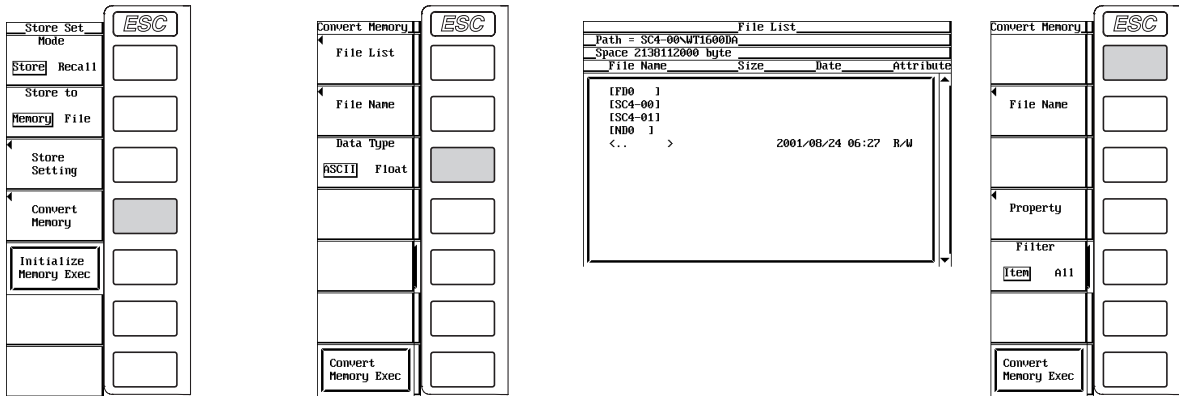

#### Setting the File Name and Comment

- Press the **File Name** soft key to display the Save dialog box.
- Turn the **jog shuttle** to select Auto Naming.
- Press **SELECT** to select ON or OFF.
- Turn the **jog shuttle** to select File Name.
- Press **SELECT** to display the keyboard.
- Use the **keyboard** to set the file name.

For keyboard operations, see section 3.12, “Entering Values and Strings.”

- Enter the **comment** in a similar fashion.
- Press **ESC** to close the Save dialog box.

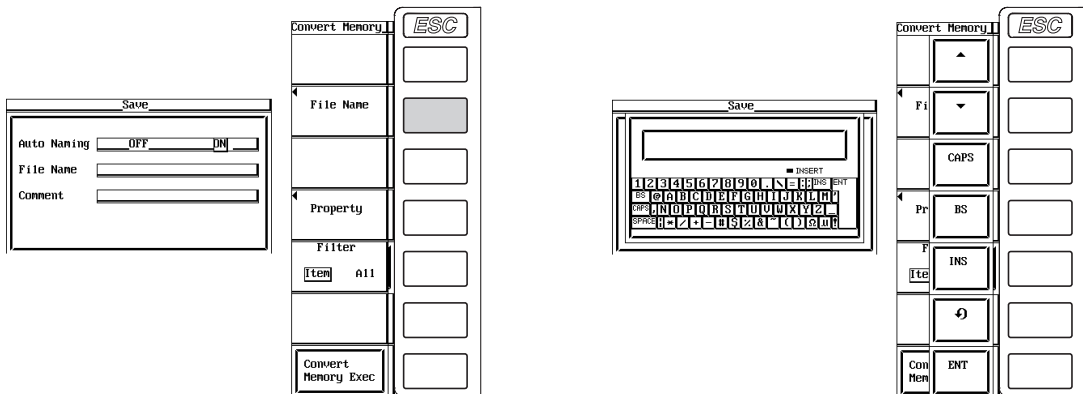

**Executing the Save Operation**

- Press the **Convert Memory Exec** soft key. The stored data is saved to the directory indicated by Path=..... At the same time, the Convert Memory Exec soft key changes to an Abort soft key.

**Aborting the Save Operation**

- Press the **Abort** soft key to abort the save operation. At the same time, the Abort soft key changes to a Convert Memory Exec soft key.

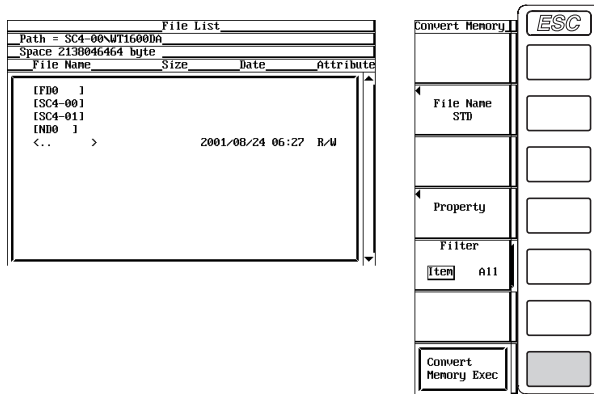

**Specifying the File to Be Displayed on the File List Dialog Box**

- Press the **Filter** soft key to select Item or All.

**Viewing the Properties**

- On the File List dialog box, turn the **jog shuttle** to select the file.
- Press the **Property** soft key to display the file property window.
- Press **ESC** to close the file property window.

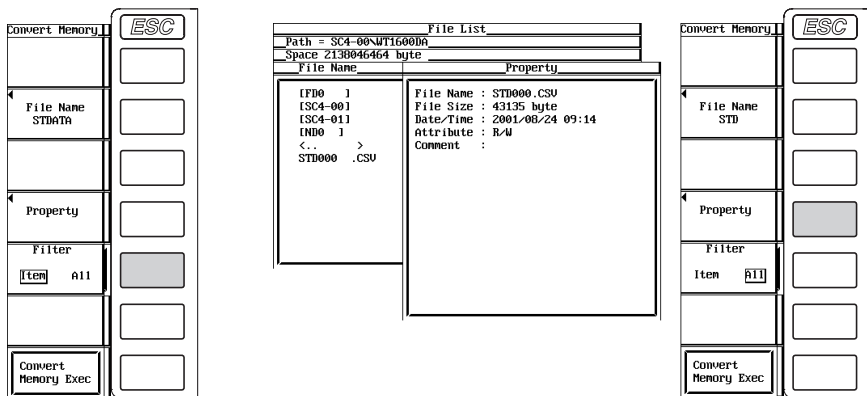

### When Saving Data through a Store-and-Save Operation Sequence

4. Press the **File setting** soft key to display the File setting dialog box.

#### Selecting the Data Type for Saving the Data

5. Same as step 5 under “Selecting the Data Type for Saving the Data” on page 11-14.

#### Selecting the Save Destination Medium

6. Same as steps 6 to 8 under “Selecting the Save Destination Medium” on page 11-14.

#### Selecting the Save Destination Directory

7. Same as steps 9 and 10 under “Selecting the Save Destination Directory” on page 11-14.

#### Setting the File Name and Comment

8. Same as steps 11 to 18 under “Setting the File Name and Comment” on page 11-14.

#### Initializing (Clearing) the Internal Memory

9. Press **ESC** twice to return to the Store Set menu.
10. Press the **Initialize Memory Exec** soft key to display the Alert dialog box.
11. Turn the **jog shuttle** to select OK or Cancel.
12. If you select OK and press **SELECT**, the data in the internal memory is cleared. If you select Cancel and press **SELECT**, the clearing of the data in the internal memory is aborted.

#### Starting the Store Operation

13. Press **STORE**. The store operation starts (see section 11.4) according to various conditions depending on the store mode (see section 11.1).

#### Stopping the Store Operation and Saving the Data

14. If the store operation is in progress, pressing **STORE** again stops the operation. Then, the stored data is saved to the directory indicated by Path=.....

#### Automatically Stopping the Store Operation and Saving the Data

15. The store operation stops (see section 11.4) automatically according to the various conditions depending on the store mode. Then, the stored data is saved to the directory indicated by Path=.....

#### Specifying the File to Be Displayed on the File List Dialog Box

Same as step 11 under “Specifying the File to Be Displayed on the File List Dialog Box” on page 11-15.

#### Viewing the Properties

Same as steps 11 to 13 under “Viewing Properties” on page 11-15.

#### Note

---

- If the medium at the save destination does not exist when saving the stored data, an error message is displayed and the save operation is aborted. Since the data is stored in the internal memory in this case, you can save the data stored to the memory by selecting “Memory” according to step 3 on page 11-13 and then carrying out the steps on given on pages 11-14 and 11-15.
  - Since filing operations are not possible during the integration operation condition, do not perform the store-and-save operation sequence while in integration synchronization mode. Also, data that are stored cannot be saved during the integration operation condition.
-



## Explanation

**CAUTION**

Do not remove the medium (disk) or turn OFF the power when the access indicator or  is blinking. Such acts can damage the medium or destroy the data on the medium.

**Selecting the Data Type**

Select the data type from the following list of choices. The extension is automatically added.

- ASCII
  - Numerical data or waveform display data is saved in ASCII format.
  - The file can be used on your PC for analysis.
  - The file cannot be loaded to the WT1600.
- Float
  - Numerical data or waveform display data is saved in 32-bit floating format.
  - The file cannot be loaded to the WT1600.

**Extension and Data Size of the Numerical Data File**• **During normal measurement**

Data Type	Extension	Data Size (Bytes)
ASCII	.CSV	Approx. 7 K (condition: number of elements 1, store all measurement functions 10 times.)
Float	.WTD	When integration is not performed Approx. $(4 K + (4 \times D_n + 16) \times \text{store count})$ When integration is performed Approx. $(4 K + (4 \times D_n + 16 + 16 \times T_i) \times \text{store count})$ $D_n$ : Number of numerical data to be stored (Number of measurement functions $\times$ (number of elements + number of wiring units)) $T_i$ : Number of integration time to be stored

• **During harmonic measurement**

Data Type	Extension	Data Size (Bytes)
ASCII	.CSV	Approx. 25 K (condition: number of elements 1, measurement functions U and Others, maximum order* 100, store 10 times)
Float	.WTD	Approx. $(4 K + (4 \times D_n + 16) \times \text{store count})$ $D_n$ : Number of numerical data to be stored <ul style="list-style-type: none"> <li>• When U, I, or P is stored: Number of elements <math>\times</math> maximum order* <math>\times 2</math></li> <li>• When S to Xp are stored: Number of elements <math>\times</math> maximum order*</li> <li>• When Others are stored: Number of elements <math>\times 11 + 21</math></li> </ul>

\* The maximum + 2 (Total, dc) harmonic order to be analyzed as specified in section 7.5.

**Extension and Data Size of the Waveform Display Data File**• **During normal measurement**

Data Type	Extension	Data Size
ASCII	.CSV	Approx. 103 K (condition: when one waveform is to be stored)
Float	.FLD	Approx. $(4 K + (4 \times 1002 \times T_w + 16) \times \text{store count})$ $T_w$ : Number of waveforms to be stored

• **During harmonic measurement**

Same as for normal measurement.

### Selecting the Medium and Directory

Media on which saving and reading is possible are displayed on the File List dialog box.

#### Display Example of a Medium

[FD0]: Floppy disk

[SC4]: SCSI device whose ID number is 4 (built-in hard disk, fixed to ID4)

[SC5]: SCSI device whose ID number is 5 (see section 12.3)

[SC5\_01]: Partition 1 of a SCSI device whose ID number is 5

[ND0]: Network drive (see section 13.3)

### File Name and Comment

- A file name must be assigned. Comments are optional.
- You cannot save to a file name that already exists in the same directory (overwriting not allowed).

### Number of Characters and Types That Can Be Used

Item	Number of Characters	Characters That Can Be Used
File name	1 to 8 characters	0-9, A-Z, %, _ ( ) (parenthesis), - (minus sign)
Comment	0 to 25 characters	Characters that are displayed on the keyboard and spaces

### Auto Naming Function

When Auto Naming is turned ON, files with a three digit number from 000 to 999 are automatically created when saving the data. You can specify a common name (up to five characters, specified through Filename) that is placed before the number.

### Initializing (Clearing) the Internal Memory

- Store operation can be executed only when the internal memory is cleared.
- If you are performing the first store operation after turning ON the power switch, there is no need to clear the internal memory.

### Specifying the File to Be Displayed on the File List Dialog Box

Specify the type of files to be displayed.

- Item  
Displays only the numerical data and waveform display data files in the selected directory.
- All  
Displays all the files in the selected directory.

**Properties**

Displays the filename.extension, the file size, the date the file was saved, the attribute, and the comment of the selected file.

**Note**

- 
- The following data is stored in the places where numerical data does not exist when saving the stored numerical data.
    - For ASCII files: Characters NAN, +INF, -INF, or ERROR.
    - For Float files: 0x7FC00000, 0x7F800000, 0xFF800000, or 0xFFFFFFFFE.
  - Up to 36 characters can be displayed in Path.
  - The file names are not case-sensitive. Comments are case-sensitive. In addition, the following five file names cannot be used due to limitations of MS-DOS.  
AUX, CON, PRN, NUL, and CLOCK
  - When using the GP-IB or serial interface commands to enter a file name, the following symbols that do not exist on the keyboard of this instrument can be used.  
{ }
-

## 11.6 Recalling the Stored Data

### Keys

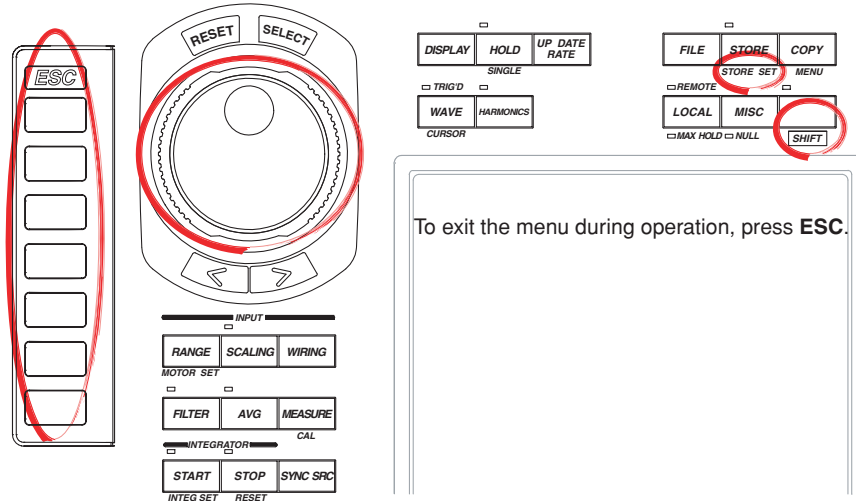

### Procedure

1. Press **SHIFT+STORE (STORE SET)** to display the Store Set dialog box.
2. Press the **Mode** soft key to select Recall.
3. Turn the **jog shuttle** and set the Recall No. (number of the data to be recalled).  
The corresponding data is displayed.

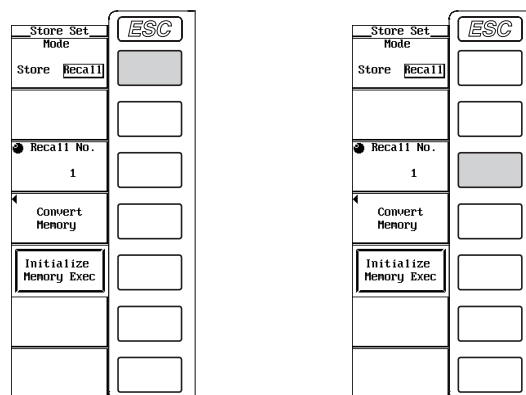

### Explanation

You can recall and display the stored numerical data or waveform display data. There is a one-to-one relationship between the store count number (see section 11.2) and the Recall No. If you wish to recall the first stored data, for example, set Recall No. to 1.

### Note

Only the data stored to the internal memory can be recalled.

## 12.1 Precautions to Be Taken When Using the Floppy Disk Drive

### Floppy Disks That Can Be Used

The 3.5" floppy disks below can be used. You can format the disk on the WT1600.  
2HD: 1.44 MB MS-DOS format

### Inserting the Floppy Disk into the Floppy Disk Drive

With the label facing up, insert the disk from the side with the shutter. Insert the disk until the eject button pops out.

### Removing the Disk from the Floppy Disk Drive

Check that the access indicator is turned OFF and press the eject button.

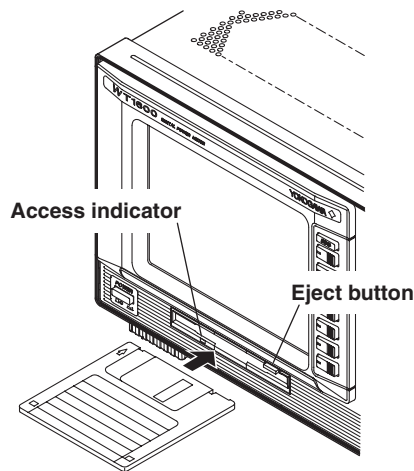

### CAUTION

Do not remove the floppy disk drive when the access indicator or  is blinking. Such act can damage the magnetic head of the floppy disk drive or destroy the data on the disk.

### General Handling Precautions of Floppy Disks

For the general handling precautions of the floppy disk, read the instruction manual that came with the floppy disk.

## 12.2 Built-in Hard Disk (Option)

### Keys

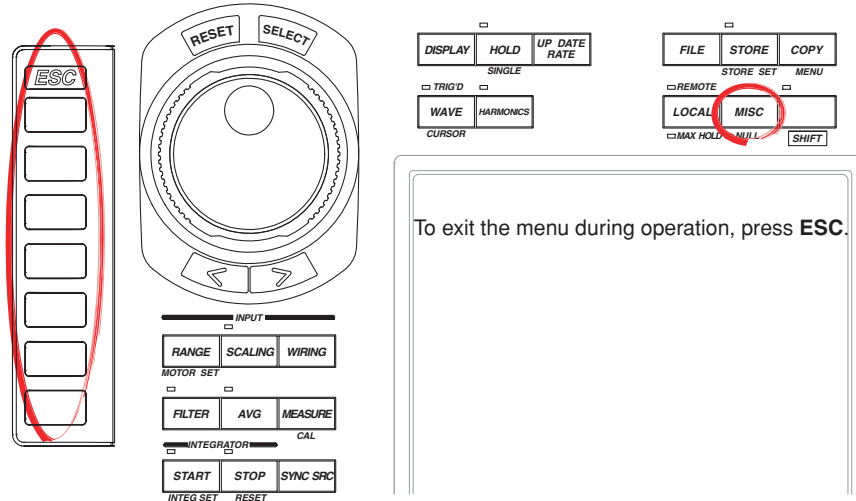

### Procedure

1. Press **MISC** to display the Misc menu.
2. Press the **Next 1/2** soft key to display the Next 2/2 menu.
3. Press the **SCSI Setting** soft key to display the SCSI Setting dialog box.
4. Press the **HDD Motor** soft key to select ON or OFF.

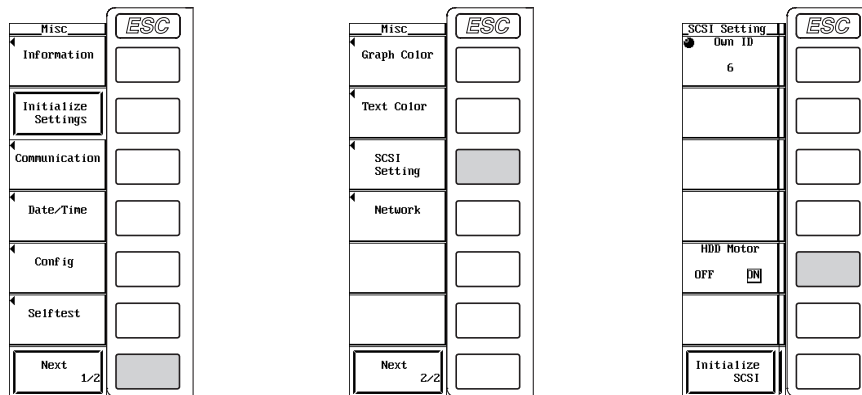

### Explanation

- You can turn ON/OFF the power to the built-in hard disk on this instrument. By turning the power OFF, you can protect the built-in hard disk from vibrations.
- The SCSI ID of the built-in hard disk is fixed to 4.
- The size of the built-in hard disk is approximately 10 GB. The disk is formatted with 5 partitions before being shipped from the factory.

### CAUTION

- Do not turn OFF the power while the built-in hard disk is being accessed. Such act can damage the data on the hard disk.
- When using the instrument in a vibrating environment, turn OFF the motor power of the built-in hard disk.

## 12.3 Connecting a SCSI Device

### SCSI (Option) Specifications

Item	Specification
Interface standard	SCSI (Small Computer System Interface), ANSI X3.131-1986
Connector type	Half pitch 50 pins (pin type)
Electrical specifications	Single end. See the figure below for the pin configuration. Terminator is built in.

Pin No.	Signal Name	Pin No.	Signal Name
1 to 12	GND	38	TERMPWR
13	NC	39, 40	GND
14 to 25	GND	41	-ATN
26	-DB0	42	GND
27	-DB1	43	-BSY
28	-DB2	44	-ACK
29	-DB3	45	-RST
30	-DB4	46	-MSG
31	-DB5	47	-SEL
32	-DB6	48	-C/D
33	-DB7	49	-REQ
34	-DBP	50	-I/O
35 to 37	GND	—	—

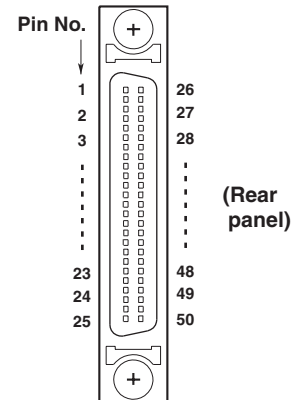

### Items Necessary for Connection

#### Cable

Use a commercially sold cable that is 3 m or less in length, that has a ferrite core on each end of the cable, and that has a characteristic impedance between 90 and 132  $\Omega$ .

### Procedure When Connecting the WT1600 and a SCSI Device

1. Connect the SCSI cable to the SCSI connector on the rear panel of the instrument.
2. Turn ON the SCSI device first and then the WT1600.  
To format the hard disk, follow the procedure described in the section 12.5, "Formatting the Disk."

#### Connectable SCSI Devices

Most SCSI devices (MO disk drive, hard disk, and ZIP) can be connected to the instrument, but there are some exceptions. For example, the maximum number of partitions that can be selected is 10 and each partition cannot exceed 2 GB. If the total capacity of all partitions exceeds 20 GB, the hard disk cannot be formatted. For details on which devices can be connected, ask your YOKOGAWA dealer. For general handling precautions for the connected SCSI device, see the instruction manual that is provided with the device.

#### Note

When connecting multiple SCSI devices in a chain, attach a SCSI terminator to the device at the other end of the chain.





**Explanation**

The SCSI ID number is used to distinguish between the various devices connected to the SCSI chain. Make sure not to use duplicate ID numbers on any of the connected devices. The SCSI is optional.

**Selectable Range of SCSI ID Numbers for the WT1600**

Own ID can be set in the range of 0 to 7. The default value is 6.

**SCSI ID Number of the Built-in Hard Disk**

Fixed to 4.

**Note**

- 
- Do not set the SCSI ID number of the external SCSI device to the same ID number as the built-in hard disk of the WT1600.
  - When changing the SCSI ID number, make sure to press the Initialize SCSI soft key.
  - The SCSI ID numbers of external SCSI devices are automatically detected.
-

# 12.5 Formatting the Disk

## Keys

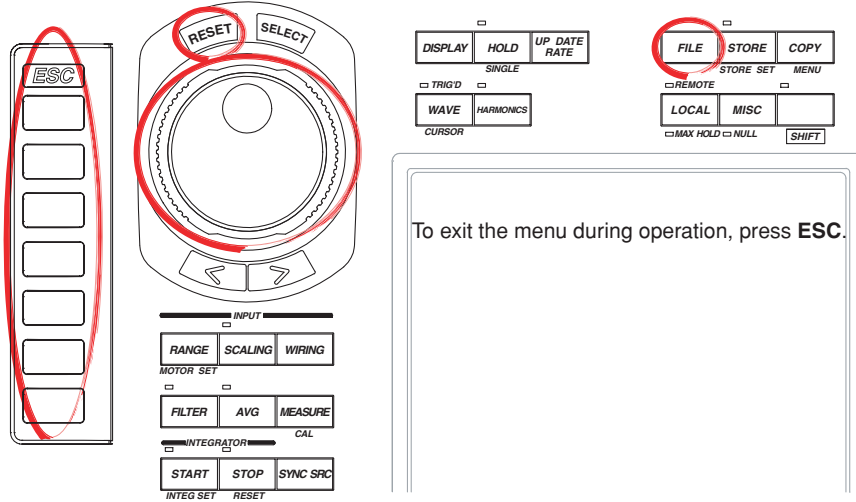

To exit the menu during operation, press **ESC**.

## Procedure

1. Press **FILE** to display the File menu.
2. Press the **Utility** soft key. The Utility menu and the File List dialog box appear.
3. Press the **Function** soft key to display the Function menu.

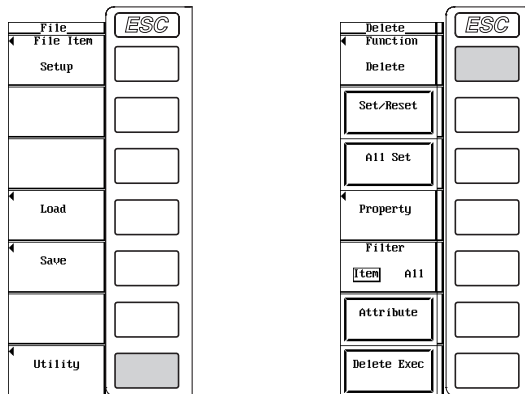

**Selecting the Medium to Be Formatted**

4. Press the **Format** soft key. The media list is displayed in the File List dialog box.
5. Turn the **jog shuttle** to select the medium to be formatted.  
 If there are no external SCSI devices that are detected and only a floppy disk is inserted in the floppy drive, only [FD0] appears.

**Viewing the Media Information**

6. Press the **Media Info** soft key. The information about the medium that was selected in step 5 is displayed.  
 If you selected FD0 in step 5, proceed to step 7 below.  
 If you selected SC.. in step 5, proceed to step 7 on the next page.

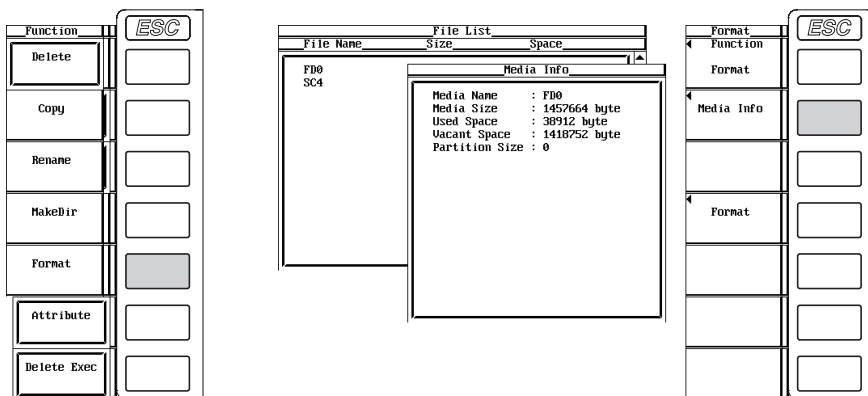

**Selecting the Floppy Disk Format**

7. Press the **Format** soft key to display the Format menu. Proceed to step 10.

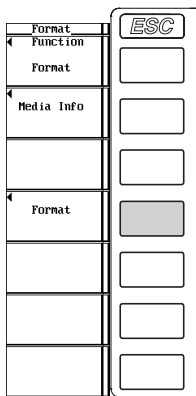

**Selecting the Medium Format of the SCSI Device**

7. Press the **Format** soft key to display the Format menu.

- **Selecting the number of partitions**

8. Turn the **jog shuttle** to select a value from 1 to 10.

- **Selecting the format type**

9. Press the **Format Type** soft key to select Normal or Quick.

For models with firmware version 1.06 or later, if you select SC4 (internal hard disk), this menu is not displayed. Only a logical format (Quick) is performed.

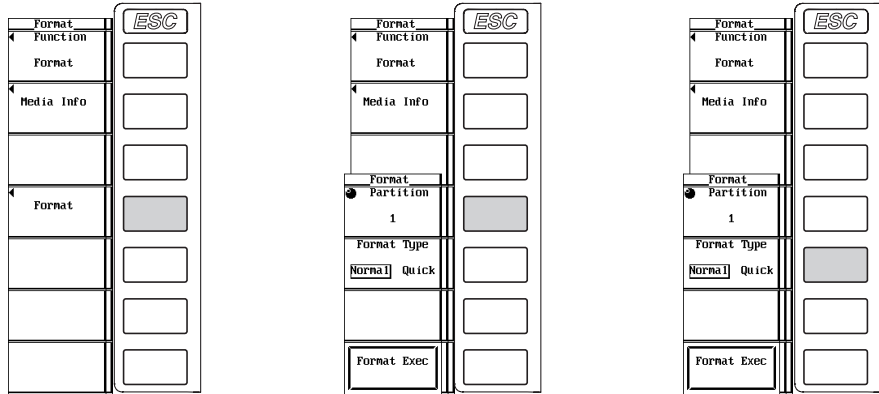

**Executing (OK)/Aborting (Cancel) the Format Operation**

10. Press the **Format Exec** soft key to display the Alert dialog box.

11. Turn the **jog shuttle** to select OK or Cancel.

12. Select OK and press **SELECT** to execute the format operation.

Select Cancel and press **SELECT** to abort the format operation.

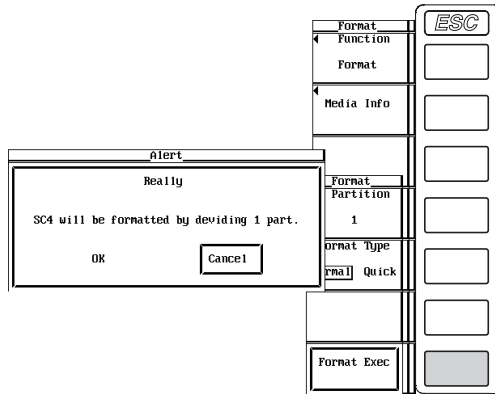

**Explanation****CAUTION**

- Do not remove the medium (disk) or turn OFF the power when the access indicator or  is blinking. Such acts can damage the medium or destroy the data on the medium.
- If the WT1600 cannot recognize a formatted medium, format the disk again on the WT1600. Note that all the data on the disk are cleared when the disk is formatted. Make sure to back up important data beforehand.

**Media Information**

Lists the information about the selected medium.

- Media Name: Name of the medium.
- Media Size: Total size.
- Used Space: Size of the used area.
- Vacant Space: Size of the free area.
- Partition Size: Number of partitions.

If you press the Media Info soft key when a floppy disk that has been formatted to MS-DOS format is inserted in the floppy drive, the media information of the floppy disk is displayed.

**Formatting a Floppy Disk**

When using a new floppy disk, you must format it. The format is 2 HD 1.44 MB/18 sectors.

**Formatting a Disk**

The formats of the disk that are connected via the SCSI (option) are as follows:

- MO/PD  
Semi-IBM format. It is handled as a removable disk.
- Zip/JAZ  
Hard disk format. It is handled as a fixed disk.

**Formatting a Hard Disk**

IBM-compatible format.

### Selecting the Format Type

When formatting an external SCSI device, you can select the format type from the following list of choices.

- Normal  
Performs both physical format and logical format.
- Quick  
Performs only a logical format.

The approximate time required for the format operation are indicated below (the time varies depending on the SCSI device).

Media	Normal	Quick
MO (128 MB)	Approx. 10 minutes	Approx. 15 s
MO (230 MB)	Approx. 10 minutes	Approx. 15 s
External HDD (10 GB)	Approx. 15 minutes	Approx. 15 s
Built-in hard disk	Approx. 15 minutes	Approx. 10 s
Built-in hard disk	—	Approx. 10 s

(For models with firmware version 1.06 or later)

### Selecting the Number of Partitions

- The external hard disk can be divided into several partitions.
- Select the number of partitions in the range from 1 to 10. If the number of partitions is set to “2,” the hard disk is divided into two partitions named “SC0” and “SC1.”
- When formatting a large hard disk, select the number of partitions so that each partition does not exceed 2 GB.
- If the total capacity of all partitions exceeds 20 GB, the hard disk cannot be formatted.
- The selection of the number of partitions only applies to a hard disk. For all other media, it is handled as one partition.

### Note

---

- If you format a medium that has data stored on it, all the data are cleared when the medium is formatted.
  - It takes approximately a minute and a half to format a floppy disk.
  - You cannot format a floppy disk if the write-protect is ON.
  - Do not format a disk while the WT1600 and a PC is connected via a SCSI cable.
  - Floppy disks that are formatted to formats other than those listed in this section cannot be used.
  - If an error message is displayed after the format operation, the floppy disk may be damaged.
  - You can use floppy disks that are formatted using MS-DOS on a PC.
  - Quick (logical) format only clears (initializes) information such as directory entries and FAT. If you need to check for bad tracks, perform a physical format (Normal).
  - If data is written to an external SCSI device when there are bad tracks, an access error (604 Media failure) may occur preventing additional data to be written. It is recommended that Normal be used when a medium is formatted for the first time after purchase or a medium that can no longer be read or written and that Quick be used on a medium you have been using before.
  - The WT1600 can perform Quick format of DVD-RAM. Physical format (Normal) is not possible.
-

# 12.6 Saving Setup Parameters, Waveform Display Data, and Numerical Data

## Keys

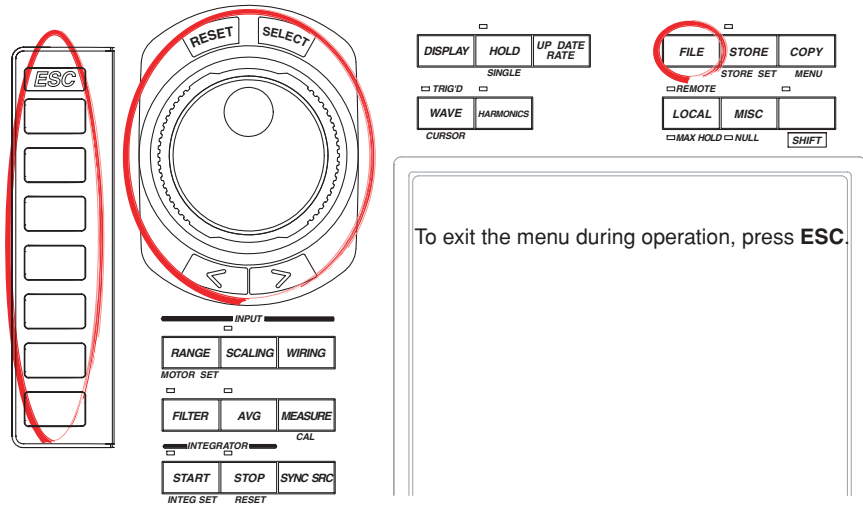

## Procedure

1. Press **FILE** to display the File menu.

### Selecting the Item to Be Saved

2. Press the **File Item** soft key to display the File Item menu.
3. Press one of the soft keys from **Setup to Numeric** to select the item to be saved.
  - If you selected Setup, proceed to step 11 under “Executing/Aborting the Save Operation” on page 12-14.
  - If you selected Wave, proceed to “Selecting the Waveform Display Data” on the next page.
  - If you selected Numeric, proceed to “Selecting the Numerical Data” on the 12-13.

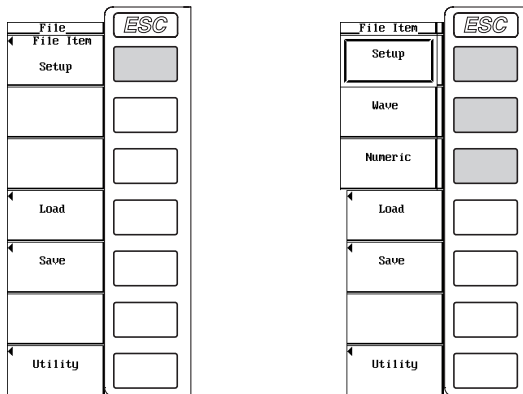

### Selecting the Waveform Display Data

#### Selecting the Type of Waveform Display Data to Be Saved

4. Press the **Data Type** soft key to display the Data Type menu.
5. Press one of the keys from **Binary** to **Float** to select the data type.

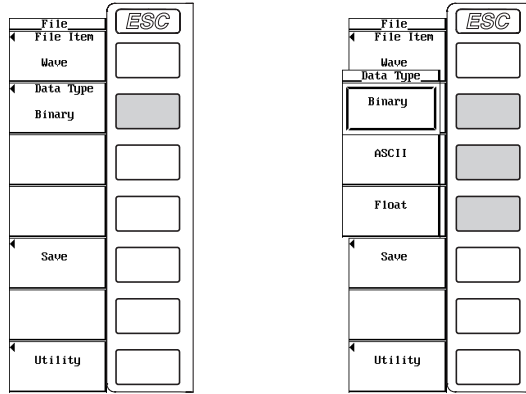

#### Selecting the Input Signals to Be Saved

The input signal selection box appears only when you select Float in step 5. (When the data type is set to Binary or ASCII, the waveform that is displayed on the screen is saved.)

6. Press the **Save** soft key to display the Save Menu menu.
7. Press the **Trace** soft key to display the input signal selection box.
8. Turn the **jog shuttle** to select any of the signals starting with U1.
9. Press **SELECT** to select the input signal to be saved.

Proceed to step 12 on page 12-14.

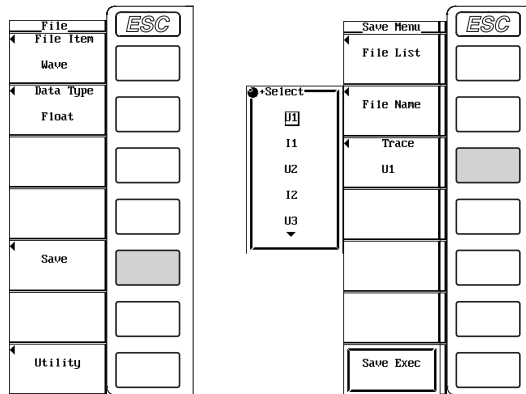



### Selecting the Numerical Data

#### Selecting the Type of Numerical Data to Be Saved

- Press the **Data Type** soft key to select ASCII or Float.

#### Selecting the Numerical Data to Be Saved

- Press the **List Item** soft key to display the List Item dialog box.

- Selecting all items at once (during normal measurement only)**
  - Turn the **jog shuttle** to select All ON.
  - Press **SELECT**. The buttons to the left of all the elements and measurement functions are highlighted indicating that all items will be saved.
- Deselecting all items at once (during normal measurement only)**
  - Turn the **jog shuttle** to select All OFF.
  - Press **SELECT**. The highlighting of the buttons to the left of all the elements and measurement functions are cleared indicating that all items will not be saved.

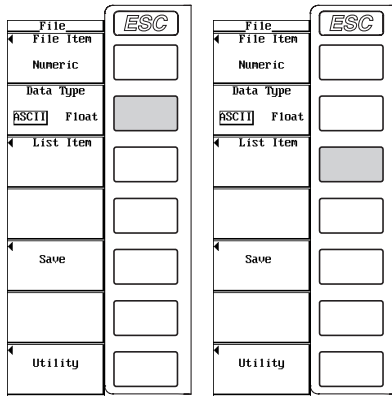

During normal measurement

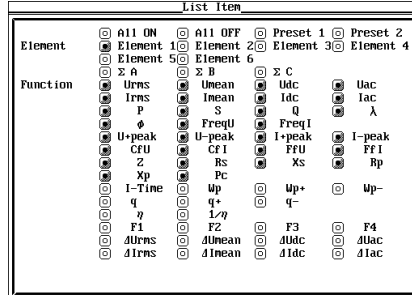

During harmonic measurement

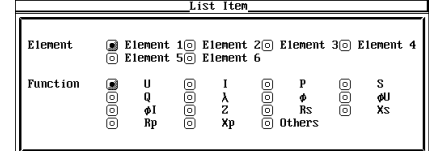

- Selecting only the items that are preset (during normal measurement only)**
  - Turn the **jog shuttle** to select Preset1 or Preset2.
  - Press **SELECT**. The buttons to the left of all the elements and measurement functions that are specified in Preset1 or Preset 2 are highlighted indicating that the items will be saved.

Items specified in Preset1

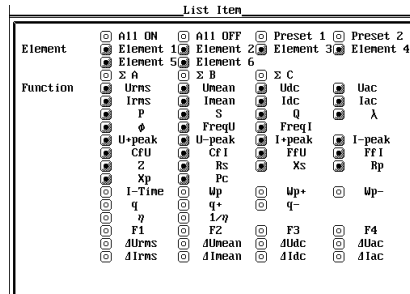

Items specified in Preset2

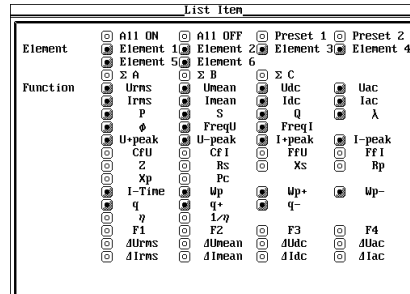

## 12.6 Saving Setup Parameters, Waveform Display Data, and Numerical Data

- **Setting the items one at a time**

- Turn the **jog shuttle** to select the element or measurement function that you wish to specify.
- Press **SELECT**. When the button to the left of the selected element or measurement function is highlighted, the numerical data of the measurement function of the element will be saved. When the highlighting of the button is cleared, the numerical data of the measurement function of the element will not be saved.

Proceed to step 10.

### Executing/Aborting the Save Operation

- Press **ESC** to close the List Item dialog box.
- Press the **Save** soft key to display the Save Menu menu.
- Press the **File List** soft key to display the File List dialog box.

#### Selecting the Save Destination Medium

- Turn the **jog shuttle** to select the save destination medium (indicated by [ ]).
- Press **SELECT** to confirm the new medium.

#### Selecting the Save Destination Directory

(Perform this operation when directories are present on the medium.)

- Turn the **jog shuttle** to select the save destination directory (indicated by < >).
- Press **SELECT** to confirm the new directory.

The selected medium/directory is displayed in “Path=.....” located at the upper left corner of the File List dialog box.

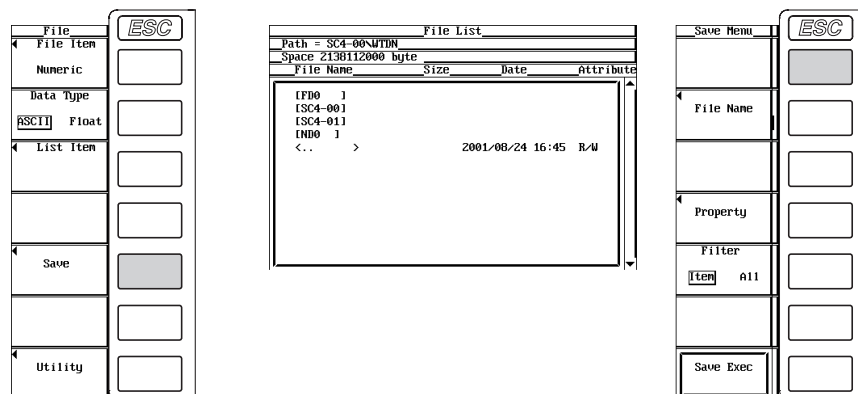

#### Setting the File Name and Comment

- Press the **File Name** soft key to display the Save dialog box.
- Turn the **jog shuttle** to select Auto Naming.
- Press **SELECT** to select ON or OFF.
- Turn the **jog shuttle** to select File Name.
- Press **SELECT** to display the keyboard.
- Use the **keyboard** to set the file name.  
For keyboard operations, see section 3.12, “Entering Values and Strings.”
- Enter the **comment** in a similar fashion.
- Press **ESC** to close the Save dialog box.

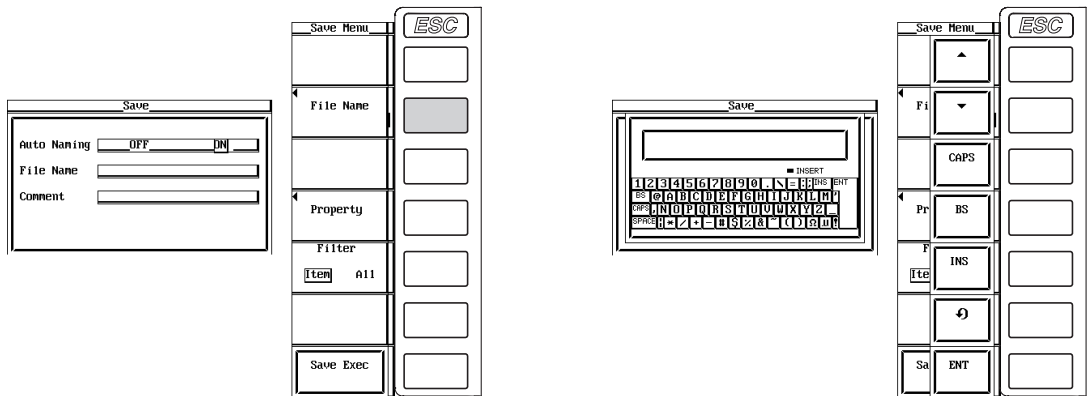

**Executing the Save Operation**

25. Press the **Save Exec** soft key. The data is saved to the directory indicated by Path=..... At the same time, the Save Exec soft key changes to an Abort soft key.

**Aborting the Save Operation**

26. Press the **Abort** soft key to abort the save operation. At the same time, the Abort soft key changes to a Save Exec soft key.

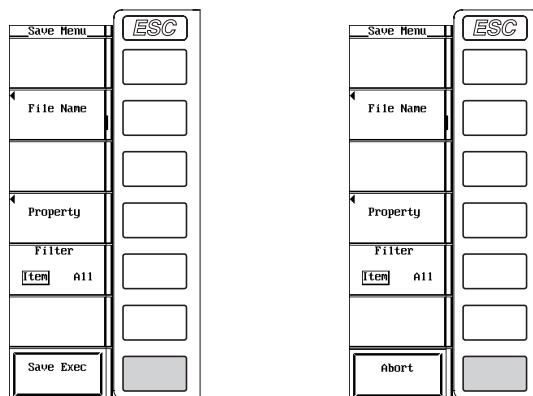

**Specifying the File to Be Displayed on the File List Dialog Box**

Same as the procedure given in “Specifying the File to Be Displayed on the File List Dialog Box” in section 12.9.

**Viewing the Properties**

Same as the procedure given in “Viewing the Properties” in section 12.9.

### Explanation

---

#### **CAUTION**

Do not remove the medium (disk) or turn off the power when the access indicator or  is blinking. Such acts can damage the medium or destroy the data on the medium.

---

Setup Parameters, Waveform Display Data, and Numerical Data can be saved.

#### **Saving Setup Parameters**

Select Setup from the File Item menu to save setup parameters.

- **Setup parameters that are saved**

The setup parameter of each key existing at the time of the save operation can be saved. However, setup parameters such as the date and time, communications, and SCSI ID numbers are not saved.

- **Data size**

The data size of a single set of setup parameters is approximately 20 KB.

- **Extension**

.set extension is automatically added to the file name.

#### **Saving the Displayed Waveform Data**

Select Wave from the File Item menu to save waveform display data.

- **Selecting the data type**

Select the data type from the following list of choices. The extension is automatically added.

- Binary

- Saved in binary format.
- The file cannot be loaded to the WT1600.

- ASCII

- Saved in ASCII format.
- The file can be used on your PC for analysis.
- The file cannot be loaded to the WT1600.

- Float

- Saved in 32-bit floating format.
- The file cannot be loaded to the WT1600.

- **Extension and data size**

- During normal measurement

Data Type	Extension	Data Size (Bytes)
Binary	.WVF .HDR	Approx. (4 K + 4 × 1002 × T <sub>w</sub> ), T <sub>w</sub> : Number of displayed waveforms Approx. 7 K
ASCII	.CSV	Approx. 15 K (condition: when there is one displayed waveform)
Float	.FLD	Approx. (4 K + 4 × 1002)

- During harmonic measurement  
Same as for normal measurement.

- **Selecting the waveform**

- When the data type is set to Binary or ASCII, the waveform that is displayed on the screen is saved.
- When the data type is Float, the waveform of the input signal selected from the following is saved.
  - Only the input signals of the installed elements are applicable for the selection.
  - For models with the motor evaluation function (option), the input signals of Speed and Torque are also selectable items.
- The setup parameters including vertical axis, horizontal axis, and trigger of the waveform to be saved are also saved.

**Saving the Numerical Data**

Select Numeric from the File Item menu to save numerical data.

- **Selecting the data type**

Select the data type from the following list of choices. The extension is automatically added.

- ASCII
  - Saved in ASCII format.
  - The file can be used on your PC for analysis.
  - The file cannot be loaded to the WT1600.
- Float
  - Saved in 32-bit floating format.
  - The file cannot be loaded to the WT1600.

- **Extension and data size**

- During normal measurement

Data Type	Extension	Data Size (Bytes)
ASCII	.CSV	Approx. 2 K (condition: number of elements 1, all measurement functions)
Float	.WTD	When integration is not performed Approx. (4 K + 4 × D <sub>n</sub> ) When integration is performed Approx. (4 K + (4 × D <sub>n</sub> + 16 × T <sub>i</sub> )) D <sub>n</sub> : Number of numerical data to be saved (Number of measurement functions × (number of elements + number of wiring units)) T <sub>i</sub> : Number of integration time to be saved

## 12.6 Saving Setup Parameters, Waveform Display Data, and Numerical Data

- During harmonic measurement

Data Type	Extension	Data Size (Bytes)
ASCII	.CSV	Approx. 4.2 K (condition: number of elements 1, measurement functions U and Others, maximum order* 100)
Float	.WTD	Approx. (4 K + 4 K × D <sub>n</sub> ) D <sub>n</sub> : Number of numerical data to be saved <ul style="list-style-type: none"> <li>• When U, I, or P are to be saved: Number of elements × maximum order* × 2</li> <li>• When S to X<sub>p</sub> are saved: Number of elements × maximum order*</li> <li>• When Others are stored: Number of elements × 11 + 21</li> </ul>

\* The maximum harmonic order to be analyzed as specified in section 7.5.

### • Selecting the numerical data

Select which numerical data items are to be saved.

- During normal measurement
  - Only installed elements and wiring units are applicable for the selection.
  - The measurement functions can be selected from the items that are indicated in “Measurement Function Types during Normal Measurement” and “Measurement Function Types for Motor Evaluation Function (Option)” in section 1.2; “Delta Computation,” “User-Defined Functions,” and “Corrected Power” in section 1.5; and “Measurement Functions of Integration” in section 1.6.

- During harmonic measurement

- Only installed elements are applicable for the selection.
- The measurement functions can be selected from U (including Uhdf), I (including Ihdf), P (including Phdf), S, Q, λ, φ, φU, φI, Z, Rs, Xs, Rp, Xp, and Others\*.

\* If Others is selected, the measurement functions Uthd, Ithd, Pthd, Uthf, Ithf, Utif, Itif, hvf, hcf, fU, and fI of the selected elements, phase difference φ, Σ functions, user-defined functions, and so on are saved.

### Selecting the Medium and Directory

Media on which saving and reading is possible are displayed on the File List dialog box.

#### Display example of media

[FD0]: Floppy disk

[SC4]: SCSI device whose ID number is 4 (built-in hard disk, fixed to ID4)

[SC5]: SCSI device whose ID number is 5 (see section 12.3)

[SC5\_01]: Partition 1 of a SCSI device whose ID number is 5

[ND0]: Network drive (see section 13.3)

### File Name and Comment

- A file name must be assigned. Comments are optional.
- You cannot save to a file name that already exists in the same directory (overwriting not allowed).

### Number of Characters and Types That Can Be Used

Item	Number of Characters	Characters That Can Be Used
File name	1 to 8 characters	0-9, A-Z, %, _, ( ) (parenthesis), - (minus sign)
Comment	0 to 25 characters	Characters that are displayed on the keyboard and spaces

### Auto Naming Function

When Auto Naming is turned ON, files with a three digit number from 000 to 999 are automatically created when saving the data. You can specify a common name (up to five characters, specified through Filename) that is placed before the number.

### Specifying the File to Be Displayed on the File List Dialog Box

Same as the explanation given in “Specifying the File to Be Displayed on the File List Dialog Box” in section 12.9.

### Properties

Same as the explanation given in “Properties” in section 12.9.

### Note

---

- For the meanings of the measurement function symbols that are displayed, see section 1.2, “Measurement Functions and Measurement Periods,” 1.5, “Computation,” 1.6, “Integration,” appendix 1, “Symbols and Determination of Measurement Functions,” and appendix 2, “Determination of Delta Computation.”
  - For details on the wiring units expressed as  $\Sigma A$ ,  $\Sigma B$ ,  $\Sigma C$ , see section 5.1, “Selecting the Wiring System.”
  - The maximum order for which the harmonic data is saved is the maximum harmonic order to be analyzed that is specified in section 7.5.
  - If you change the extension of the file such as on a PC, the file can no longer be loaded.
  - The following data is saved in the places where numerical data does not exist when saving the numerical data.
    - For ASCII files: Characters NAN, +INF, -INF, or ERROR.
    - For Float files: 0x7FC00000, 0x7F800000, 0xFF800000, or 0xFFFFFFFFE.
  - Up to 36 characters can be displayed in Path.
  - The file names are not case-sensitive. Comments are case-sensitive. In addition, the following five file names cannot be used due to limitations of MS-DOS. AUX, CON, PRN, NUL, and CLOCK
  - When using the GP-IB or serial interface commands to enter a file name, the following symbols that do not exist on the keyboard of this instrument can be used.  
{ }
  - Setup parameters that have been saved on products with firmware version having incompatible data cannot be loaded.
-

# 12.7 Saving Screen Image Data

## Keys

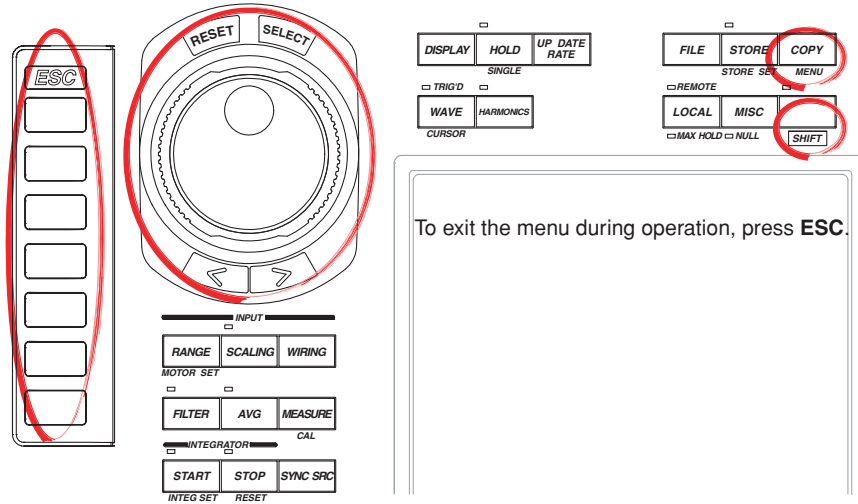

To exit the menu during operation, press **ESC**.

## Procedure

1. Press **SHIFT+COPY (MENU)** to display the Copy menu.
2. Press the **Copy to** soft key to display the Copy to menu.
3. Press the **File** soft key.

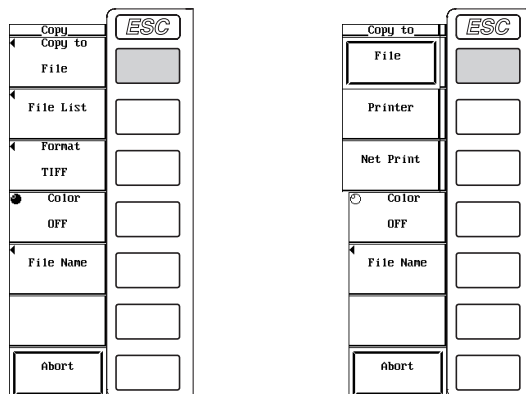

### Selecting the Save Destination Medium and Directory

4. Press the **File List** soft key to display the File List dialog box.
5. Same as the procedures given in "Selecting the Save Destination Medium" and "Selecting the Save Destination Directory" in section 12.6.
6. Press **ESC** to close the File List dialog box.

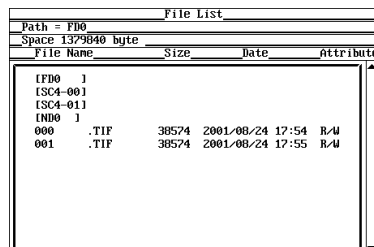



**Selecting the Data Format**

7. Press the **Format** soft key to display the Format menu.
8. Press one of the soft keys from **TIFF to Post Script** to select the data format.  
If you select TIFF or BMP, proceed to step 9.  
If you selected Post Script, proceed to step 11.

**Selecting the Color**

(This procedure is applicable if you selected TIFF or BMP in step 8.)

9. Turn the **jog shuttle** to select Color to OFF.  
If the data format is BMP and you selected Color or Reverse, proceed to step 10.  
If you selected the TIFF data format or color OFF, proceed to step 11.

**Turning ON/OFF the Data Compression**

(This procedure is applicable if you selected BMP in step 8 and Color or Reverse in Step 9.)

10. Press the **Compression** soft key to select ON or OFF.

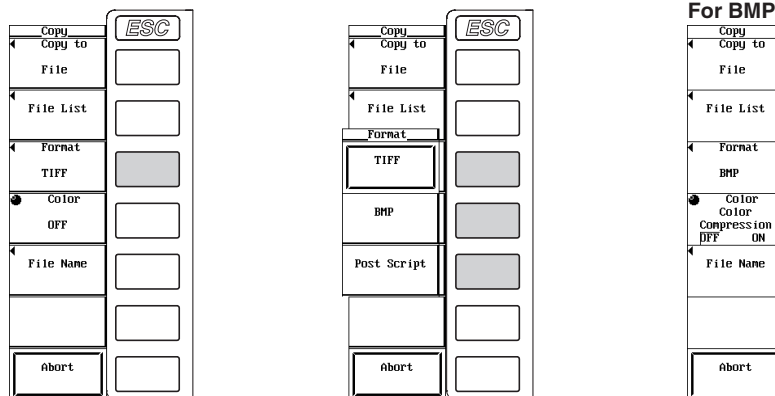

**Setting the File Name and Comment**

11. Same as the procedure given in "Setting the File Name and Comment" in section 12.6.

**Executing the Save Operation**

12. Switch to the screen you wish to save.
13. Press **COPY**. The screen image data is saved to the directory indicated by Path=.....

**Aborting the Save Operation**

14. Press the **Abort** soft key in the Copy menu.

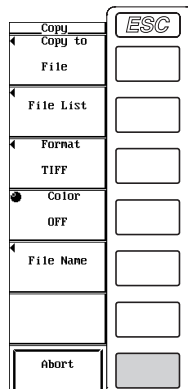

### Explanation

You can save the screen image data.

#### Selecting the Medium and Directory

Same as the explanation given in “Selecting the Medium and Directory” in section 12.6.

#### Data Format Selection, Extension, and Data Size

Select the data format from the following list of choices. The extension is automatically added.

Data Format	Extension	Data Size (Bytes)
TIFF	.TIF	Approx. 350 K (Color)
BMP	.BMP	Approx. 50 K (Color, Compress is ON)
PostScript	.PS	Approx. 80 K

\* Reference value. For PostScript, there are no Color, Reverse, and data compression selection items. For TIFF, there is no data compression selection item.

#### Selecting the Color

Select the color when the data format is TIFF or BMP from the following list of choices.

- Color  
Saves the screen image data in color (256 colors).
- Reverse  
Saves the screen image data with a white background, black text, and colored waveforms.
- OFF  
Saves the screen image data in black and white.

#### Turning ON/OFF Data Compression

When the data format is BMP and the color selection is Color or Reverse, select from the following list of choices.

- OFF  
Outputs the data without compression.
- ON  
Saves the BMP format image using RLE data compression.

#### File Name and Comment

Same as the explanation given in “File Name and Comment” in section 12.6. However, only the first 20 characters of the comment can be displayed on the screen.

#### Auto Naming Function

Same as the explanation in “Auto Naming Function” in section 12.6.

# 12.8 Loading Setup Parameters

## Keys

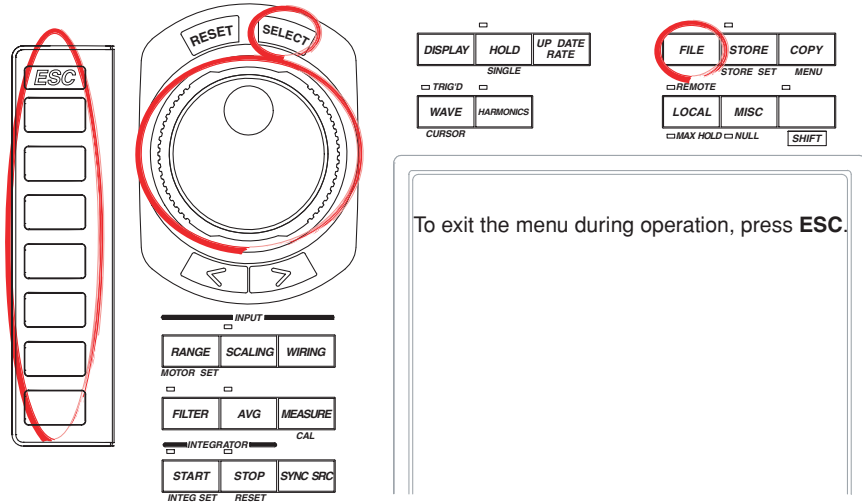

## Procedure

1. Press **FILE** to display the File menu.
2. Press the **File Item** soft key to display the File Item menu.
3. Press the **Setup** soft key to select the setup parameters.

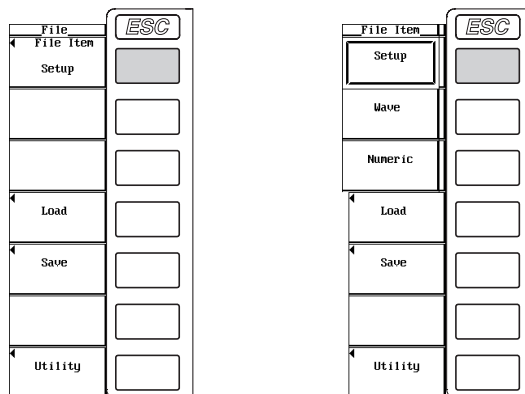

## 12.8 Loading Setup Parameters

- Press the **Load** soft key. The Load Menu menu and the File List dialog box appear.

### Selecting the Load Source Medium

- Turn the **jog shuttle** to select the load source medium (indicated by [ ]).
- Press **SELECT** to confirm the new medium.

### Selecting the Load Source Directory

- (Perform this operation when directories are present on the medium.)
- Turn the **jog shuttle** to select the load source directory (indicated by < >).
  - Press **SELECT** to confirm the new directory.

The selected medium/directory is displayed in "Path=....." located at the upper left corner of the File List dialog box.

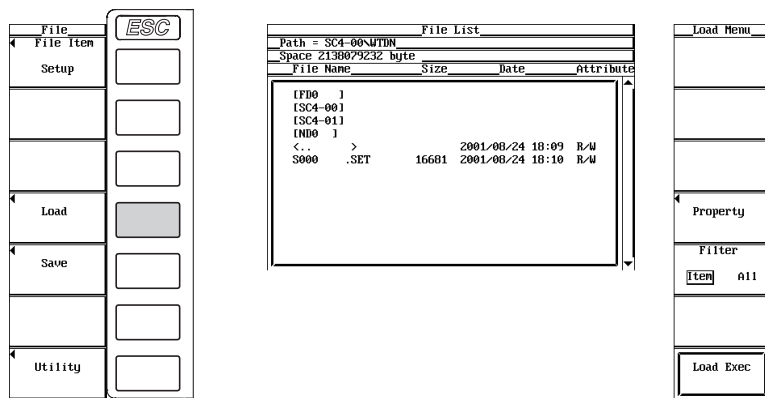

### Selecting the File to Be Loaded

- Turn the **jog shuttle** to select the file.

### Executing the Load Operation

- Press the **Load Exec** soft key. The selected file is read from the directory indicated in Path=..... At the same time, the Load Exec soft key changes to an Abort soft key.

### Aborting the Load Operation

- Press the **Abort** soft key to abort the load operation. At the same time, the Abort soft key changes to a Load Exec soft key.

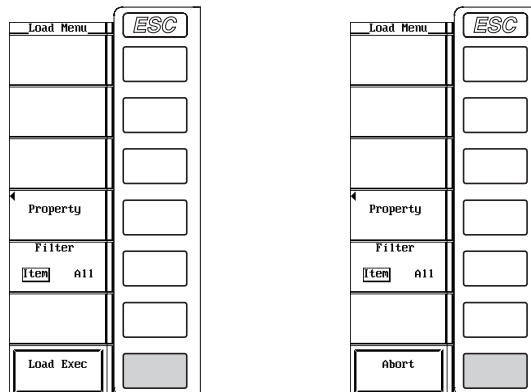

**Specifying the File to Be Displayed on the File List Dialog Box**

Same as the procedure given in “Specifying the File to Be Displayed on the File List Dialog Box” in section 12.9.

**Viewing the Properties**

Same as the procedure given in “Viewing the Properties” in section 12.9.

**Explanation****CAUTION**

Do not remove the medium (disk) or turn OFF the power when the access indicator or  is blinking. Such acts can damage the medium or destroy the data on the medium.

The setup parameters saved using the WT1600 can be loaded.

**Selecting the Medium and Directory**

Same as the explanation given in “Selecting the Medium and Directory” in section 12.6.

**Specifying the File to Be Displayed on the File List Dialog Box**

Same as the explanation given in “Specifying the File to Be Displayed on the File List Dialog Box” in section 12.9.

**Properties**

Same as the explanation given in “Properties” in section 12.9.

**Note**

- If you change the extension of the file such as on a PC, the file can no longer be loaded.
- Up to 36 characters can be displayed in Path.
- The file names are not case-sensitive. Comments are case-sensitive.
- If the setup parameters that are saved to a file is loaded, the key settings are changed to the loaded information and cannot be undone. It is recommended that you first save the current setup parameters and then load the setup parameters from a file.
- Setup parameters such as the date and time, communications, and SCSI ID numbers are not saved. Therefore, loading setup parameters from a file will not change the date and time, communication, and SCSI ID settings.
- Setup parameters that have been saved on products with firmware version having incompatible data cannot be loaded.
- Settings can not be loaded between different models, or models with different element configurations, firmware (ROM), options, or other characteristics.

## 12.9 Specifying the File to Be Displayed, Viewing File Properties, and Changing the File Attribute

### Keys

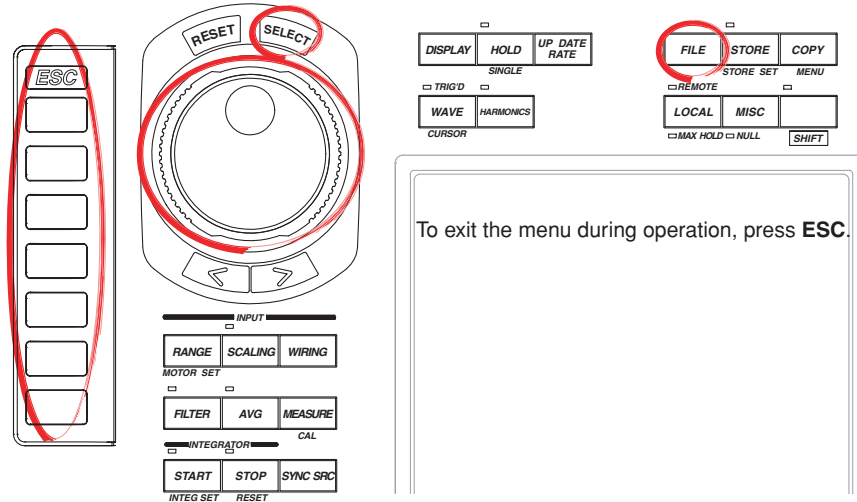

### Procedure

1. Press **FILE** to display the File menu.
2. Press the **Utility** soft key. The Utility menu and the File List dialog box appear.
3. Press the **Function** soft key to display the Function menu.
4. Press the **Delete** soft key to display the Delete menu.

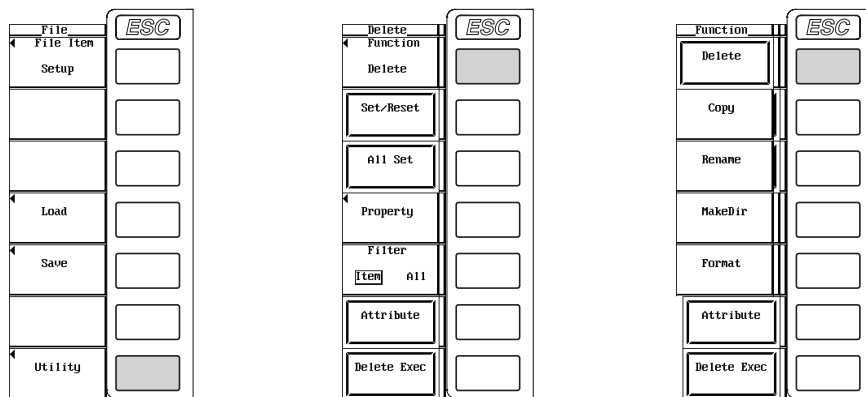

### Selecting the Medium and Directory

5. Same as the procedures given in "Selecting the Save Destination Medium" and "Selecting the Save Destination Directory" in section 12.6.

**Specifying the File to Be Displayed on the File List Dialog Box**

6. Press the **Filter** soft key to select Item or All.
  - If you select Item, the list of files corresponding to the file type (Setup, Wave, or Numeric) that is specified for File Item in the File menu, in the directory selected in step 5, is displayed.
  - If you select All, the list of all the files in the directory selected in step 5 is displayed.

**Viewing the Properties**

7. On the File List dialog box, turn the **jog shuttle** to select the file.
8. Press the **Property** soft key to display the file property window.
9. Press **ESC** to close the file property window.

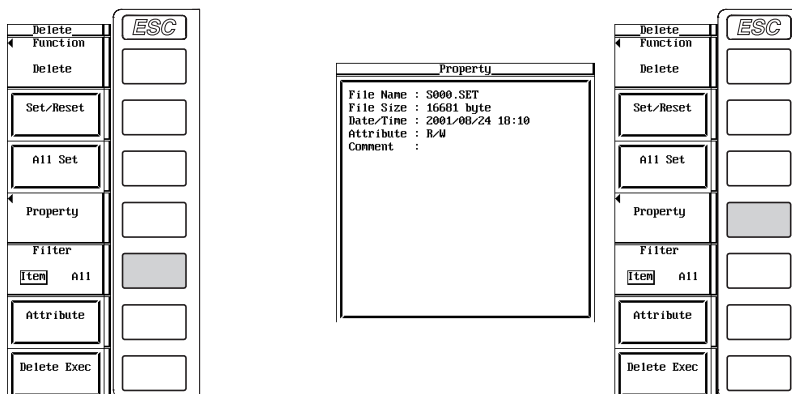

**Changing the File Attribute**

10. Turn the **jog shuttle** to select a file.
11. Press the **Attribute** soft key to change the attribute of the selected file to R or R/W.

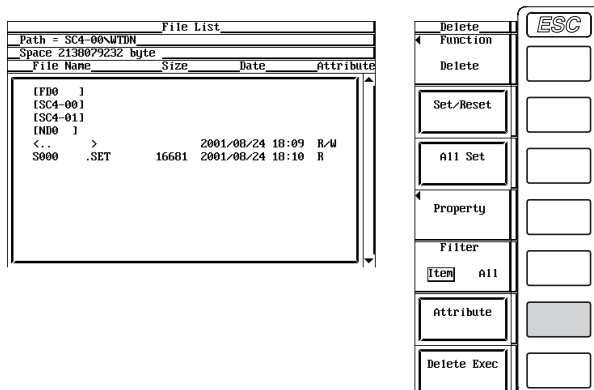

### Explanation

---

#### **CAUTION**

Do not remove the medium (disk) or turn OFF the power when the access indicator or  is blinking. Such acts can damage the medium or destroy the data on the medium.

---

#### **Selecting the Medium and Directory**

Same as the explanation given in “Selecting the Medium and Directory” in section 12.6.

#### **Specifying the File to Be Displayed on the File List Dialog Box**

You can specify the file to be displayed on the File List dialog box.

- Item  
The list of files corresponding to the file type (Setup, Wave, or Numeric) that is specified for File Item in the File menu, in the selected directory, is displayed.
- All  
The list of all the files in the selected directory is displayed.

#### **Property**

Displays the filename.extension, the file size, the date the file was saved, the attribute, and the comment of the selected file.

#### **Selecting the File Attribute**

Select the file attribute of each file from the following list of choices.

- R/W  
Read and write.
- R  
Read only. No writing or deleting.

#### **Note**

---

You cannot change a directory attribute.

---



# 12.10 Deleting Files

## Keys

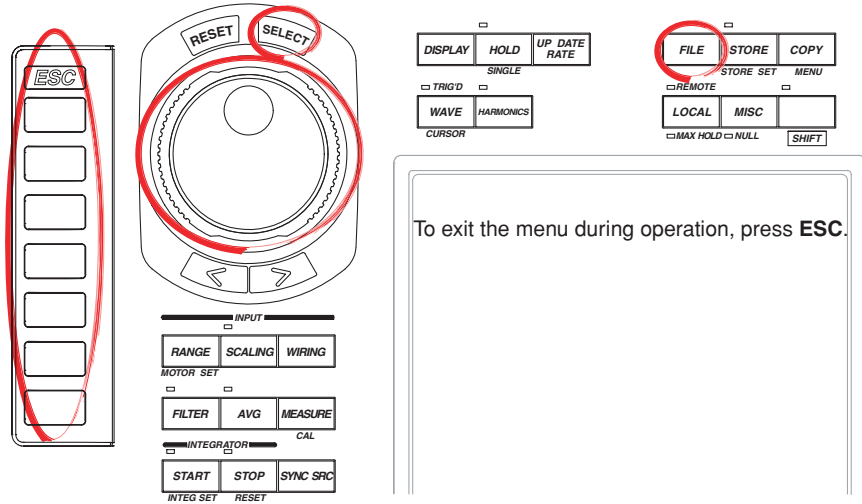

## Procedure

1. Press **FILE** to display the File menu.
2. Press the **Utility** soft key. The Utility menu and the File List dialog box appear.
3. Press the **Function** soft key to display the Function menu.
4. Press the **Delete** soft key to display the Delete menu.

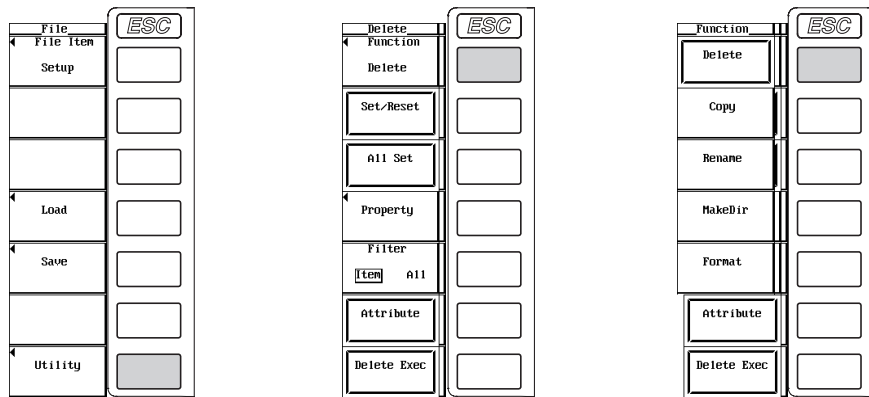

### Selecting the Medium and Directory

5. Same as the procedures given in “Selecting the Save Destination Medium” and “Selecting the Save Destination Directory” in section 12.6.

### Specifying the File to Be Displayed on the File List Dialog Box

6. Same as the procedure given in “Specifying the File to Be Displayed on the File List Dialog Box” in section 12.9.

### Viewing the Properties

7. Same as the procedure given in “Viewing the Properties” in section 12.9.

### Changing the File Attribute

8. Same as the procedure given in “Changing the File Attribute” in section 12.9.

**Selecting the File to Be Deleted One at a Time**

9. Turn the **jog shuttle** to select a file.
10. Press the **Set/Reset** soft key. If an asterisk is displayed to the left of the file name in the File List dialog box, the file will be deleted. If the asterisk to the left of the file name disappears, the file will not be deleted.

Proceed to step 12.

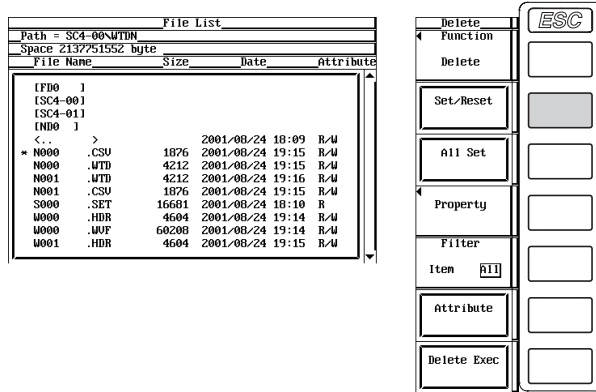

**Selecting the Files to be Deleted at Once**

9. Turn the **jog shuttle** to select a file, directory, or medium.
10. Press the **All Set** soft key. Asterisks appear to the left of the directory containing the selected file and all the files in the directory, the selected directory and all the files in the directory, or all the directories and files in the selected medium. The corresponding items will be deleted. At the same time, the All Set key changes to an All Reset soft key.
11. Press the **All Reset** soft key. Asterisks to the left of the directory containing the selected file and all the files in the directory, the selected directory and all the files in the directory, or all the directories and files in the selected medium disappear. The corresponding items will not be deleted. At the same time, the All Reset soft key changes to an All Set soft key.

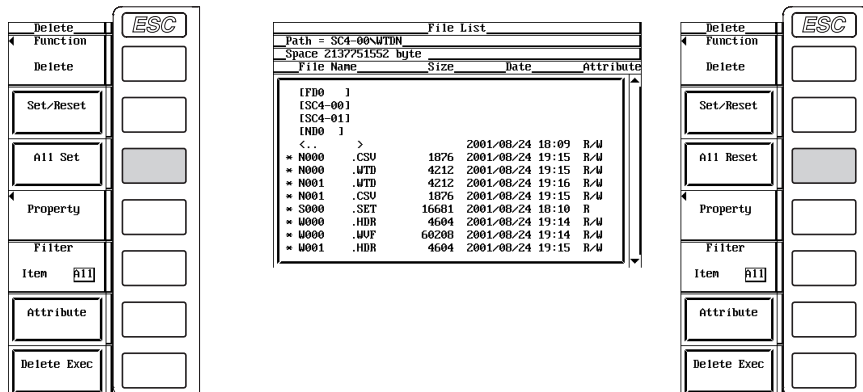

**Executing the Delete Operation**

12. Press the **Delete Exec** soft key. All files with asterisks are deleted.

**Explanation****CAUTION**

Do not remove the medium (disk) or turn OFF the power when the access indicator or  is blinking. Such acts can damage the medium or destroy the data on the medium.

**Selecting the Medium and Directory**

Same as the explanation given in “Selecting the Medium and Directory” in section 12.6.

**Specifying the File to Be Displayed on the File List Dialog Box**

Same as the explanation given in “Specifying the File to Be Displayed on the File List Dialog Box” in section 12.9.

**Properties**

Same as the explanation given in “Properties” in section 12.9.

**Selecting the File Attribute**

Same as the explanation given in “Selecting the File Attribute” in section 12.9.

**Selecting the Files to Be Deleted**

- By placing asterisks to the left of the file names, those files can be deleted.
- There are two methods in selecting the files to be deleted.
  - Selecting the files one at a time
    - Press the Set/Reset soft key to place asterisks to the left of the files one at a time.
  - Selecting the files at once
    - Press the All Set soft key to place asterisks to the left of the selected file names at once. There are three methods in selecting the files at once.
      - If you select a file and press the All Set soft key, asterisks are placed by the directory containing the selected file and all the files in the directory.
      - If you select a directory and press the All Set soft key, asterisks are placed by the selected directory and all the files in the directory.
      - If you select a medium and press the All Set soft key, asterisks are placed by all the directories and files in the selected medium.

**Note**

- Data that is deleted cannot be recovered. Make sure you erase the correct files.
- You can delete directories if there are no files in them.
- When File Item is Wave, Data Type is Binary, and Filter is Item, deleting a file with a .wvf extension that has an asterisk causes the file with the same name with the .hdr extension to also be deleted. When Filter is All, only the files that have the asterisks are deleted.
- If the file attribute (see section 12.9) is “R,” you cannot delete the file.
- If an error occurs while deleting multiple files, the files after the error occurrence are not deleted.

## 12.11 Copying Files

### Keys

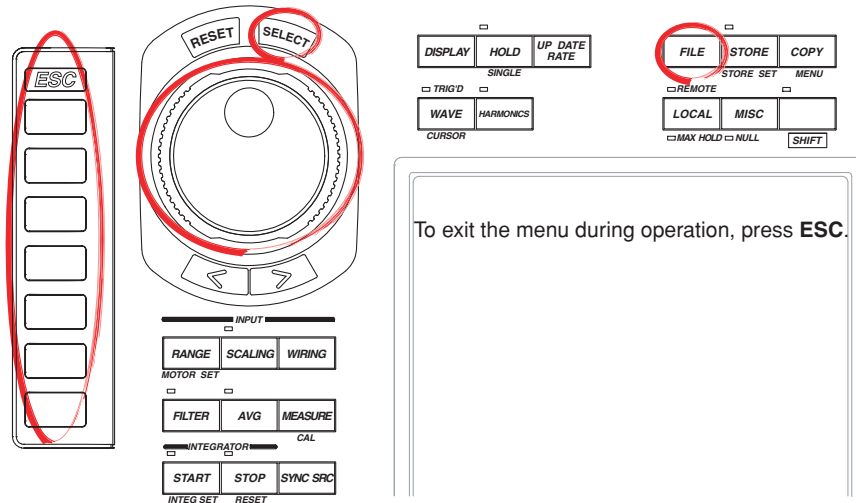

### Procedure

1. Press **FILE** to display the File menu.
2. Press the **Utility** soft key. The Utility menu and the File List dialog box appear.
3. Press the **Function** soft key to display the Function menu.
4. Press the **Copy** soft key to display the Copy menu.

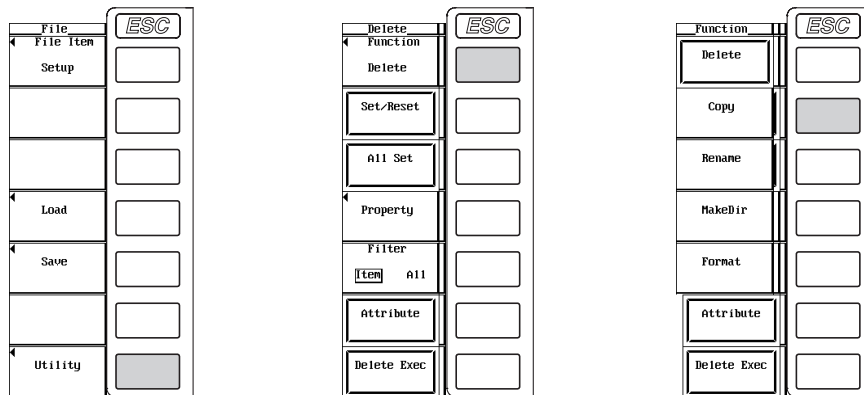

#### Selecting the copy destination medium and directory

5. Same as the procedures given in “Selecting the Save Destination Medium” and “Selecting the Save Destination Directory” in section 12.6.

#### Specifying the File to Be Displayed on the File List Dialog Box

6. Same as the procedure given in “Specifying the File to Be Displayed on the File List Dialog Box” in section 12.9.

#### Viewing the Properties

7. Same as the procedure given in “Viewing the Properties” in section 12.9.

#### Changing the File Attribute

8. Same as the procedure given in “Changing the File Attribute” in section 12.9.

### Selecting the Copy Source Files One at a Time

9. Turn the **jog shuttle** to select a file.
10. Press the **Set/Reset** soft key. If an asterisk is displayed to the left of the file name in the File List dialog box, the file will be copied. If the asterisk to the left of the file name disappears, the file will not be copied.

Proceed to step 12.

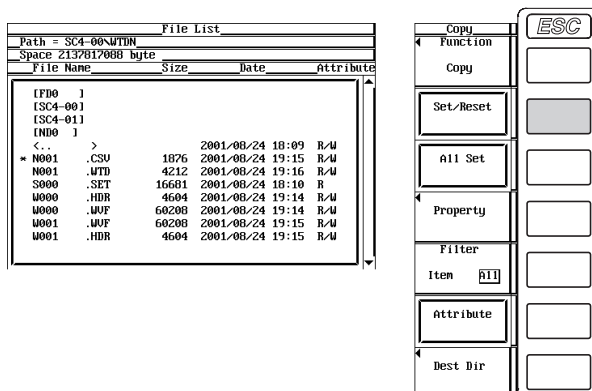

### Selecting the Copy Source Files at Once

9. Turn the **jog shuttle** to select a file, directory, or medium.
10. Press the **All Set** soft key. Asterisks appear to the left of the directory containing the selected file and all the files in the directory, the selected directory and all the files in the directory, or all the directories and files in the selected medium. The corresponding items will be copied. At the same time, the All Set soft key changes to an All Reset soft key.
11. Press the **All Reset** soft key. Asterisks to the left of the directory containing the selected file and all the files in the directory, the selected directory and all the files in the directory, or all the directories and files in the selected medium disappear. The corresponding items will not be copied. At the same time, the All Reset soft key changes to an All Set soft key.

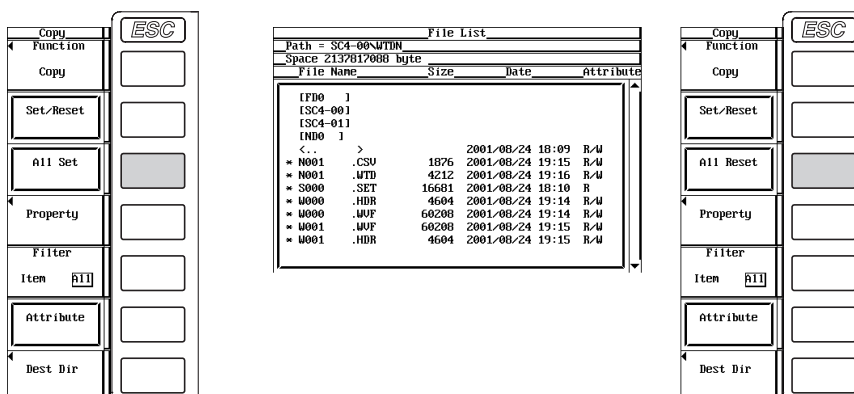

**Selecting the Copy Destination**

12. Press the **Dest Dir** soft key. The copy execution menu and the copy destination File List dialog box appears.

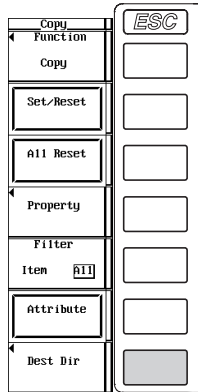

**Selecting the copy destination medium or directory**

13. Same as the procedures given in “Selecting the Save Destination Medium” and “Selecting the Save Destination Directory” in section 12.6.

**Executing the Copy Operation**

14. Press the **Copy Exec** soft key. All the copy source files with asterisks are copied.

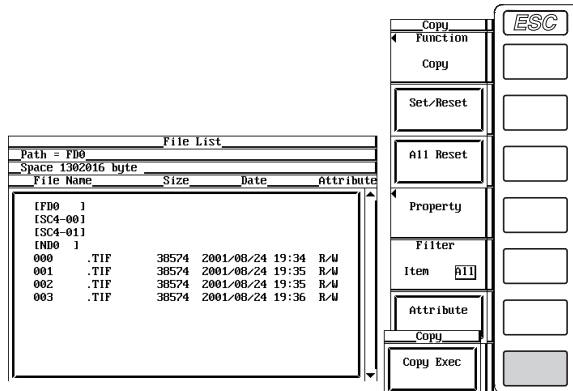

**Explanation****CAUTION**

Do not remove the medium (disk) or turn OFF the power when the access indicator or  is blinking. Such acts can damage the medium or destroy the data on the medium.

**Selecting the Copy Source/Destination Medium and Directory**

Same as the explanation given in “Selecting the Medium and Directory” in section 12.6.

**Specifying the File to Be Displayed on the File List Dialog Box**

Same as the explanation given in “Specifying the File to Be Displayed on the File List Dialog Box” in section 12.9.

**Properties**

Same as the explanation given in “Properties” in section 12.9.

**Selecting the File Attribute**

Same as the explanation given in “Selecting the File Attribute” in section 12.9.

**Selecting the Copy Source Files**

- By placing asterisks to the left of the file names, those files can be copied.
- There are two methods in selecting the files to be copied.
  - Selecting the files one at a time  
Press the Set/Reset soft key to place asterisks to the left of the files one at a time.
  - Selecting the files at once  
Press the All Set soft key to place asterisks to the left of the selected file names at once. There are three methods in selecting the files at once.
    - If you select a file and press the All Set soft key, asterisks are placed by the directory containing the selected file and all the files in the directory.
    - If you select a directory and press the All Set soft key, asterisks are placed by the selected directory and all the files in the directory.
    - If you select a medium and press the All Set soft key, asterisks are placed by all the directories and files in the selected medium.

**Note**

- You cannot copy files if files with the same file name exist at the copy destination.
- You cannot copy the same files to another directory after copying the files. Select the files to be copied again and copy them.
- When File Item is Wave, Data Type is Binary, and Filter is Item, copying a file with a .wvf extension that has an asterisk causes the file with the same name with the .hdr extension to also be copied. When Filter is All, only the files that have the asterisks are copied.
- If an error occurs while copying multiple files, the files after the error occurrence are not copied.

# 12.12 Renaming Directories and Files and Creating Directories

## Keys

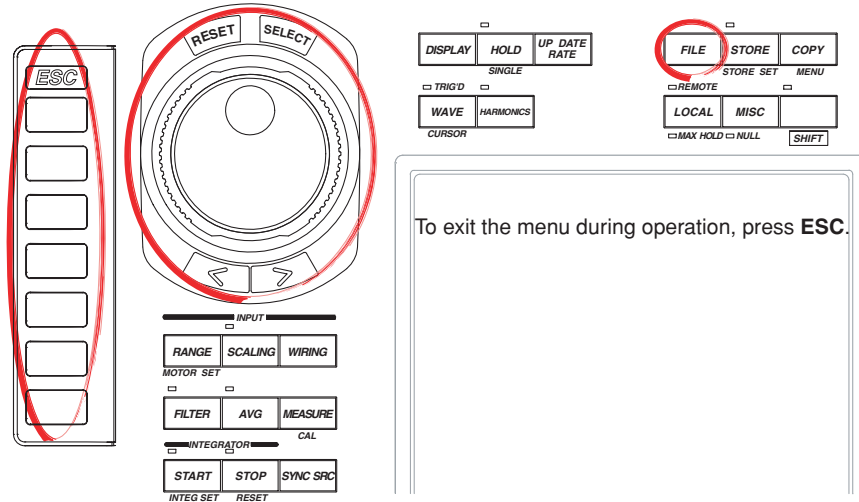

## Procedure

1. Press **FILE** to display the File menu.
2. Press the **Utility** soft key. The Utility menu and the File List dialog box appear.
3. Press the **Function** soft key to display the Function menu.

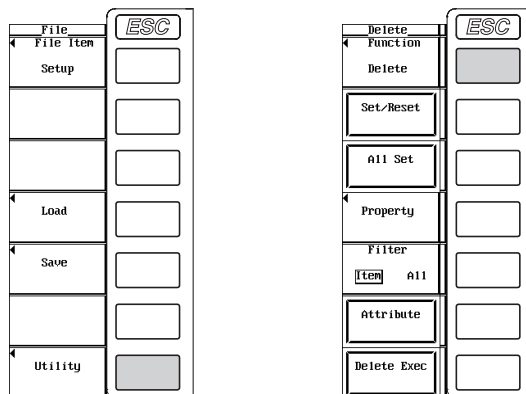



### Renaming a Directory or File

- Press the **Rename** soft key to display the Rename menu.

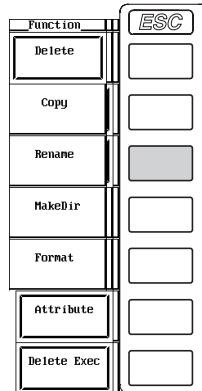

#### Selecting the Medium and Directory

- Same as the procedures given in “Selecting the Save Destination Medium” and “Selecting the Save Destination Directory” in section 12.6.

#### Specifying the File to Be Displayed on the File List Dialog Box

- Same as the procedure given in “Specifying the File to Be Displayed on the File List Dialog Box” in section 12.9.

#### Viewing the Properties

- Same as the procedure given in “Viewing the Properties” in section 12.9.

#### Changing the File Attribute

- Same as the procedure given in “Changing the File Attribute” in section 12.9.

### Renaming a Directory or File

- Turn the **jog shuttle** to select a directory or file.
- Press the **File Name** soft key to display the keyboard. The name of the selected directory or file is displayed in the entry box of the keyboard.
- Use the **keyboard** to enter the directory or file name.  
For keyboard operations, see section 3.12, “Entering Values and Strings.”

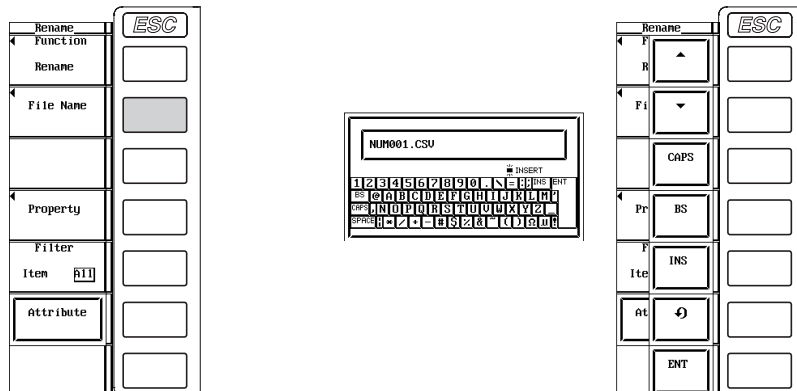

**Creating a Directory**

4. Press the **MakeDir** soft key to display the MakeDir menu.

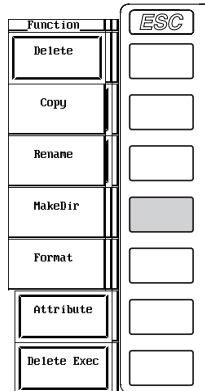

**Selecting the Medium and Directory**

5. Same as the procedures given in “Selecting the Save Destination Medium” and “Selecting the Save Destination Directory” in section 12.6.

**Specifying the File to Be Displayed on the File List Dialog Box**

6. Same as the procedure given in “Specifying the File to Be Displayed on the File List Dialog Box” in section 12.9.

**Viewing the Properties**

7. Same as the procedure given in “Viewing the Properties” in section 12.9.

**Changing the File Attribute**

8. Same as the procedure given in “Changing the File Attribute” in section 12.9.

**Creating a Directory**

9. Turn the **jog shuttle** to select a medium or directory.
10. Press the **Dir Name** soft key to display the keyboard.
11. Use the **keyboard** to enter the directory name.

For keyboard operations, see section 3.12, “Entering Values and Strings.”

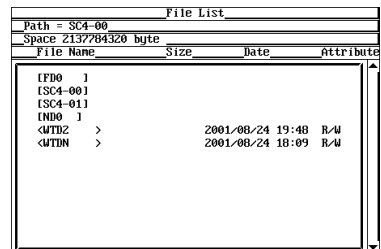
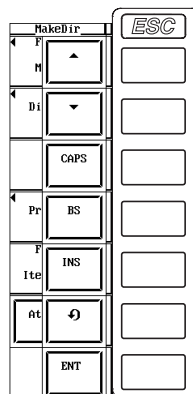
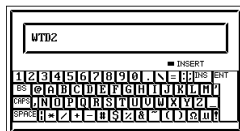
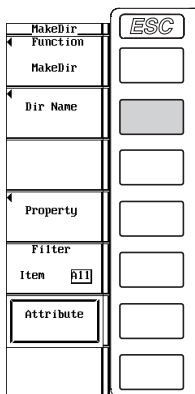

**Explanation**

---

**CAUTION**

---

Do not remove the medium (disk) or turn OFF the power when the access indicator or  is blinking. Such acts can damage the medium or destroy the data on the medium.

---

**Selecting the Copy Source/Destination Medium and Directory**

Same as the explanation given in “Selecting the Medium and Directory” in section 12.6.

**Specifying the File to Be Displayed on the File List Dialog Box**

Same as the explanation given in “Specifying the File to Be Displayed on the File List Dialog Box” in section 12.9.

**Properties**

Same as the explanation given in “Properties” in section 12.9.

**Selecting the File Attribute**

Same as the explanation given in “Selecting the File Attribute” in section 12.9.

**Renaming a Directory or File**

The method in setting the name when renaming a directory or file is the same as the explanation given in “File Name and Comment” in section 12.6.

**Creating a Directory**

You can create a new directory in the medium. The method in setting the name when creating a directory is the same as the explanation given in “File Name and Comment” in section 12.6.

**Note**

---

- You cannot change a directory attribute.
  - If a file with the same name already exists in the same directory, the file cannot be renamed.
  - If a directory with the same name already exists in the same directory, the directory cannot be created.
  - When File Item is Wave, Data Type is Binary, and Filter is Item, renaming the name of the selected file with a .WVF extension causes the file with the same name with the .HDR extension to be changed. When Filter is All, the name of only the selected files is changed.
-

## 13.1 Connecting the WT1600 to a PC

### Network Connection

To connect to a network, connect a UTP (Unshielded Twisted-Pair) cable or an STP (Shielded Twisted-Pair) cable that is connected to a hub, for example, to the 10BASE-T port on the rear panel of the WT1600.

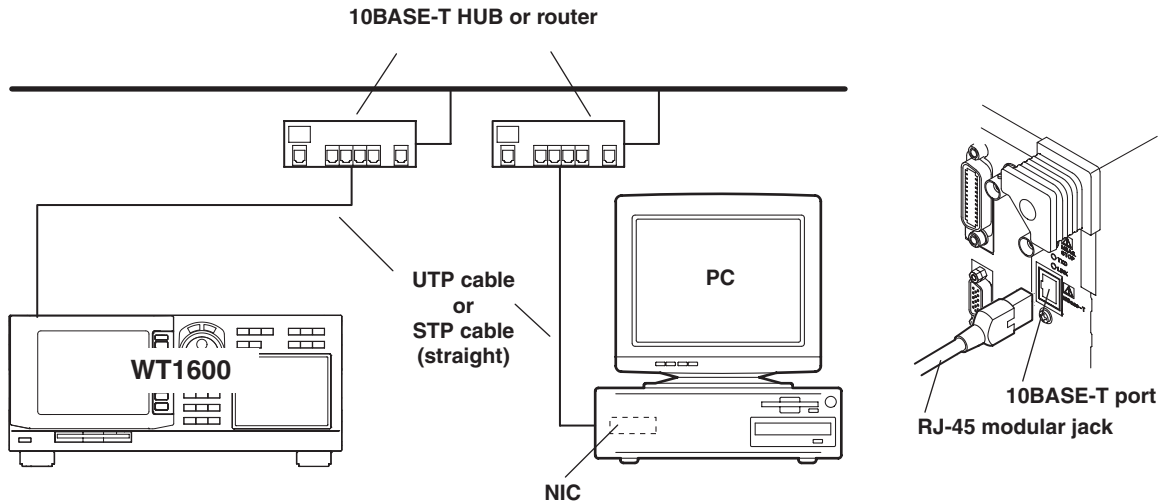

### One-to-One Connection

Even when connecting the WT1600 and a PC in a one-to-one configuration, connect them via a hub as shown below.

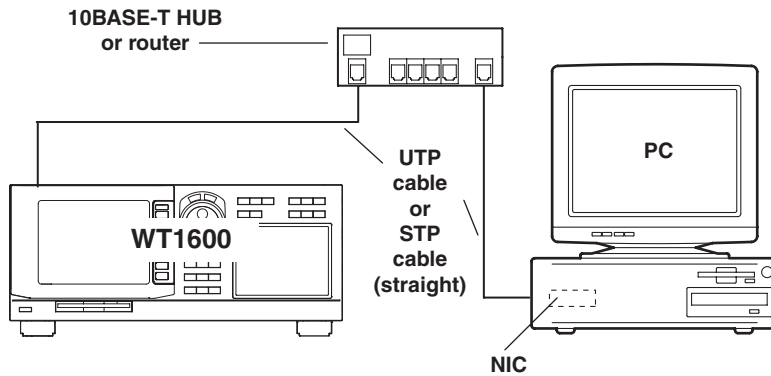

### Note

- When connecting the WT1600 and a PC in a one-to-one configuration, use a 10BASE-T/100BASE-TX auto switching NIC or a 10BASE-T NIC on the PC side.
- Avoid connecting the WT1600 and a PC directly without going through a hub. Operations are not guaranteed for communications using direct connection.

## 13.2 Setting the Ethernet Interface (TCP/IP)

### Keys

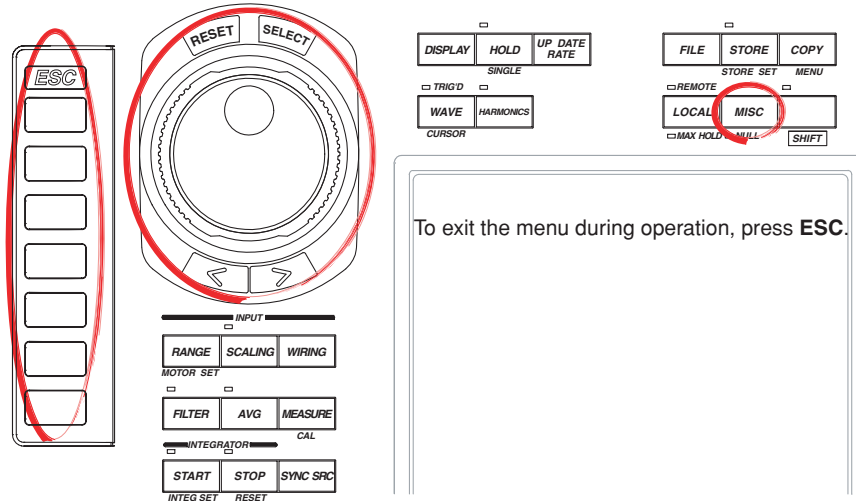

### Procedure

1. Press **MISC** to display the Misc menu.
2. Press the **Next 1/2** soft key to display the Next 2/2 menu.
3. Press the **Network** soft key to display the Network menu.

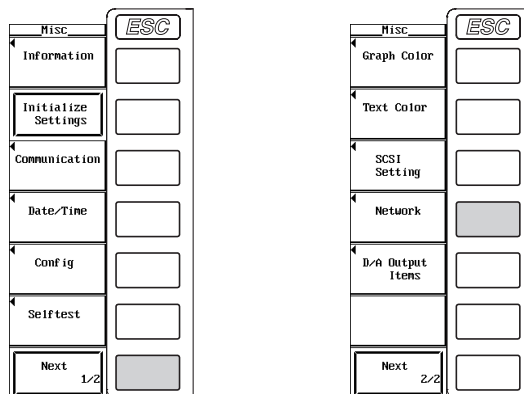

4. Press the **TCP/IP Setup** soft key to display the TCP/IP Setup dialog box.

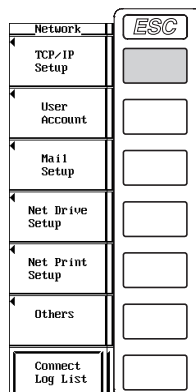

### When Using Only DHCP

5. Turn the **jog shuttle** to select DHCP.
6. Press **SELECT** to select ON.
7. Turn the **jog shuttle** to select DNS.
8. Press **SELECT** to display the DNS selection box.
9. Turn the **jog shuttle** to select OFF.

The screenshot shows a terminal window titled "TCP/IP Setup". At the top, "DHCP" is set to "ON" and "DNS" is set to "OFF". Below these are fields for "IP Address", "Net Mask", and "Gate Way", each with four input boxes containing zeros. The "DNS" field has a dropdown menu showing "OFF".

### When Using Only DNS

5. Turn the **jog shuttle** to select DHCP.
6. Press **SELECT** to select OFF.

#### Entering the IP Address

7. Turn the **jog shuttle** to select IP Address.
8. Press **SELECT** to display the IP address entry box.
9. Turn the **jog shuttle** to enter the IP address of the WT1600.  
For the procedures on how to enter values using the jog shuttle, see section 3.12, "Entering Values and Strings."
10. Press **SELECT** or **ESC** to close the box.
11. Enter all four octets of the IP address.

#### Entering the Subnet Mask

Enter the subnet mask according to the system or network to which the WT1600 belongs. If the subnet mask is not required, proceed to "Entering the Default Gateway."

12. Turn the **jog shuttle** to select Net Mask.
13. Enter all four octets of the subnet mask of the network to which the WT1600 belongs in the same fashion as the IP address.

#### Entering the Default Gateway

Enter the default gateway according to the system or network to which the WT1600 belongs. If the default gateway is not required, proceed to "Turning ON the DNS."

14. Turn the **jog shuttle** to select Gate Way.
15. Enter all four octets of the default gateway of the network to which the WT1600 belongs in the same fashion as the IP address.

The screenshot shows the "TCP/IP Setup" menu. The "DHCP" option is now set to "ON". The "IP Address" field is highlighted with a cursor, and the "Net Mask" field is also highlighted. The "Gate Way" and "DNS" fields remain unchanged.

## 13.2 Setting the Ethernet Interface (TCP/IP)

---

### Turning ON the DNS

16. Turn the **jog shuttle** to select DNS.
17. Press **SELECT** to display the DNS selection box.
18. Turn the **jog shuttle** to select ON.
19. Press **SELECT** to confirm the DNS ON setting.

### Entering the Domain Name

Enter the domain name of the system or network to which the WT1600 belongs.

20. Turn the **jog shuttle** to select Domain Name.
21. Press **SELECT** to display the keyboard.
22. Use the **keyboard** to enter the domain name of the network to which the WT1600 belongs.

For keyboard operations, see section 3.12, "Entering Values and Strings."

### Entering the Address of the Primary DNS Server

23. Turn the **jog shuttle** to select DNS Server1.
24. Enter all four octets of the primary DNS server address in the same fashion as the IP address.

### Entering the Address of the Secondary DNS Server

Enter the information if the system or network to which the WT1600 belongs uses a secondary DNS server. If a secondary server is not used, proceed to "Entering the Primary Domain Suffix."

25. Turn the **jog shuttle** to select DNS Server2.
26. Enter all four octets of the secondary DNS server address in the same fashion as the IP address.

### Entering the Primary Domain Suffix

Enter the information if a domain suffix is required.

27. Turn the **jog shuttle** to select Domain Suffix1.
28. Enter the primary domain suffix in the same fashion as the IP address.

### Entering the Secondary Domain Suffix

Enter the information if a secondary domain suffix is present.

29. Turn the **jog shuttle** to select Domain Suffix2.
30. Enter the secondary domain suffix in the same fashion as the IP address.

The screenshot shows a window titled "TCP/IP Setup". It contains several fields and options:

- DHCP**: A dropdown menu currently set to "OFF".
- IP Address**: A text field containing "192.168.111.24".
- Net Mask**: A text field containing "255.255.255.0".
- Gate Way**: A text field containing "0.0.0.0".
- DNS**: A dropdown menu currently set to "ON".
- Domain Name**: An empty text field.
- DNS Server1**: A text field containing "0.0.0.0".
- DNS Server2**: A text field containing "0.0.0.0".
- Domain Suffix1**: An empty text field.
- Domain Suffix2**: An empty text field.

### When Using Both DHCP and DNS

5. Turn the **jog shuttle** to select DHCP.
  6. Press **SELECT** to select ON.
  7. Turn the **jog shuttle** to select DNS.
  8. Press **SELECT** to display the DNS selection box.
  9. Turn the **jog shuttle** to select ON or Auto.
- If you selected ON, you must enter information according to “Entering the Domain Name” through “Entering the Secondary Domain Suffix” on the previous page.
- If you selected Auto, the entry information from “Entering the Domain Name” to “Entering the Secondary Domain Suffix” is automatically set by the DHCP server. Therefore, you do not have to enter the information.

The screenshot shows the 'TCP/IP Setup' menu. At the top, 'DHCP' is set to 'ON'. Below it, 'IP Address' is '0.0.0.0', 'Net Mask' is '255.255.255.0', and 'Gate Way' is '0.0.0.0'. The 'DNS' section has a 'Select' dropdown menu open, showing 'OFF', 'ON', and 'Auto' options. The 'Domain' and 'Domain Suffix' fields are empty.

#### Explanation

To use the Ethernet communication functions of the WT1600, DHCP, IP address, IP address, subnet mask, default gateway, and DNS must be specified. Consult your system or network administrator in setting these parameters.

#### DHCP (Dynamic Host Configuration Protocol)

- The IP address, subnet mask, default gateway, and DNS can be automatically specified by using DHCP.
- To use DHCP, the network must have a DHCP server.
- Consult your network administrator to see if DHCP can be used.
- If you use DHCP, a different IP address may be assigned every time the WT1600 is powered up. You must be careful when using the FTP server function of the WT1600.

#### IP Address (Internet Protocol Address)

- Enter the IP address assigned to the WT1600. The default setting is “0.0.0.0.”
- The IP address is used to uniquely identify a device on the Internet when using TCP/IP. The address is a 32-bit value expressed using four octets (each 0 to 255), each separated by a period as in [192.168.111.24].
- A unique IP address must be obtained from the network administrator.
- If DHCP can be used, the address is automatically assigned.



### Subnet Mask

- Enter the mask value used when determining the subnet network address from the IP address. The default setting is “255.255.255.0.”
- Consult your network administrator for the appropriate value. You may not need to set the value.
- If DHCP can be used, the subnet mask is automatically assigned.

### Default Gateway

- Enter the IP address of the default gateway that is used when communicating with other devices on a different segment (network unit). The default setting is “0.0.0.0.”
- Consult your network administrator for the appropriate value. You may not need to set the value.
- If DHCP can be used, the default gateway is automatically assigned.

### DNS (Domain Name System)

DNS is a system used to associate names used on the Internet called host names and domain names to IP addresses. Given AAA.BBBBB.com, AAA is the host name and BBBBB.com is the domain name. Instead of using the IP address, which is a sequence of numbers, host name and domain name can be used to access the network.

- Enter the domain name, the DNS server address, and the domain suffix. If DHCP can be used, these values are automatically assigned.
- When accessing a network drive or a network printer from the WT1600, a name can be used to access the destination rather than an IP address.

- **Entering the domain name**

- Enter the network domain name that the WT1600 belongs to.
- Enter up to 30 characters.
- The characters that can be used are 0-9, A-Z, %, \_, ( ) (parenthesis), - (minus sign).

- **Entering the DNS server address**

- Enter the IP address of the DNS server. The default setting is “0.0.0.0.”
- You can specify up to two DNS server addresses, primary and secondary. When the primary DNS server is down, the secondary DNS server is automatically looked up for the mapping of the host name/domain name and IP address.

- **Entering the Domain Suffix**

- When the IP address corresponding to the server name with the domain name specified in the previous section is not found, the system may be set up to search using a different domain name. Enter this alternate domain name as the domain suffix.
- You can specify up to two domain suffixes, primary and secondary.

### Note

---

- If you changed settings related to the Ethernet network, the WT1600 must be power cycled.
- If the WT1600 is turned ON with the DHCP function enabled without an Ethernet cable connected, communications and file functions may not operate properly. In this case, turn DHCP OFF and power cycle the WT1600.

**Configuring the TCP/IP Settings of the PC**

Communication parameters such as the IP address must be specified also on the PC side. Communication parameters are specified for each Ethernet NIC that is installed in the PC. Here, the settings of the NIC required for connecting your PC and the WT1600 are explained.

If the IP address and other parameters are to be assigned dynamically using the DHCP server, the following settings are not necessary.

Select **Obtain an IP address automatically** under the **IP Address** tab of the **TCP/IP Properties** dialog box.

For example, if you are connecting a PC and the WT1600 to an independent Ethernet network, you can specify parameters as indicated in the next table. For details on the parameters, consult your system or network administrator.

Parameter	Value	Notes
IP address	(Example) 192.168.21.128	IP address for the PC
Subnet mask	(Example) 255.255.255.0	Set the same value as the subnet mask that was specified for the WT1600.
Gateway	None	
DNS	Not used	
WINS	Not used	

The following procedure describes the steps for Windows 95/98. If you are using Windows NT/2000 Pro carry out equivalent steps according to your operating system.

1. Select **Start > Settings > Control Panel**. The Control Panel opens.
2. Double-click the **Network** icon to display the **Network** dialog box.
3. Select **TCP/IP** corresponding to the Ethernet NIC that is connected to your PC and click **Properties**. The **TCP/IP Properties** dialog box appears.

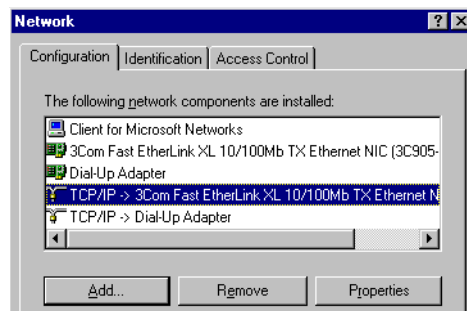

4. Set the parameters such as the IP address according to the table above and click **OK**.

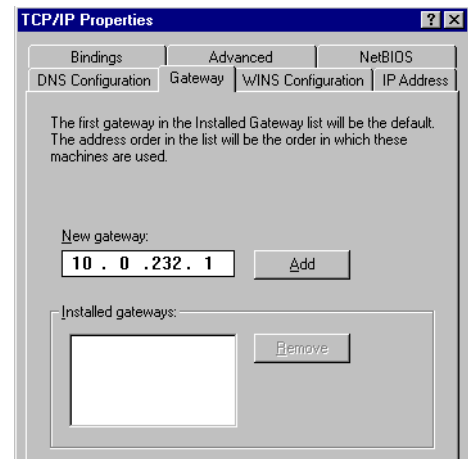
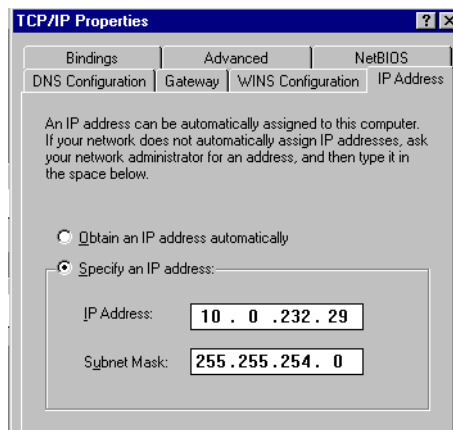

# 13.3 Saving Setup, Waveform Display, Numerical, and Image Data to the FTP Server (FTP Client Function)

## Keys

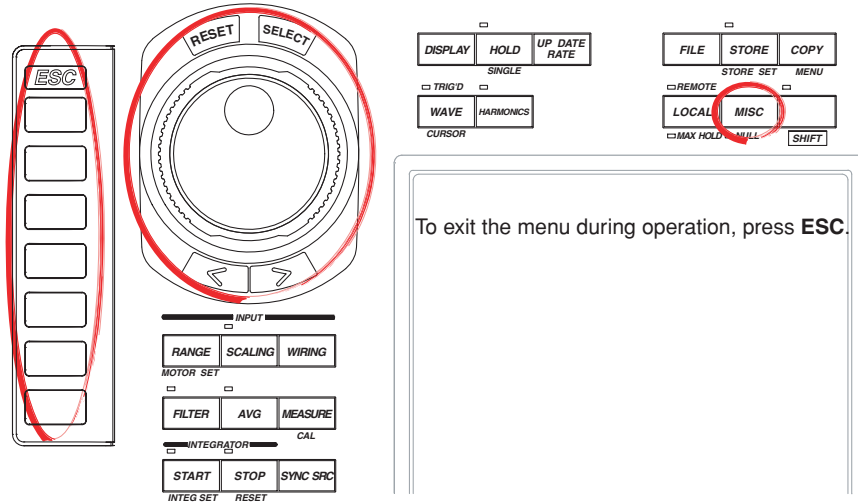

## Procedure

1. Press **MISC** to display the Misc menu.
2. Press the **Next 1/2** soft key to display the Next 2/2 menu.
3. Press the **Network** soft key to display the Network menu.

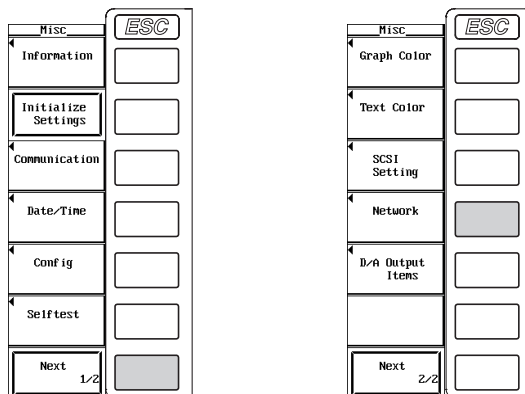

4. Press the **Net Drive Setup** soft key to display the Net Drive Setup dialog box.

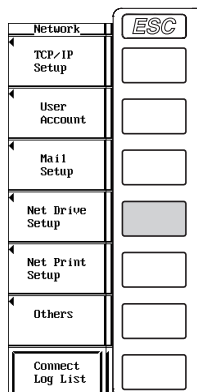

#### Specifying the Save Destination FTP Server

5. Turn the **jog shuttle** to select FTP Server.
6. Press **SELECT** to display the keyboard.
7. Use the **keyboard** to enter the IP address of the FTP server. If you are using DNS, you can specify the server by name.

For keyboard operations, see section 3.12, "Entering Values and Strings."

#### Entering the Login Name and Password for Accessing the Save Destination FTP Server

8. Turn the **jog shuttle** to select Login Name.
9. Press **SELECT** to display the keyboard.
10. Use the **keyboard** to enter the login name.  
For keyboard operations, see section 3.12, "Entering Values and Strings."
11. Turn the **jog shuttle** to select Password.
12. Press **SELECT** to display the keyboard.
13. Use the **keyboard** to enter the password. Password is not required if the login name is anonymous.

For keyboard operations, see section 3.12, "Entering Values and Strings."



#### Setting the Timeout Time

14. Turn the **jog shuttle** to select Time Out.
15. Press **SELECT** to display the timeout time selection box.
16. Turn the **jog shuttle** to set the timeout time.

For the procedures on how to enter values using the jog shuttle, see section 3.12, "Entering Values and Strings."

17. Press **SELECT** or **ESC** to close the box.

#### Connecting to/Disconnecting from the Save Destination FTP Server

18. Turn the **jog shuttle** to select Connect or Disconnect.
19. Press **SELECT**.
  - If you select Connect and press SELECT, connection is established to the save destination FTP server. When the connection is made,  is displayed at the upper left corner of the screen.
  - If you select Disconnect and press SELECT, connection to the save destination FTP server is dropped. The  displayed at the upper left corner of the screen disappears.

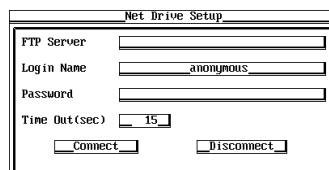

Net Drive Setup

FTP Server	<input type="text"/>
Login Name	<input type="text" value="anonymous"/>
Password	<input type="text"/>
Time Out(sec)	<input type="text" value="15"/>
<input type="button" value="Connect"/> <input type="button" value="Disconnect"/>	

#### Saving the Data

- To save the setup parameters, waveform display data, or numerical data, carry out the save operation according to the procedure given in section 12.6.
- To save the screen image data, carry out the save operation according to the procedure given in section 12.7.
- However, for the procedure "Selecting the Save Destination Medium" on page 12-14, select ND0 for the medium.

### 13.3 Saving Setup, Waveform Display, Numerical, and Image Data to the FTP Server (FTP Client Function)

---

#### Explanation

The FTP client function of the WT1600 can be used to save the setup parameters, waveform display data, numerical data, and screen image data to an FTP server on the network in a similar fashion to saving the various data on a floppy disk or the built-in hard disk.

#### Save Destination FTP Server

- Specify the FTP server by entering the IP address.
- If you are using DNS (see section 13.2), you can specify the server by name.
- The FTP server program must be running on the PC or workstation that is to become the save destination FTP server. In addition, the following points need attention regarding the server program settings.
  - Set the list output (string returned by the dir command) to UNIX format.
  - Set the home directory and its subdirectories to allow writing.
  - The client cannot move above the home directory.
  - The newest file is not necessarily displayed at the top of the file list.
  - Files and directories that are longer than 8 characters cannot be accessed.
  - Depending on the server, "<..>" that indicates a higher directory may not be displayed.
- The time information in the file list will not be displayed correctly for the following cases.
  - On Windows NT when the time stamp is displayed using am and pm.
  - Servers that return characters other than ASCII characters in the list
- The following operations are not possible from the WT1600 on files that have been saved on an FTP server.
  - Enabling/Disabling file protection, copying, and renaming
  - Formatting the FTP server medium

#### Entering the Login Name and Password

Enter the login name and password for accessing the save destination FTP server.

- **Login name**
  - Enter up to 15 characters.
  - The characters that can be used are 0-9, A-Z, %, \_, ( ) (parenthesis), - (minus sign).
- **Password**
  - Enter up to 15 characters.
  - The characters that can be used are 0-9, A-Z, %, \_, ( ) (parenthesis), - (minus sign).

#### Setting the Timeout Time

When an FTP server is accessed from the WT1600 and connection cannot be established after a certain period of time (timeout time), the WT1600 decides that the connection to the FTP server is not possible and closes the connection.

Select the value in the range of 0 to 3600 s. The default value is 15 s.

#### Note

---

- The FTP client function cannot be used under the following cases.
    - When the WT1600 is being accessed by a PC or workstation on the network (FTP server function, see section 13.6).
    - When the WT1600 is performing file operations (see chapter 12).
  - When using the FTP client function, set the TCP/IP parameters according to section 13.2, "Setting the Ethernet Interface (TCP/IP)."
  - To apply new settings that are made while the connection is up, drop the connection using Disconnect and reconnect.
  - If a connection is dropped by the server while you are operating the FTP client, the connection will be automatically reestablished when you display the File List dialog box through file operation.
-

# 13.4 Outputting the Screen Image to a Network Printer

## Keys

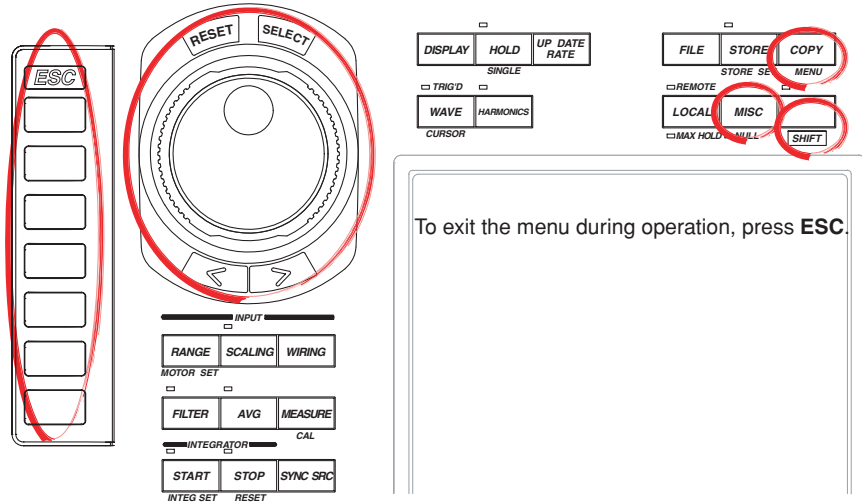

## Procedure

1. Press **MISC** to display the Misc menu.
2. Press the **Next 1/2** soft key to display the Next 2/2 menu.
3. Press the **Network** soft key to display the Network menu.

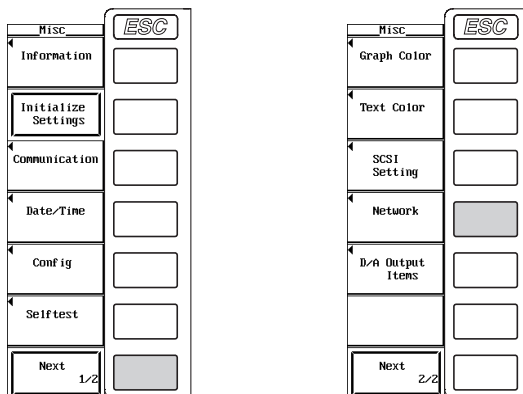

4. Press the **Net Print Setup** soft key to display the Net Print Setup dialog box.

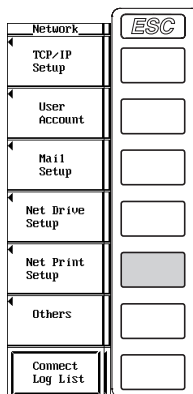

## 13.4 Outputting the Screen Image to a Network Printer

### Specifying the Printer Server

5. Turn the **jog shuttle** to select LPR Server.
6. Press **SELECT** to display the keyboard.
7. Use the **keyboard** to enter the IP address of the printer server. If you are using DNS, you can specify the server by name.

For keyboard operations, see section 3.12, "Entering Values and Strings."

### Entering the Printer Name

8. Turn the **jog shuttle** to select LPR Name.
9. Press **SELECT** to display the keyboard.
10. Use the **keyboard** to enter the printer name.

For keyboard operations, see section 3.12, "Entering Values and Strings."

Net Print Setup	
LPR Server	<input type="text"/>
LPR Name	<input type="text" value="PASSTHRU"/>

### Setting the Output Destination to a Network Printer

1. Press **SHIFT+COPY (MENU)** to display the Copy menu.
2. Press the **Copy to** soft key to display the Copy to menu.
3. Press the **Net Print** soft key.

### Selecting the Output Command

4. Press the **Format** soft key to display the Format menu.
5. Press one of the soft keys from **ESC-P** to **Post Script** to select the output format.

If you selected BJ, proceed to step 6.

If you selected ESC-P, ESC-P2, or PCL5, proceed to step 8 on the next page.

If you selected LIPS3 or Post Script, proceed to step 9 on the next page.

Copy	ESC
Copy to	
File	<input type="checkbox"/>
File List	<input type="checkbox"/>
Format	<input type="checkbox"/>
TIFF	<input type="checkbox"/>
Color	<input type="checkbox"/>
OFF	<input type="checkbox"/>
File Name	<input type="checkbox"/>
	<input type="checkbox"/>
Abort	<input type="checkbox"/>

Copy to	ESC
File	<input type="checkbox"/>
Printer	<input type="checkbox"/>
Net Print	<input type="checkbox"/>
Color	<input type="checkbox"/>
OFF	<input type="checkbox"/>
File Name	<input type="checkbox"/>
	<input type="checkbox"/>
Abort	<input type="checkbox"/>

Copy to	ESC
Copy to	
Net Print	<input type="checkbox"/>
Format	<input type="checkbox"/>
ESC-P2	<input type="checkbox"/>
Color	<input type="checkbox"/>
OFF ON	<input type="checkbox"/>
Comment	<input type="checkbox"/>
	<input type="checkbox"/>
Abort	<input type="checkbox"/>

Format	ESC
ESC-P	<input type="checkbox"/>
ESC-P2	<input type="checkbox"/>
BJ	<input type="checkbox"/>
PCL5	<input type="checkbox"/>
LIPS3	<input type="checkbox"/>
Post Script	<input type="checkbox"/>
Abort	<input type="checkbox"/>

**Selecting the Resolution**

(This procedure is applicable if you selected BJ in step 5.)

6. Press the **Resolution** soft key to display the Resolution menu.
7. Select one of **180dpi** to **360dpi** soft keys to select the resolution.

**Turning ON/OFF the Color Output**

(This procedure is applicable if you selected ESC-P, ESC-P2, BJ, or PCL5 in step 5.)

8. Press the **Color** soft key to select ON or OFF.

**Setting Comments**

9. Press the **Comment** soft key. A keyboard appears.
10. Use the **keyboard** to enter the comment.

For keyboard operations, see section 3.12, "Entering Values and Strings."

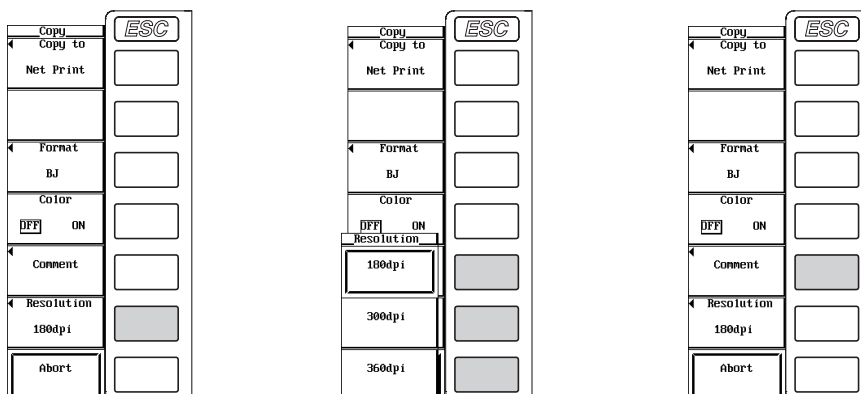

**Executing the Output Operation**

11. Switch to the screen you wish to output.
12. Press **COPY**. The screen image is output.

**Canceling the Output Operation**

13. Press the **Abort** soft key in the Copy menu.

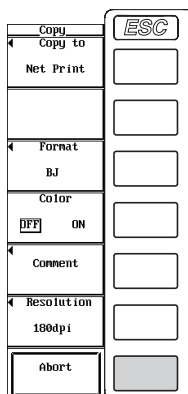



## 13.4 Outputting the Screen Image to a Network Printer

---

### Explanation

The LPR client function of the WT1600 can be used to output screen images to a network printer in the same fashion as outputting the image on a floppy disk or the built-in hard disk.

#### Printer Server

- Specify the printer server by entering the IP address.
- If you are using DNS (see section 13.2), you can specify the server by name.

#### Printer Name

Enter the name of the output destination printer on the network.

#### Selecting the Output Command

Select the output command type from the following list of choices.

- ESC-P
- ESC-P2 (for printers that support ESC/P raster commands)
- BJ
- PCL5
- LIPS3
- Post Script

#### Turning ON/OFF the Color Output

You can select whether to output the image in color when the output command type is ESC-P, ESC-P2, BJ, or PCL5.

- **ON**  
The displayed screen image can be output to a printer in color (256 colors).
- **OFF**  
The displayed screen image can be output to a printer in black and white.

#### Setting Comments

Same as the explanation given in “File Name and Comment” in section 12.6.

#### Note

---

- The LPR client function cannot be used under the following cases.
    - When the WT1600 is being accessed by a PC or workstation on the network (FTP server function, see section 13.6).
    - When the WT1600 is performing file operations (see chapter 12).
  - When using the LPR client function, set the TCP/IP parameters according to section 13.2, “Setting the Ethernet Interface (TCP/IP).”
  - Output is possible to printers that support the TCP/IP protocol.
-

# 13.5 Sending E-mail Messages

## Keys

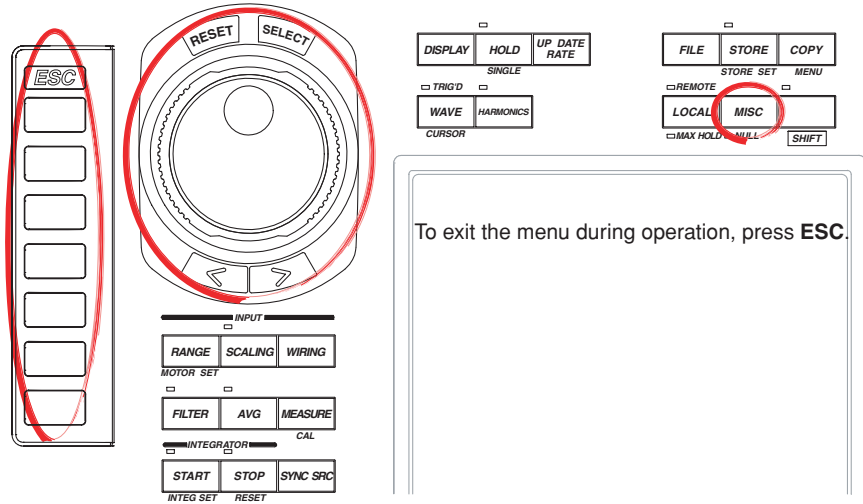

## Procedure

1. Press **MISC** to display the Misc menu.
2. Press the **Next 1/2** soft key to display the Next 2/2 menu.
3. Press the **Network** soft key to display the Network menu.

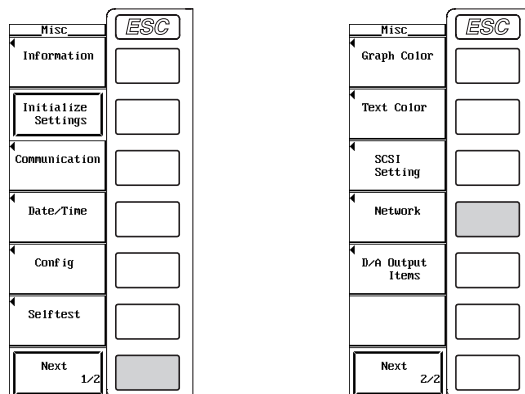

4. Press the **Mail Setup** soft key to display the Mail Setup dialog box.

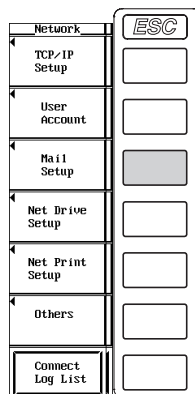

**Specifying the Mail Server**

5. Turn the **jog shuttle** to select Mail Server.
6. Press **SELECT** to display the keyboard.
7. Use the **keyboard** to enter the IP address of the mail server. If you are using DNS, you can specify the server by name.

For keyboard operations, see section 3.12, "Entering Values and Strings."

**Entering the Destination Mail Address**

8. Turn the **jog shuttle** to select Mail Address.
9. Press **SELECT** to display the keyboard.
10. Use the **keyboard** to enter the destination mail address.

For keyboard operations, see section 3.12, "Entering Values and Strings."

**Setting Comments**

(Enter a comment as necessary.)

11. Turn the **jog shuttle** to select Comment.
12. Press **SELECT** to display the keyboard.
13. Use the **keyboard** to enter the comment.

For keyboard operations, see section 3.12, "Entering Values and Strings."

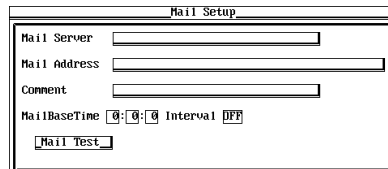

**Setting the Time of Transmission**

14. Turn the **jog shuttle** to select one of the hour, minute, and second boxes of MailBaseTime.
15. Press **SELECT** to display the entry box.
16. Turn the **jog shuttle** to set the hour, minute, or second that you selected in step 14.

For the procedures on how to enter values using the jog shuttle, see section 3.12, "Entering Values and Strings."

17. Press **SELECT** or **ESC** to close the box.
18. Repeat steps 14 to 17 to set hour, minute, and second.

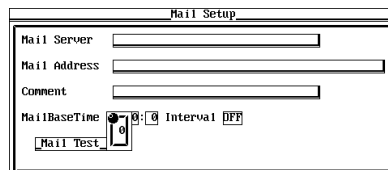

**Selecting the Transmission Interval**

19. Turn the **jog shuttle** to select Interval.
20. Press **SELECT** to display the selection box.
21. Turn the **jog shuttle** to select OFF or 1h to 24h.  
If you select OFF, mails are not transmitted.
22. Press **SELECT** or **ESC** to close the box.

**Performing a Test Transmission**

23. Turn the **jog shuttle** to select Mail Test.
24. Press **SELECT** to send a test mail to the destination.

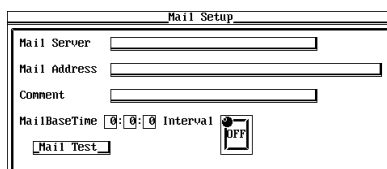
**Explanation**

The condition of the WT1600 can be sent in e-mail messages at a certain interval to a specified mail destination.

**Mail Server**

- Specify the mail server by entering the IP address.
- If you are using DNS (see section 13.2), you can specify the server by name.

**Recipient Mail Address**

Enter the mail address of the device that is to receive the messages sent by the WT1600.

**Setting Comments**

Same as the explanation given in “File Name and Comment” in section 12.6.

**Setting the Time of Transmission**

- Specify the time to start transmitting the e-mail messages.
- Set the time in units of hour : minute : second in the following range.  
0:0:0 to 23:59:59

**Selecting the Transmission Interval**

- Specify the interval for transmitting the e-mail messages.
- You can select from the following list of choices. If you select OFF, mails are not transmitted.  
OFF, 1h, 2h, 3h, 4h, 6h, 8h, 12h, and 24h

## 13.5 Sending E-mail Messages

---

### **Transmitted Information of the WT1600**

The numerical data from numbers 1 to 100 of the menu items (Norm Item No. during normal measurement, Harm Item No. during harmonic measurement) that are displayed when Format (display format) under the Display menu is set to Numeric is transmitted.

### **Note**

---

- When using the SMTP client function, set the TCP/IP parameters according to section 13.2, "Setting the Ethernet Interface (TCP/IP)."
  - The sender (From) address of the e-mail messages sent by the WT1600 is the same as the specified recipient address.
  - When the transmission interval is set to "OFF," mail messages cannot be transmitted.
-

# 13.6 Accessing the WT1600 from a PC or Workstation (FTP Server Function)

## Keys

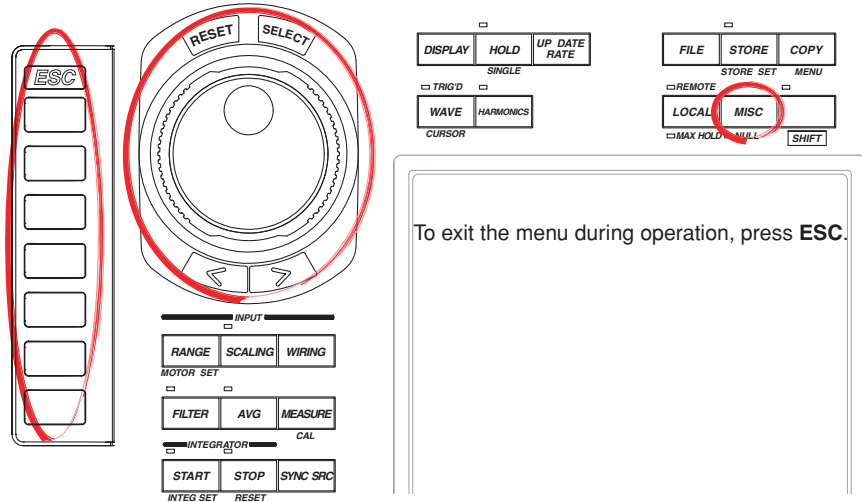

To exit the menu during operation, press **ESC**.

## Procedure

1. Press **MISC** to display the Misc menu.
2. Press the **Next 1/2** soft key to display the Next 2/2 menu.
3. Press the **Network** soft key to display the Network menu.

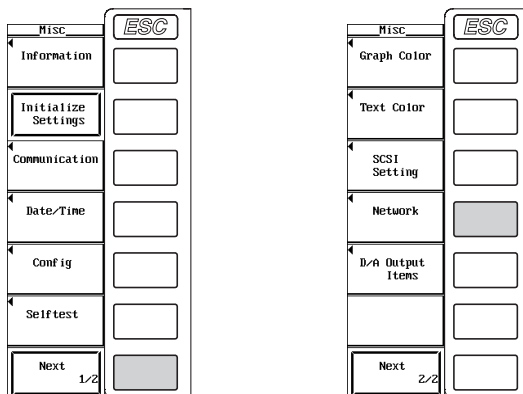

4. Press the **User Account** soft key to display the User Account dialog box.

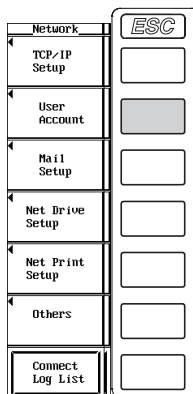

## 13.6 Accessing the WT1600 from a PC or Workstation (FTP Server Function)

---

### Setting the User Name

5. Turn the **jog shuttle** to select User Name.
6. Press **SELECT** to display the keyboard.
7. Use the **keyboard** to enter the user name.
  - For keyboard operations, see section 3.12, "Entering Values and Strings."
  - When not restricting the access, specify anonymous. If you specify anonymous, you do not have to set the password.

### Setting the Password

(If you set user name to anonymous in step 7, you do not have to set the password.)

8. Turn the **jog shuttle** to select Password.
9. Press **SELECT** to display the keyboard.
10. Use the **keyboard** to enter the password.

For keyboard operations, see section 3.12, "Entering Values and Strings."

### Setting the Timeout Time

11. Turn the **jog shuttle** to select Time Out.
12. Press **SELECT** to display the timeout time selection box.
13. Turn the **jog shuttle** to set the timeout time.

For the procedures on how to enter values using the jog shuttle, see section 3.12, "Entering Values and Strings."
14. Press **SELECT** or **ESC** to close the box.



The image shows a dialog box titled "User Account". It contains three input fields: "User Name" with the value "anonymous", "Password" which is empty, and "Time Out (sec)" with the value "600".

### Accessing the WT1600

15. Execute an FTP client software on the PC or workstation.
16. Access the WT1600 using the user name and password specified in the previous section.

**Displaying the Logging List**

17. Press the **Connect Log List** soft key to display the access log of the WT1600.

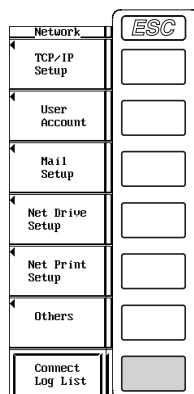
**Explanation**

The floppy disk, built-in hard disk, and SCSI devices connected via SCSI (option) of the WT1600 can be accessed from a PC or workstation (WS) on the network. To access the WT1600, an FTP client software is needed on the PC or workstation.

**Setting the User Name**

- Enter the user name to allow access to the WT1600.
- Enter up to 15 characters.
- The characters that can be used are 0-9, A-Z, %, \_ , ( ) (parenthesis), - (minus sign).
- If you specify anonymous, the WT1600 can be accessed from the outside (PC or WS) without a password.

**Setting the Password**

- Enter the password for the user name to allow access to the WT1600
- Enter up to 15 characters.
- The characters that can be used are 0-9, A-Z, %, \_ , ( ) (parenthesis), - (minus sign).
- If the user name is set to anonymous, the WT1600 can be accessed from the outside (PC or WS) without a password.

**Setting the Timeout Time**

The WT1600 closes the connection to the network if there is no access for a certain period of time (timeout time).

Select the value in the range of 0 to 3600 s. The default value is 60 s.

**Logging List**

The access log of the WT1600 can be displayed. The data and time, user name, and IP address of the 25 recent accesses are displayed.



## 13.6 Accessing the WT1600 from a PC or Workstation (FTP Server Function)

---

### Note

---

- The WT1600 supports only a single client.
  - When the WT1600 is accessed from the PC or workstation (login),  is displayed at the upper left corner of the screen.
  - The FTP server function cannot be used under the following cases.
    - When the WT1600 is accessing a PC or workstation on the network (FTP client function, see section 13.3).
    - When the WT1600 is outputting to a network printer (LPR client function, see section 13.3)
    - When the WT1600 is performing file operations (see chapter 12).
  - In the root directory of the PC or workstation accessing the WT1600, the floppy disk is displayed as [FD0], the built-in hard disk as [SC4\_00][SC4\_01][SC4\_02][SC4\_03][SC4\_04], the network drive as [ND0], other drives connected via SCSI as [SCn] (where n is the SCSI ID), and so on.
  - The logging list is cleared when the power is turned OFF.
  - When using the FTP server function, set the TCP/IP parameters according to section 13.2, "Setting the Ethernet Interface (TCP/IP)."
  - To apply new settings, the WT1600 must be power cycled.
-

# 13.7 Checking the Presence of the Ethernet Interface (Option) and the MAC address

## Keys

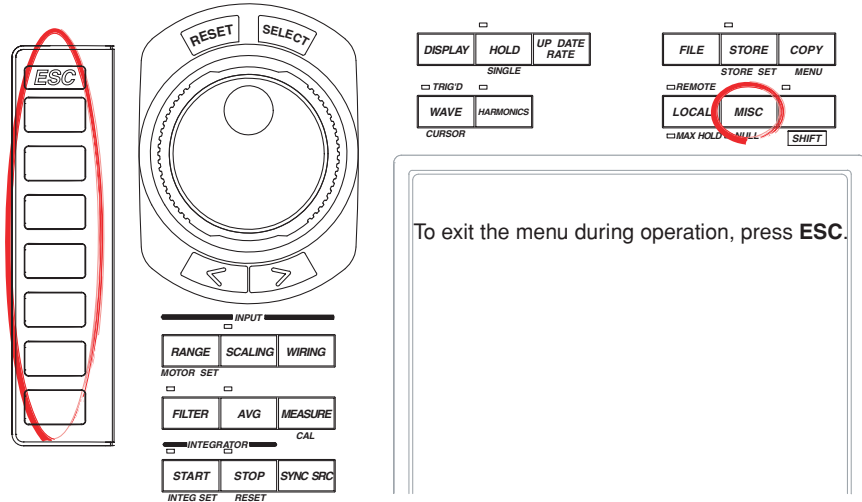

To exit the menu during operation, press **ESC**.

## Procedure

1. Press **MISC** to display the Misc menu.
2. Press the **Information** soft key to display the Information window.  
The presence of the Ethernet interface (option) and the MAC address information are displayed in the Information window.

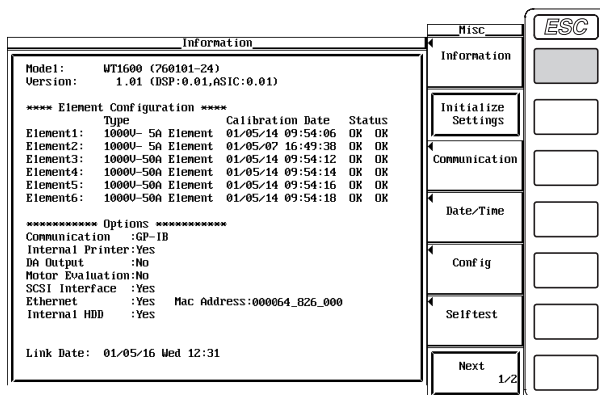

## Explanation

### The Presence of the Ethernet Interface (Option)

The presence of the Ethernet interface is displayed under Ethernet in the Information window.

- If Yes is displayed, the Ethernet interface is installed.
- If No is displayed, the Ethernet interface is not installed.

### MAC Address

MAC address is a unique address that is pre-assigned to the WT1600. The MAC address is displayed under Mac Address in the Information window.

### Note

The MAC address is displayed only on products with the Ethernet interface. If the MAC address appears as xxxxxx\_ xxx\_ xxx even when the Ethernet Interface is installed, then contact your nearest YOKOGAWA dealer.

# 13.8 Setting the FTP Passive Mode and LPR/SNTP Timeout

## Keys

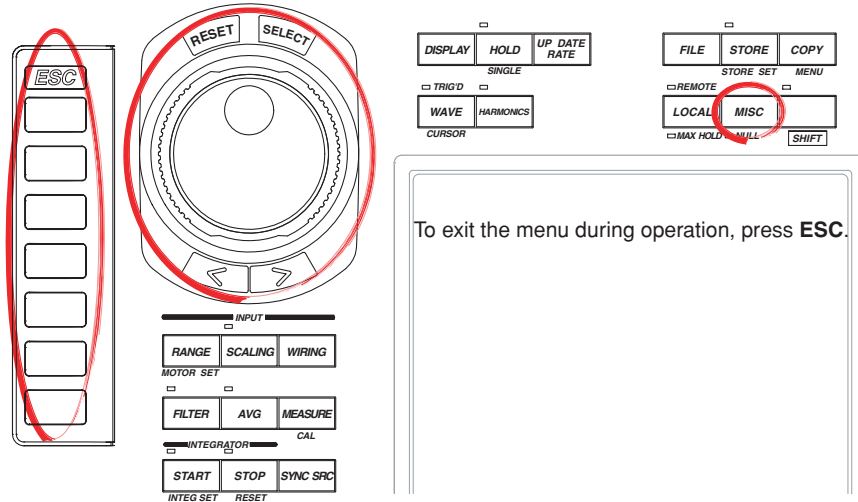

## Procedure

1. Press **MISC** to display the Misc menu.
2. Press the **Next 1/2** soft key to display the Next 2/2 menu.
3. Press the **Network** soft key to display the Network menu.

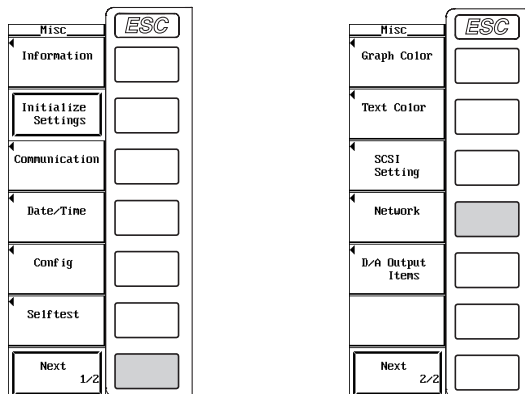

4. Press the **Others** soft key to display the Others dialog box.

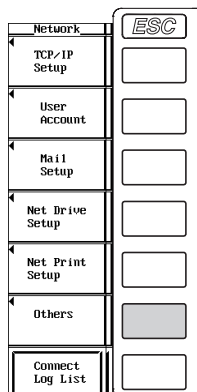

**Turning ON/OFF the FTP Passive Mode**

5. Turn the **jog shuttle** to select FTP Passive.
6. Press **SELECT** to select ON or OFF.

**Setting the LPR Timeout Time**

5. Turn the **jog shuttle** to select LPR Time Out.
6. Press **SELECT** to display the timeout time selection box.
7. Turn the **jog shuttle** to set the timeout time.  
For the procedures on how to enter values using the jog shuttle, see section 3.12, "Entering Values and Strings."
8. Press **SELECT** or **ESC** to close the box.

**Setting the SMTP Timeout Time**

5. Turn the **jog shuttle** to select SMTP Time Out.
6. Press **SELECT** to display the timeout time selection box.
7. Turn the **jog shuttle** to set the timeout time.  
For the procedures on how to enter values using the jog shuttle, see section 3.12, "Entering Values and Strings."
8. Press **SELECT** or **ESC** to close the box.

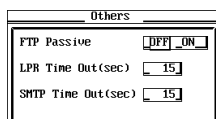
**Explanation**

Enters special settings related to the FTP client, LPR, and SMTP. Normally, these parameters do not need to be specified.

**Turning ON/OFF the FTP Passive Mode**

Turn this function ON when using the WT1600 behind a firewall\* that requires the passive mode. The default setting is OFF.

\* A firewall is furnished on a system that has security features. It prevents intrusion from the outside into the network system.

**Setting the LPR Timeout Time**

The WT1600 closes the connection to the printer if there is no response from the printer for a certain period of time (timeout time) when it accesses the printer. Select the value in the range of 0 to 3600 s. The default value is 15 s.

**Setting the SMTP\* Timeout Time**

When a mail server is accessed from the WT1600 and connection cannot be established after a certain period of time (timeout time), the WT1600 decides that the connection to the mail server is not possible and closes the connection. Select the value in the range of 0 to 3600 s. The default value is 15 s.

\* SMTP (Simple Mail Transfer Protocol) is a protocol that resides above the TCP/IP layer and is used by the e-mail transmission system.

# 14.1 Installing the Paper Roll and Paper Feeding

## Keys

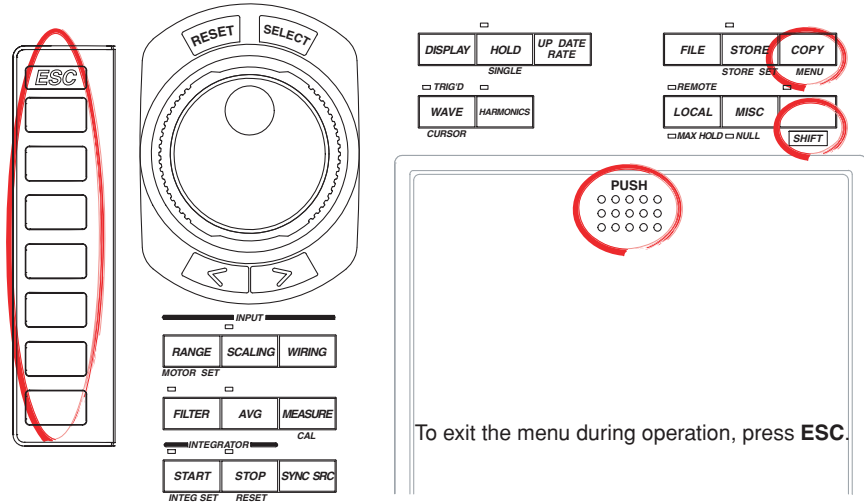

## Procedure

1. Press the section marked as **PUSH** on the **printer cover**. The printer cover opens.

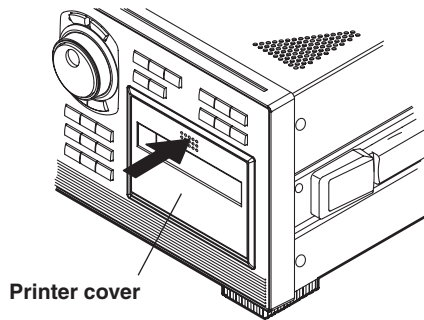

2. Pull up on the **release lever** to the **FREE** position (vertical).

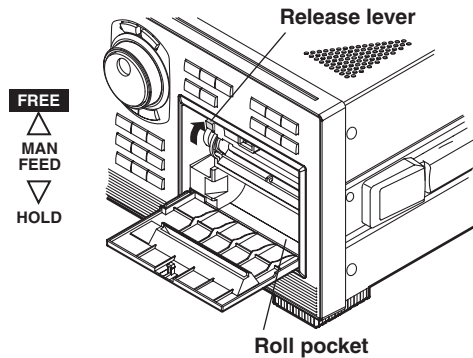

## 14.1 Installing the Paper Roll and Paper Feeding

3. With approximately 13 cm of the **roll paper** unrolled, place the roll paper in the roll pocket in the direction indicated by the figure below.  
If you reverse the direction in which the roll paper is placed, nothing will be printed.
4. Insert the **roll paper** evenly under the paper roller and move the release lever to the HOLD position (horizontal).

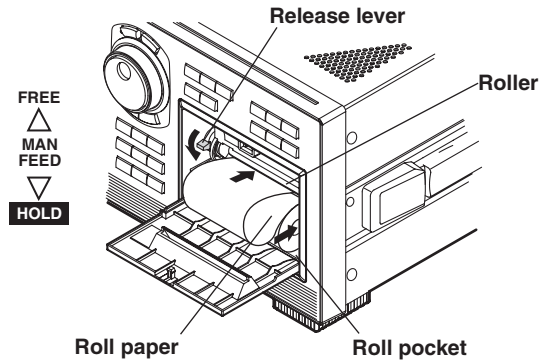

5. Press **SHIFT+COPY (MENU)** to display the Copy menu.
6. Press the **Copy to** soft key to display the Copy to menu.
7. Press the **Printer** soft key.
8. Press the **Paper Feed** soft key. Each time the soft key is pressed, the roll paper is fed approximately 2 cm. Feed the roll paper until approximately 10 cm of paper is showing at the top of the paper roller.  
Check that there are no slacks in the roll paper and that the roll paper is inside the roll pocket.

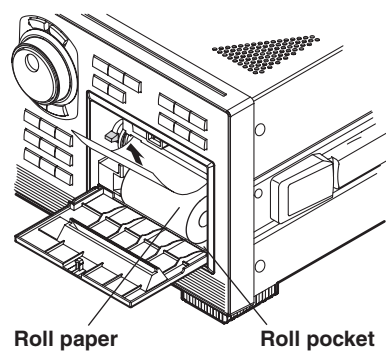
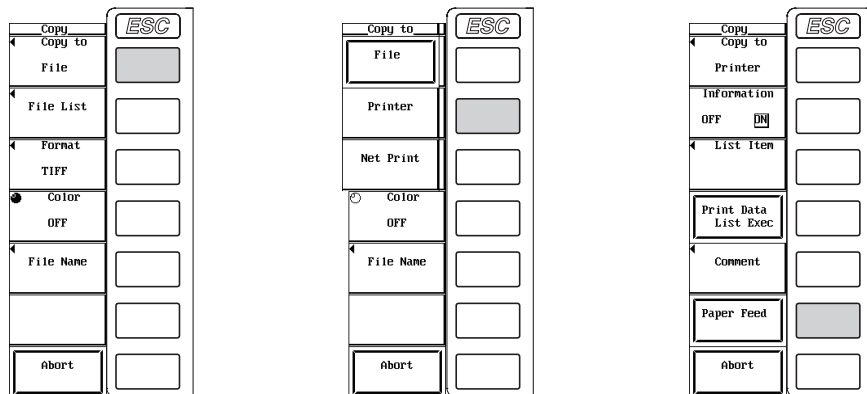

Press the Paper Feed soft key to take up the slack in the paper.

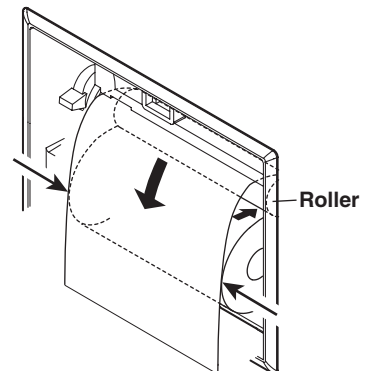

Align the left and right edges of the paper as it exits the printer so that they are even with the sides of the roll.

## 14.1 Installing the Paper Roll and Paper Feeding

9. Insert the **roll paper** that is showing in the slit of the printer cover.

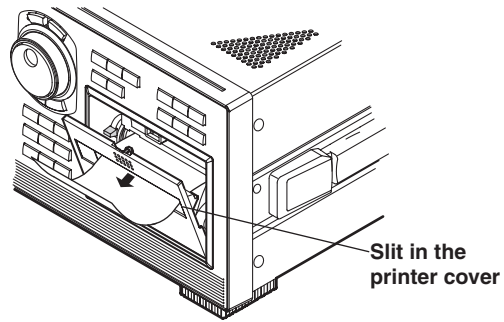

10. Close the **printer cover**. Firmly press the section marked as PUSH until it clicks in place.

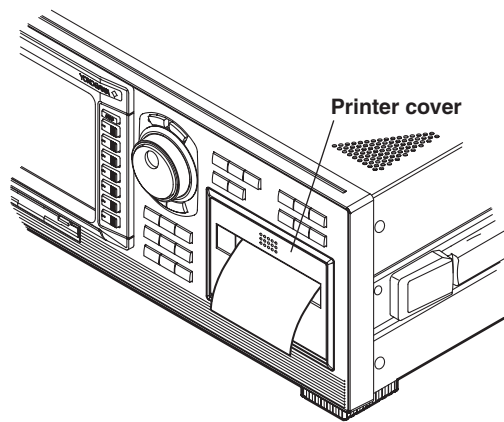

### Explanation

#### Printer Roll Paper

Use only the dedicated roll paper provided by YOKOGAWA. When using the printer for the first time, use the roll paper that is included in the package. Order extra rolls from your nearest YOKOGAWA dealer.

---

Part No.	B9316FX
Specifications	Thermal-sensitive paper, 10 m
Sales unit	10 rolls

---

#### Handling Precautions of the Roll Paper

The paper is a thermal-sensitive paper that changes color with the application of heat. Take note of the following points.

- **Storage precautions**

The paper starts changing color at around 70°C. It is affected by heat, humidity, light, and chemicals regardless of whether the paper has been used or not.

- Store the paper in a cool, dry, and dark place.
- After opening the package, use it quickly.
- If the paper is left in contact with plastic film (such as a vinyl chloride film or Scotch tape) containing plasticizers for an extended time, the paper will lose some of its ability to reproduce color. If you are going to store the paper in a folder, for example, use a folder made of polypropylene.
- When using glue on the paper, do not use a glue containing organic solvents such as alcohol or ether, as they will change the color of the paper.
- For prolonged storage, we suggest you copy the roll chart. Due to the characteristics of the thermal-sensitive paper, the recording section may lose color over time.

- **Precautions on Use**

- Use only genuine paper rolls provided by YOKOGAWA.
- Touching the paper with sweaty hands can leave finger print marks or blur the printing.
- Rubbing the surface with a hard object can cause the paper to change color due to the heat caused by friction.
- Outputting If chemicals, oil, or other liquids come in contact with the paper, the paper may change color or the printing may fade.

#### Note

---

- To cut the paper after the paper roll is installed and the printer cover is closed, pull the roll paper upward against the cover.
  - If you open the printer cover immediately after you cut the roll paper, repeat steps 5 to 10.
  - After installing the roll paper and closing the printer cover, check that the paper is being fed correctly by carrying out step 8. If the paper is not being fed evenly, continue to feed the paper for approximately 30 cm. The paper will straighten out.
  - If you reverse the direction in which the roll paper is placed, the printer head does not make contact with the thermal-sensitive surface. Hence, nothing will be printed.
-



## 14.2 Printing Screen Images

### Keys

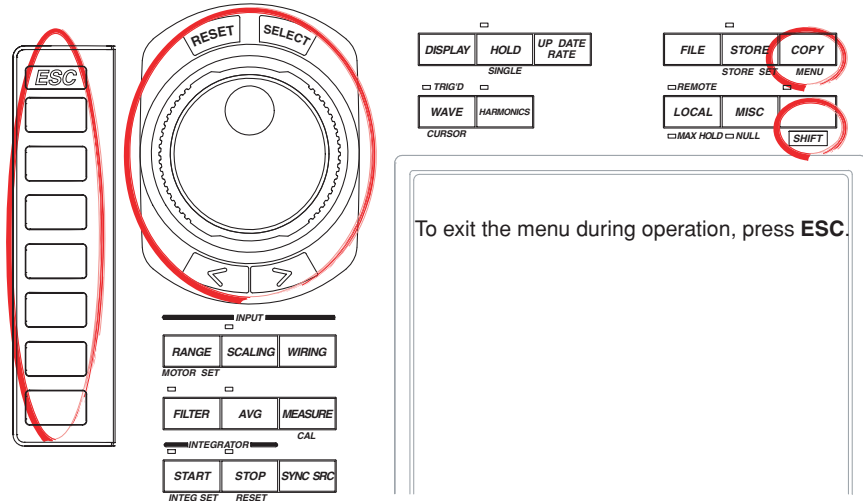

### Procedure

1. Press **SHIFT+COPY (MENU)** to display the Copy menu.
2. Press the **Copy to** soft key to display the Copy to menu.
3. Press the **Printer** soft key.

### Setting Comments

4. Press the **Comment** soft key to display the keyboard.
5. Use the **keyboard** to enter the comment.

For keyboard operations, see section 3.12, "Entering Values and Strings."

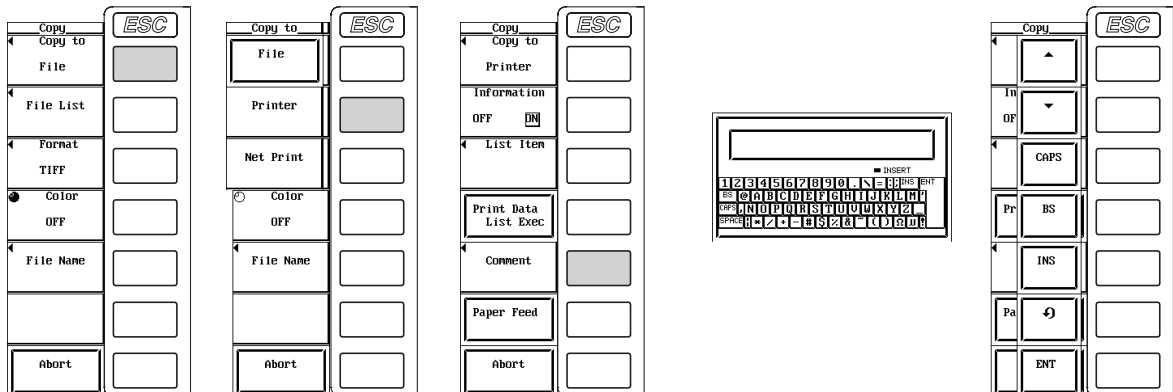

## 14.2 Printing Screen Images

---

### Executing the Print Operation

6. Switch to the screen you wish to print.
7. Press **COPY** to print the screen image.

### Aborting the Print Operation

8. Press the **Abort** soft key in the Copy menu.

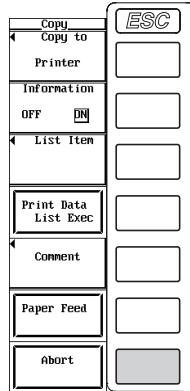

### Explanation

The screen image can be printed on the built-in printer (option).

### Setting Comments

The comment that you entered is displayed at the bottom of the screen. The comment on the screen is also printed as a screen image.

### Number of Characters and Types That Can Be Used

Item	Number of Characters	Characters That Can Be Used
Comment	0 to 25* characters	Characters that are displayed on the keyboard and spaces

\* You can enter up to 25 characters for the comment, but only the first 20 characters are displayed on the screen.

# 14.3 Printing Numerical Data Lists and Bar Graphs

## Keys

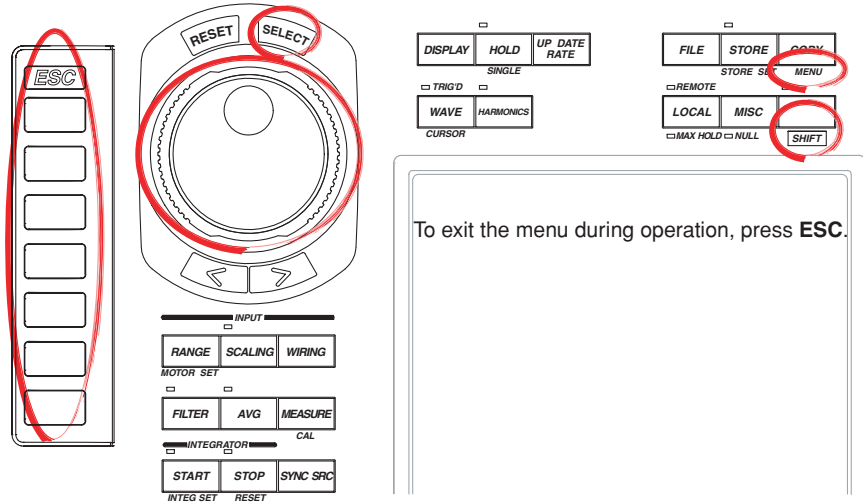

## Procedure

1. Press **SHIFT+COPY (MENU)** to display the Copy menu.
2. Press the **Copy to** soft key to display the Copy to menu.
3. Press the **Printer** soft key.

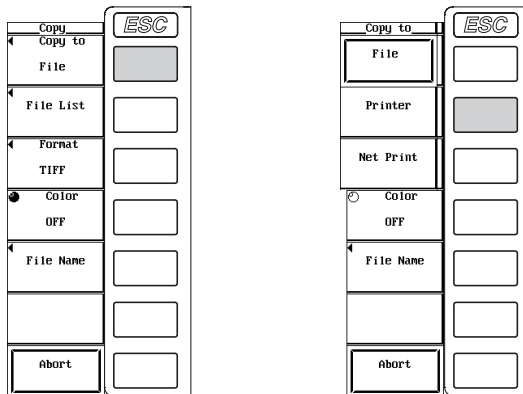

### Printing or Not Printing (ON/OFF) the Header Information

4. Press the **Information** soft key to select ON or OFF.

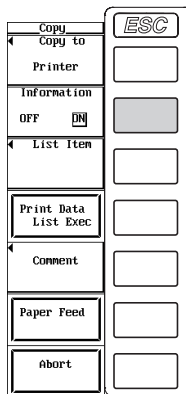

**During Normal Measurement**

5. Press the **List Item** soft key to display the List Item dialog box.

**Selecting the Numerical Data to Be Printed**

- **Selecting the items at once**
  6. Turn the **jog shuttle** to select All ON.
  7. Press **SELECT**. The buttons to the left of all the elements and measurement functions are highlighted indicating that all items will be printed.
- **Deselecting all the items at once**
  6. Turn the **jog shuttle** to select All OFF.
  7. Press **SELECT**. The highlighting of the buttons to the left of all the elements and measurement functions are cleared indicating that all items will not be printed.

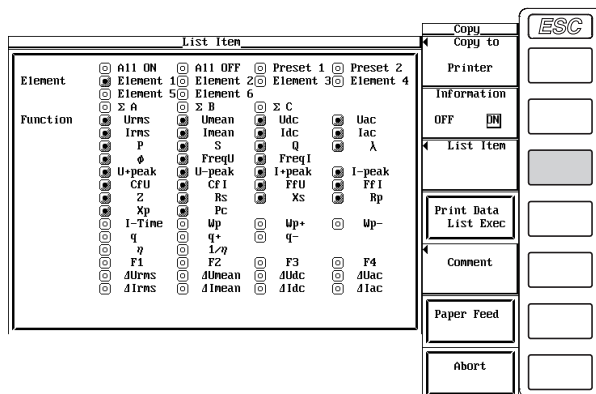

- **Selecting only the items that are preset**

6. Turn the **jog shuttle** to select Preset1 or Preset2.
7. Press **SELECT**. The buttons to the left of all the elements and measurement functions that are specified in Preset1 or Preset 2 are highlighted indicating that the items will be printed.

**Items specified in Preset1**

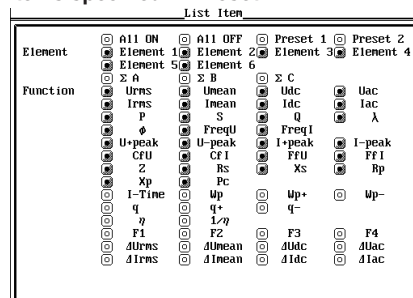

**Items specified in Preset2**

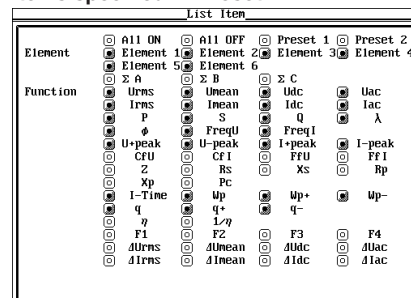

- **Setting the items one at a time**

6. Turn the **jog shuttle** to select the element or measurement function that you wish to specify.
7. Press **SELECT**. When the button to the left of the selected element or measurement function is highlighted, the numerical data of the measurement function of the element will be printed. When the highlighting of the button is cleared, the numerical data of the measurement function of the element will not be printed.

Proceed to step 10.

**During Harmonic Measurement**

5. Press the **List Item** soft key to display the List Item dialog box.

**Selecting the Numerical Data to Be Printed**

6. Turn the **jog shuttle** to select Numeric/Bar.
7. Press **SELECT** to select Numeric.
8. Turn the **jog shuttle** to select the element or measurement function that you wish to specify.
9. Press **SELECT**. When the button to the left of the selected element or measurement function is highlighted, the numerical data of the measurement function of the element will be printed. When the highlighting of the button is cleared, the numerical data of the measurement function of the element will not be printed.

**Selecting the Bar Graph to Be Printed**

6. Turn the **jog shuttle** to select Numeric/Bar.
7. Press **SELECT** to select Bar.
8. Turn the **jog shuttle** to select the element or measurement function that you wish to specify.
9. Press **SELECT**. When the button to the left of the selected element or measurement function is highlighted, the numerical data of the measurement function of the element will be printed. When the highlighting of the button is cleared, the numerical data of the measurement function of the element will not be printed.

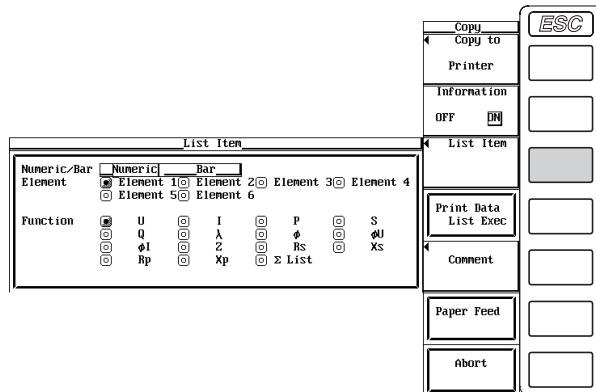

### Executing/Aborting the Print Operation

10. Press **ESC** to close the List Item dialog box.

#### Executing the Print Operation

11. Press the **Print Data List Exec** soft key. The numerical data list is printed.

#### Aborting the Print Operation

12. Press the **Abort** soft key in the Copy menu.

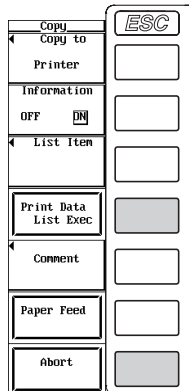

### Explanation

#### During Normal Measurement

##### Header Information

- Only installed elements are applicable for the selection.
- The following items are available as header information.
  - Measurement mode (Normal)
  - Data update rate
  - Date, time
  - Measurement range of each element

##### Turning ON/OFF Header Information Printing

- ON: Prints the header information.
- ON: Does not print the header information.

##### Selecting the Numerical Data

- Only installed elements and wiring units are applicable for the selection.
- The numerical data can be selected from the items that are indicated in "Measurement Function Types during Normal Measurement" and "Measurement Function Types for Motor Evaluation Function (Option)" in section 1.2; "Delta Computation," "User-Defined Functions," and "Corrected Power" in section 1.5; and "Measurement Functions of Integration" in section 1.6.

##### Print Format of the Numerical Data List

- The selected numerical data items are printed.
- Prints a list consisting of elements in the horizontal direction and measurement functions in the vertical direction.

## During Harmonic Measurement

### Header Information

- Only installed elements are applicable for the selection.
- The following items are available as header information.
  - Measurement mode (Harmonics)
  - Date, time
  - PLL Source
  - $f_U$ ,  $f_I$
  - Phase difference of the fundamental wave ( $\phi_{U1-U2}$ ,  $\phi_{U1-U3}$ ,  $\phi_{U1-I1}$ ,  $\phi_{U1-I2}$ , and  $\phi_{U1-I3}$ )
  - Measurement range of each element
  - Total of U, I, P, S, Q,  $\lambda$ , and  $\phi$  of each element
  - $U_{thd}$ ,  $I_{thd}$ ,  $P_{thd}$ ,  $U_{thf}$ ,  $I_{thf}$ ,  $U_{tif}$ ,  $I_{tif}$ ,  $h_{vf}$ , and  $h_{cf}$  of each element

### Turning ON/OFF Header Information Printing

- ON: Prints the header information.
- OFF: Does not print the header information.

### Selecting Numerical Data and Bar Graph

You can select numerical data or bar graph to be printed.

- Only installed elements are applicable for the selection.
- The numerical data can be selected from U (including  $U_{hdf}$ ), I (including  $I_{hdf}$ ), P (including  $P_{hdf}$ ), S, Q,  $\lambda$ ,  $\phi$ ,  $\phi_U$ ,  $\phi_I$ , Z, Rs, Xs, Rp, Xp, and  $\Sigma$ List.
- The bar graph can be selected from U, I, P, S, Q,  $\lambda$ ,  $\phi$ ,  $\phi_U$ ,  $\phi_I$ , Z, Rs, Xs, Rp, Xp,  $U_{hdf}$ ,  $I_{hdf}$ , and  $P_{hdf}$ .
- The range of harmonic order is the range specified by Min Order and Max Order in section 7.5.

### Print Format of Numerical Data Lists and Bar Graphs

- The selected numerical data or bar graph items are printed.
- Prints a list consisting of elements and measurement functions in the horizontal direction and harmonic order in the vertical direction.

# 15.1 Setting the D/A Output (Option)

## Keys

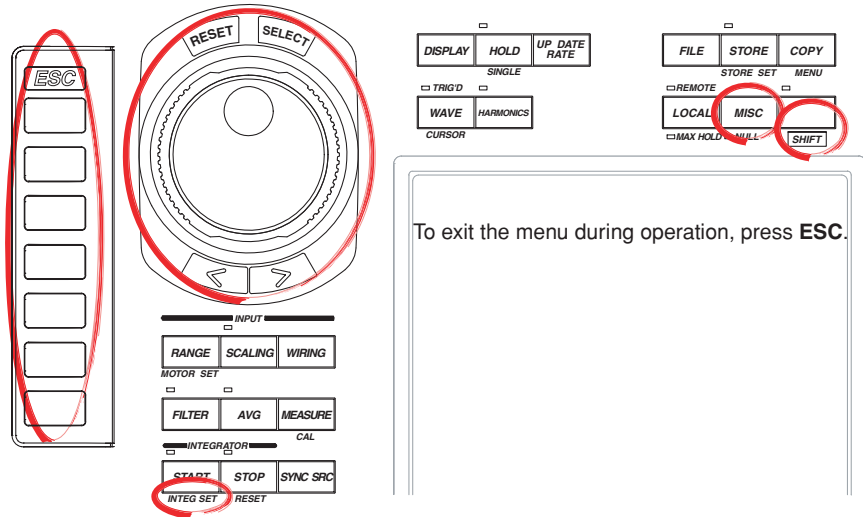

## Procedure

1. Press **MISC** to display the Misc menu.
2. Press the **Next 1/2** soft key to display the Next 2/2 menu.
3. Press the **D/A Output Items** soft key to display the D/A Output menu.

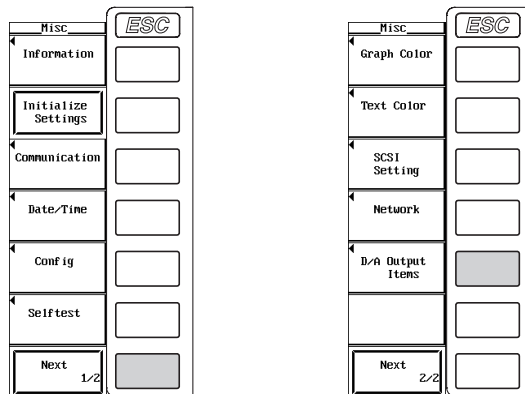



### Setting the D/A Output Items during Normal Measurement

#### Selecting the Target Channel

4. Turn the **jog shuttle** to select 1 to 30.

#### Selecting the Measurement Function

5. Press the **Function** soft key to display the measurement function selection box.
6. Turn the **jog shuttle** to select any of the measurement function starting with None.
7. Press **SELECT** to confirm.

#### Selecting the Element/Wiring Unit

8. Press the **Element** soft key to display the element/wiring unit selection box.
9. Turn the **jog shuttle** to select any of the elements/wiring units starting with Element1.
10. Press **SELECT** to confirm.

Proceed to step 14.

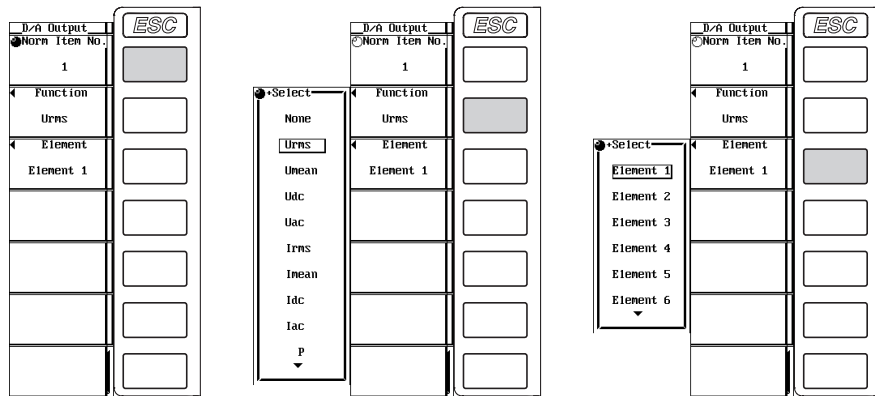

### Setting the D/A Output Items during Harmonic Measurement

#### Selecting the Target Channel

4. Press the **Harm Item No.** soft key.
5. Turn the **jog shuttle** to select 1 to 30.

#### Selecting the Measurement Function

6. Press the **Function** soft key to display the measurement function selection box.
7. Turn the **jog shuttle** to select any of the measurement function starting with None.
8. Press **SELECT** to confirm.

#### Selecting the Element/Wiring Unit

9. Press the **Element** soft key to display the element/wiring unit selection box.
10. Turn the **jog shuttle** to select any of the elements/wiring units starting with Element1.
11. Press **SELECT** to confirm.

#### Selecting the Harmonic Order

12. Press **Order** soft key.
13. Turn the **jog shuttle** to select the order from Total and 0 to the maximum harmonic order (see section 7.5).

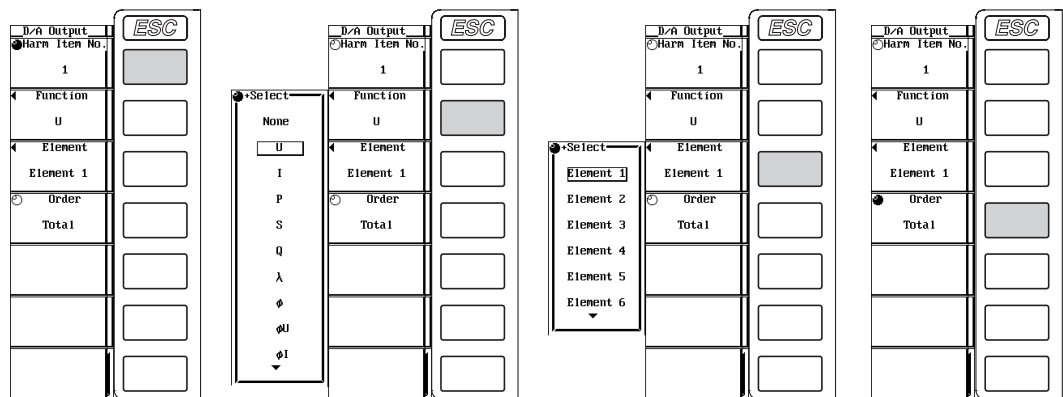

## 15.1 Setting the D/A Output (Option)

### Setting the Rated Time of Integrated D/A Output

14. Press **SHIFT+START (INTEG SET)** to display the Integ Set menu.
15. Press the **D/A Output Rated Time** soft key to display the D/A Rated Time dialog box.
17. Turn the **jog shuttle** to select one of the hour, minute, and second boxes.
18. Press **SELECT** to display the entry box.
19. Turn the **jog shuttle** to set the hour, minute, or second that you selected in step 17.  
For the procedures on how to enter values using the jog shuttle, see section 3.12, "Entering Values and Strings."
20. Press **SELECT** or **ESC** to close the box.
21. Repeat steps 17 to 20 to set hour, minute, and second.

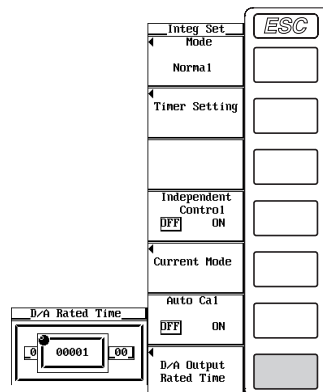

**Explanation**

The numerical data can be output using  $\pm 5$ -V FS DC voltage from the D/A output connector on the rear panel. Up to 30 items (channels) can be specified for each measurement mode, normal and harmonic.

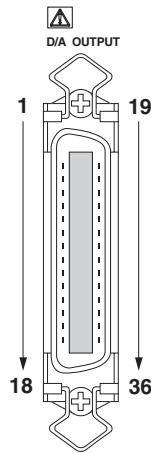
**Pin Arrangement and Signal Assignment of the D/A Output Connector**

The pin arrangement and assignments of the connector are as follows:

Pin No.	Signal Name	Pin No.	Signal Name
1	D/A CH1	19	D/A CH2
2	D/A CH3	20	D/A CH4
3	D/A CH5	21	D/A CH6
4	D/A CH7	22	D/A CH8
5	D/A CH9	23	D/A CH10
6	D/A CH11	24	D/A CH12
7	D/A CH13	25	D/A CH14
8	D/A CH15	26	D/A CH16
9	D/A CH17	27	D/A CH18
10	D/A CH19	28	D/A CH20
11	D/A CH21	29	D/A CH22
12	D/A CH23	30	D/A CH24
13	D/A CH25	31	D/A CH26
14	D/A CH27	32	D/A CH28
15	D/A CH29	33	D/A CH30
16	D/A GND	34	D/A GND
17	D/A GND	35	D/A GND
18	—	36	—

**Note**

D/A GND (pins 16, 17, 34, and 35) are connected internally to the case.

**CAUTION**

Do not short the D/A output terminal or apply external voltage to it. This may cause damage to the instrument.

**D/A Output Items during Normal Measurement****Selecting the Measurement Function**

- The types of measurement functions that can be selected are the items that are indicated in “Measurement Function Types during Normal Measurement” and “Measurement Function Types for Motor Evaluation Function (Option)” in section 1.2; “Delta Computation,” “User-Defined Function,” and “Corrected Power” in section 1.5; and “Measurement Functions of Integration” in section 1.6.
- You can also select not to output the measurement functions (None). For channels that are set to None, 0 V is output since no corresponding data exists.
- If you selected measurement functions of delta computation, the meanings of the elements described in the next section are different from when other measurement functions are selected. For details, see the explanation in section 6.1.

**Selecting the Element/Wiring Unit**

- You can select the element/wiring unit from the following list of choices. The selectable items vary depending on the installed elements.  
Element1, Element2, Element3, Element4, Element5, Element6,  
 $\Sigma A$ ,  $\Sigma B$ , and  $\Sigma C$

## 15.1 Setting the D/A Output (Option)

---

- If there are no elements that are assigned to the selected wiring unit, there is no numerical data. Thus, 0 V is output in this case. For example, if elements are assigned to  $\Sigma A$  and  $\Sigma B$  and no elements are assigned to  $\Sigma C$ , then the measurement function for  $\Sigma C$  output 0 V.

### D/A Output Items during Harmonic Measurement

#### Selecting the Measurement Function

- The types of measurement functions that can be selected are indicated in “Measurement Function Types for Harmonic Measurement” in section 1.2 and “User-Defined Functions” in section 1.5.
- You can also select not to output the measurement functions (None). For channels that are set to None, 0 V is output since no corresponding data exists.
- The DA output is fixed at 0 for channels on which Z, Rs, Xs, Rp, Xp, Utif, Itif, F1, F2, F3, or F4 were selected as the measurement function.

#### Selecting the Element/Wiring Unit

- You can select the element/wiring unit from the following list of choices. The selectable items vary depending on the installed elements.  
Element1, Element2, Element3, Element4, Element5, Element6,  
 $\Sigma A$ ,  $\Sigma B$ , and  $\Sigma C$
- If the selected wiring unit is not a harmonic measurement target, there is no numerical data. Thus, 0 V is output in this case. For example, if the measurement target is  $\Sigma A$ , 0 V is output at the measurement function of  $\Sigma C$ . For selecting the measurement target, see section 7.3.

#### Changing the Harmonic Order

The harmonic order can be set to total or from dc (0th order) up to 100th order.

#### Note

---

- For the meanings of the measurement function symbols that are output, see section 1.2, “Measurement Functions and Measurement Periods,” 1.5, “Computation,” 1.6, “Integration,” appendix 1, “Symbols and Determination of Measurement Functions,” and appendix 2, “Determination of Delta Computation.”
- For details on the wiring units expressed as  $\Sigma A$ ,  $\Sigma B$ , and  $\Sigma C$ , see section 5.1, “Selecting the Wiring System.”
- 0 V is output in places where the measurement function is not selected or where numerical data is not present..
- The harmonic order can be set to total or from dc (0th order) up to 100th order. However, the numerical data up to the order corresponding to the upper limit of harmonic order under analysis (see section 17.6) that is automatically determined from the minimum analysis order specified in section 7.5 to the PLL source frequency is the data determined by the harmonic measurement. For harmonic orders less than the minimum analysis order specified in section 7.5 (for example, 0th order when Min Order is set to 1st order) and those greater than the maximum analysis order, the output is 0 V.
- If scaling factors such as PT ratio, CT ratio, and power coefficient are specified on the voltage, current, and power, and the scaling is ON, 100% (5 V) is output when the scaled value is equal to the scaled rated value (measurement range  $\times$  scaling factor).
- For  $\Sigma$  functions, 100% (5 V) is output when the input is equal to the total value that is obtained when the rated value is input to each corresponding element. If different scaling factors are placed on each element, 100% (5 V) is output when the scaled value is equal to the scaled rated value (measurement range  $\times$  scaling factor).
- If numerous D/A output items are specified (other than None), it may take some time before the built-in printer starts printing. In this case, reduce the number of output items or hold the measurement (see section 5.8).

### Rated Time of Integrated D/A Output

In the case of integrated values, the integrated value that is obtained while continuously applying a rated value (same value as the measurement range) for the specified time is taken to be 100%. The D/A output at that point is 5 V. The D/A output from the integrated value of 0 (0 V) to the integrated value of 100% (5 V) is assumed to change linearly with time. The D/A output value is determined by the level of the actual input with respect to this assumed line (see the figure on the next page).

#### Setting the Rated Time of Integrated D/A Output

- Set the time in units of hour : minute : second in the following range.  
0000:01:00 to 10000:59:59
- This setting is valid in the manual integration mode.
- For normal integration and repetitive integration modes (includes real-time), the time specified for the timer is the rated time of integrated D/A output.

#### Note

You cannot specify a time less than 1 minute to the rated time of integrated D/A output.

### Relationship between the Output Items and D/A Output Voltages

#### Frequency

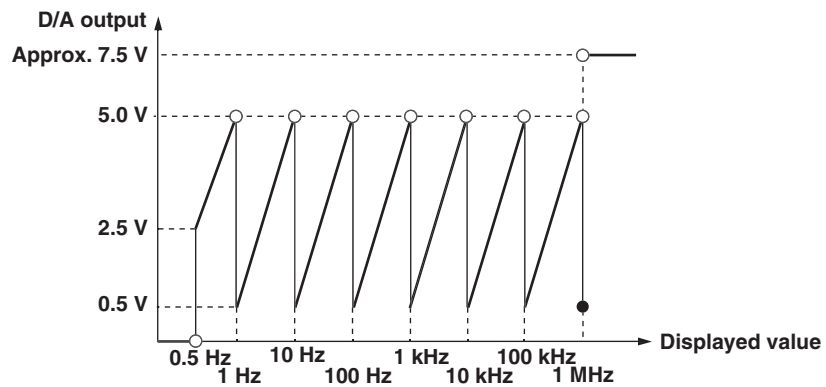

#### Integrated Value

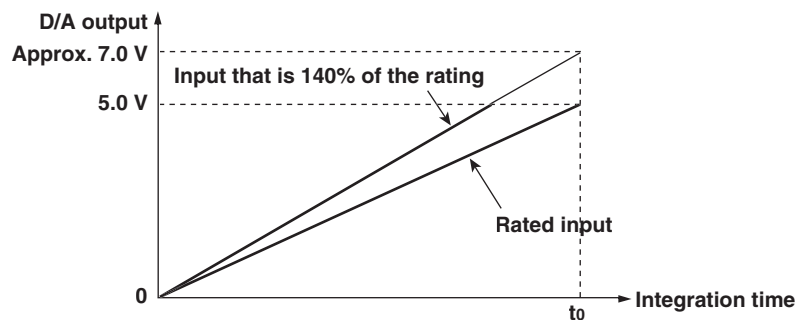

to: Rated time of integrated D/A output for manual integration mode, specified time of timer for normal integration and repetitive (continuous) integration modes

## 15.1 Setting the D/A Output (Option)

### Other Items

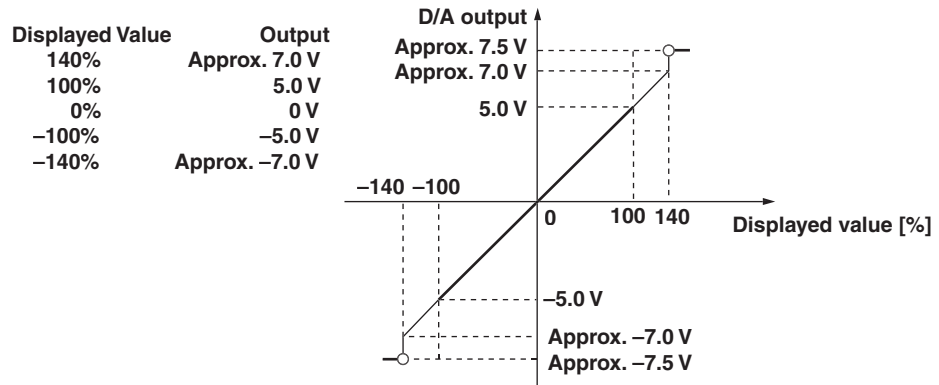

- $\lambda$  and  $\phi$  are not output outside  $\pm 5$  V. When the display format of  $\phi$  is 360 degrees (360° format),  $\phi$  is output in the range of 0 V to +5 V. When the display format of  $\phi$  is 180 Lead/lag (180° lag to 180° lead),  $\phi$  is output in the range of -5 V to +5 V. However, approximately 7.5 V is output when an error occurs. For U-pk and I-pk only, approximately -7.5 V is output when an error occurs.
- For  $\eta$ ,  $1/\eta$ , Uhd, lhdf, Phdf, Uthd, lthd, Pthd, Uthf, lthf, hvf, hcf, Slip\*,  $\eta mA^*$ , and  $\eta mB^*$ , +5 V is output when the measured value is equal to 100%.
- For Utif and Itif, +5 V is output when the measured value is equal to 100.
- For Torque\*, +5 V is output when the measured value is equal to a value (rated value) of "input range"  $\times$  "torque scaling factor." For example, with an input range of 10 V, if the scaling factor is set to 1 N·m torque per 1 V input voltage, +5 V is output when torque is 10 N·m.
- For Speed\*, when the revolution signal is an analog signal, +5 V is output when the measured value is equal to a value (rated value) of "input range" of the analog signal  $\times$  "scaling factor of rotating speed." For example, with an input range of 10 V, if the scaling factor is set to 100 rpm rotating speed per 1 V input voltage, +5 V is output when the rotating speed is 1000 rpms.
- For Speed\*, when the revolution signal is a pulse signal, +5 V is output when the measured value is equal to the Pulse Range value (rated value) that was specified in section 8.2.
- For Sync\*, +5 V is output when the measured value is equal to the rated value of Speed.
- For Pm\*, +5 V is output when the measured value is equal to a motor output determined by the rated value of the torque and of the rotating speed.

\* Applicable only to products with the motor evaluation function (option).

## 15.2 RGB Video Signal (VGA) Output

The screen of the WT1600 can be output to a monitor through the RGB video signal (VGA) output. Connectable monitors are VGA monitors or multi-sync monitors capable of displaying VGA.

### CAUTION

- Connect the cable after turning OFF the WT1600 and the monitor.
- Do not short the RGB VIDEO OUT terminal or apply external voltage to it. This may cause damage to the instrument.

### Pin Arrangement and Signal Assignment of the Video Signal Output Connector

The pin arrangement and assignments of the connector are as follows:

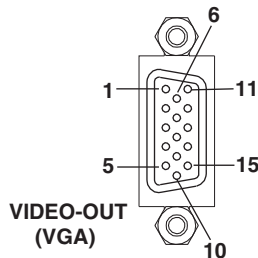

Pin No.	Signal Name	Specifications
1	Red	0.7 Vp-p
2	Green	0.7 Vp-p
3	Blue	0.7 Vp-p
4	—	
5	—	
6	GND	
7	GND	
8	GND	
9	—	
10	GND	
11	—	
12	—	
13	Horizontal sync signal	Approx. 31.5 kHz, TTL $\overline{\square}$ (negative logic)
14	Vertical sync signal	Approx. 60 Hz, TTL $\overline{\square}$ (negative logic)
15	—	

### Connecting to the Monitor

1. Turn OFF the **power** to the WT1600 and the monitor.
2. Connect the WT1600 and the monitor using an analog RGB **cable**.
3. The screen of the WT1600 appears on the monitor when the **power** to both the WT1600 and the monitor are turned ON.

### Note

- The RGB video signal is constantly output from the video signal output connector.
- The monitor screen may flicker if the WT1600 or another device is brought close to the monitor.
- The edge of the screen may drop out depending on the monitor type.



## 15.3 Initializing the Settings

### Keys

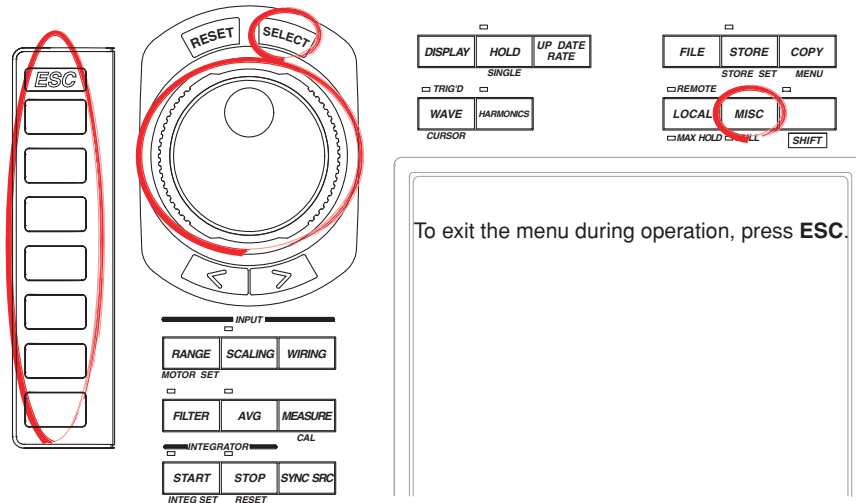

To exit the menu during operation, press **ESC**.

### Procedure

#### Note

Check that it is okay to initialize the settings before actually initializing the settings. You cannot set the settings back after initialization. It is recommended that the setup parameters be saved (see section 12.6) before initialization.

1. Press **MISC** to display the Misc menu.
2. Press the **Initialize Settings** soft key. An Alert dialog box appears.
3. Turn the **jog shuttle** to select OK or Cancel.
4. Select OK and press **SELECT** to execute the initialization.  
Select Cancel and press **SELECT** to abort the initialization.

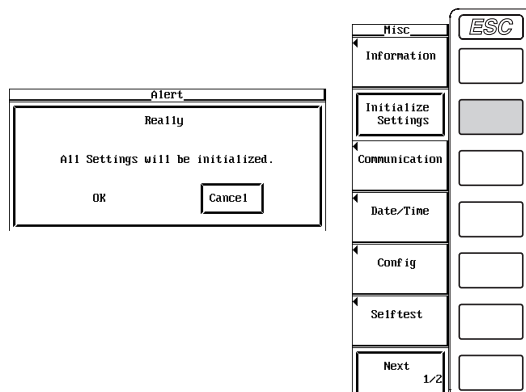

**Explanation**

The values specified by the panel keys can be reset to the factory default values. This is useful when you wish to clear previous settings or start the settings from scratch. For details on the initial settings, see appendix 3, "List of Initial Settings and Display Order of Numerical Data."

**Settings That Cannot Be Initialized**

- Date and time settings
- Settings related to saving and loading data.
- Settings related to screen image output.
- Settings related to the GP-IB interface, serial interface, and Ethernet interface.
- SCSI ID number setting (SCSI is optional.).

**Initializing at Power Up**

If the power switch is turned ON while pressing RESET, the WT1600 powers up using initial settings. In this case, "Settings That Cannot Be Initialized" as indicated above excluding the date and time are also initialized.

## 15.4 Performing Zero-Level Compensation

### Keys

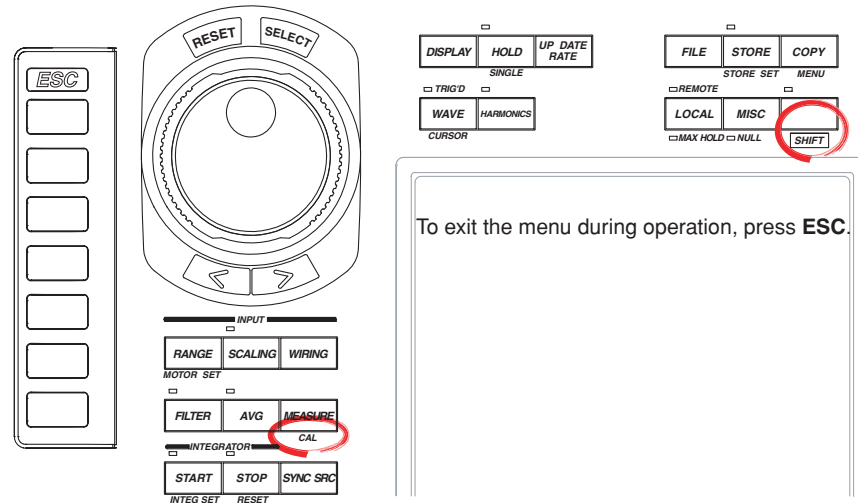

### Procedure

Press **SHIFT+MEASURE (CAL)** to execute zero-level compensation.

### Explanation

#### Zero-Level Compensation

This function is used to create a zero input condition using the internal circuit of the instrument and setting the level at that point to zero level. Zero-level compensation must be performed to meet the specifications of this instrument (see chapter 17).

- Pressing CAL executes the zero-level compensation.
- Zero-level compensation is performed the first time the measurement is made after turning ON/OFF harmonic measurement or changing the measurement range or input filter.

#### Note

- For making accurate measurements, it is recommended that zero-level compensation be performed after warming up the instrument for at least an hour. In addition, the ambient temperature need to be within the specifications (see chapter 17) and stable.
- If the harmonic measurement ON/OFF setting, measurement range, and input filter are not changed over a long period of time, the zero level may change due to the changes in the environment surrounding the instrument. It is recommended that zero-level compensation be performed in this case.
- There are functions that automatically perform zero-level compensation during integration. See section 6.10.

## 15.5 Using the NULL Function

### Keys

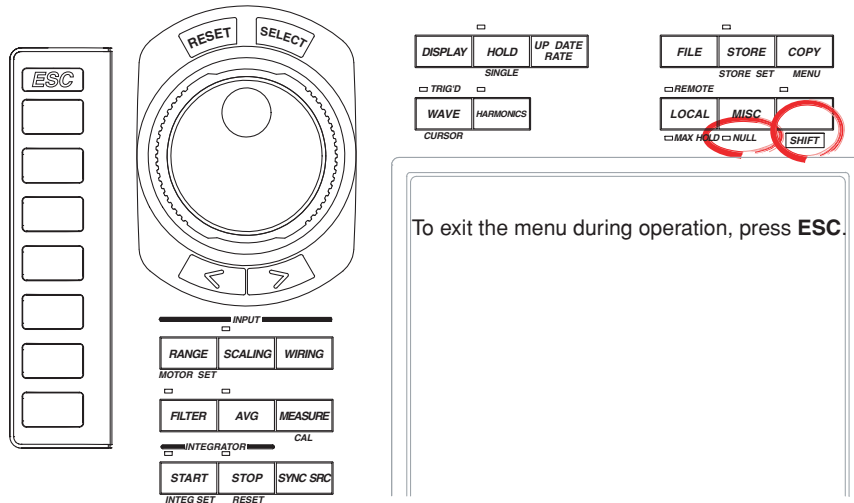

### Procedure

#### Activating the NULL Function

1. Press **SHIFT+MISC (NULL)**. The NULL indicator that is below and to the left of the key illuminates and the NULL function is activated.

#### Clearing the NULL Function

2. Press **SHIFT+MISC (NULL)** when the NULL function is activated. The NULL indicator turns OFF and the NULL function is canceled.

### Explanation

The NULL function can be used to subtract the DC offset while the external sensor or measurement cable is connected. Execute the NULL function at zero input condition (current input terminal open and voltage input terminal shorted).

#### Null Value

When the NULL function is turned ON, the NULL values are set to the Udc and Idc values (numerical data of the simple average of the voltage and current during normal measurement), Speed and Torque (on products with the motor evaluation function when the input signal from the sensor is an analog signal) that were measured the previous time. If the previously measured Udc and Idc as well as Speed and Torque values do not exist, such as when the NULL function is turned ON without making a measurement after turning ON the power, Udc and Idc are set to zero.

#### Note

- The NULL function is automatically cleared when the range or filter setting is changed or when the harmonic mode is turned ON/OFF.
- If the crest factor is set to 3, a NULL value of approximately 50% is set for a signal that exceeds 50% of the range. If the crest factor is set to 6, a NULL value of approximately 100% is set for a signal that exceeds 100% of the range.

#### Measurement Function Affected by the NULL Function

The NULL value is subtracted from the sampled data. Hence, all measurement functions are affected by the NULL values.

# 15.6 Selecting the Message Language and the Screen Brightness

## Keys

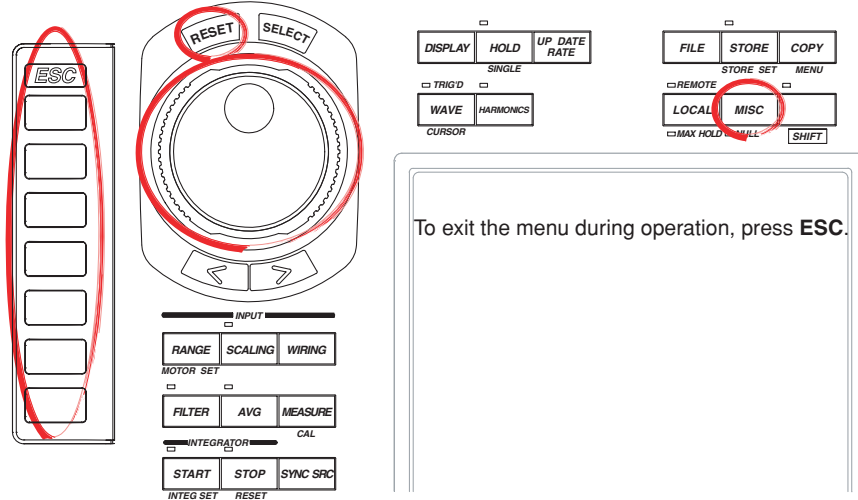

## Procedure

1. Press **MISC** to display the Misc menu.
2. Press the **Config** soft key to display the Config menu.

### Selecting the Message Language

3. Press the **Message** soft key to display the Message menu.
4. Press the **JPN**, **ENG**, or **CHN** soft key to select the message language.

### Selecting the Screen Brightness

3. Turn the **jog shuttle** to select -1 to 3.

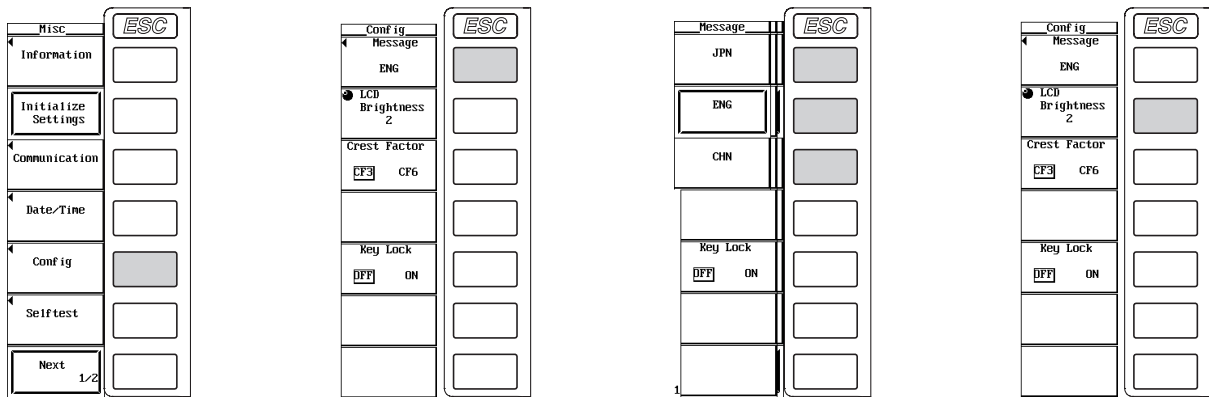

### Explanation

#### Selecting the Message Language

An error message is displayed when an error occurs. Select the language to use to display the message and the menu from the choices below. The error codes for the error messages are the same. For details on the error messages, see section 16.2.

- JPN  
Displays the messages in Japanese.
- ENG  
Displays the messages in English.
- CHN  
Displays the messages in Chinese.

#### Selecting the Screen Brightness

Select the screen brightness in the range of -1 to 3. The darkest setting is -1 and the brightest setting is 3.

# 15.7 Setting the Display Color of the Screen

## Keys

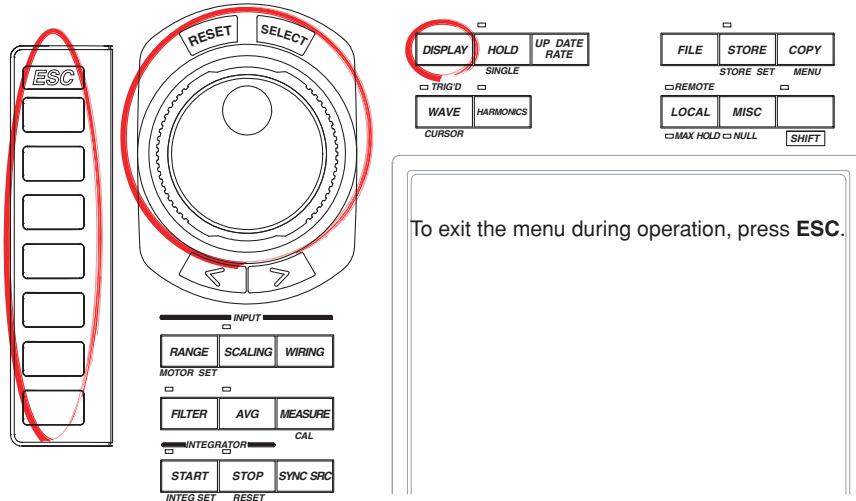

To exit the menu during operation, press **ESC**.

## Procedure

1. Press **MISC** to display the Misc menu.
2. Press the **Next 1/2** soft key to display the Next 2/2 menu.

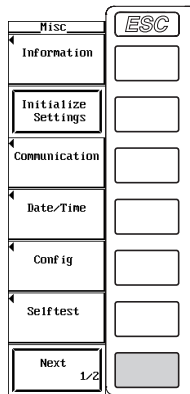

### Setting the Graphic Color

- **Selecting default or user**
3. Press the **Graph Color** soft key to display the Graph Color menu.
  4. Turn the **jog shuttle** to select Default or User.

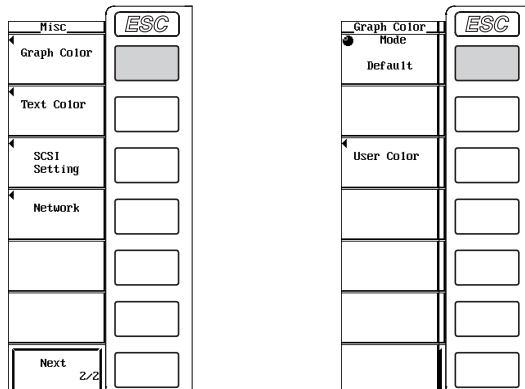

• **Setting user colors**

3. Press the **User Color** soft key to display the Graph Color dialog box.
4. Turn the **jog shuttle** to select the item you wish to set.
5. Press **SELECT** to display the color level selection box.
6. Turn the **jog shuttle** to set the color level.  
For the procedures on how to enter values using the jog shuttle, see section 3.12, "Entering Values and Strings."
7. Press **SELECT** or **ESC** to close the box.

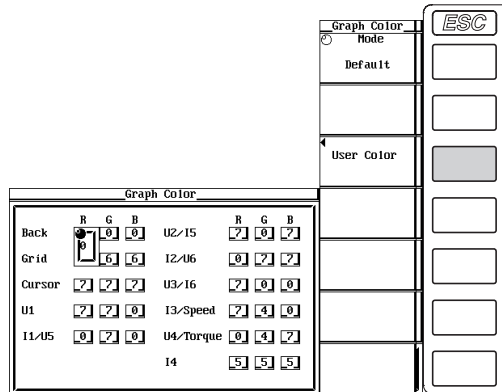

**Setting the Text Color**

• **Selecting preset or user**

3. Press the **Text Color** soft key to display the Text Color menu.
4. Turn the **jog shuttle** to select Preset1 to User.

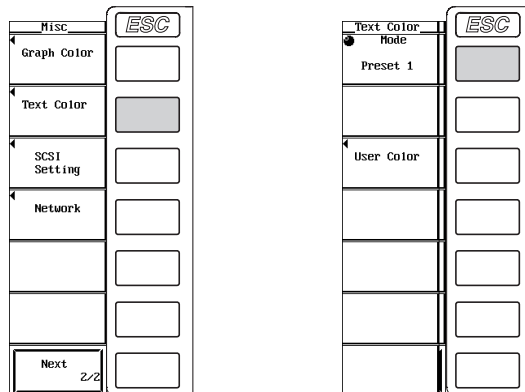

• **Setting user colors**

3. Press the **User Color** soft key to display the Text Color dialog box.
4. Turn the **jog shuttle** to select the item you wish to set.
5. Press **SELECT** to display the color level selection box.
6. Turn the **jog shuttle** to set the color level.  
For the procedures on how to enter values using the jog shuttle, see section 3.12, "Entering Values and Strings."
7. Press **SELECT** or **ESC** to close the box.



## 15.7 Setting the Display Color of the Screen

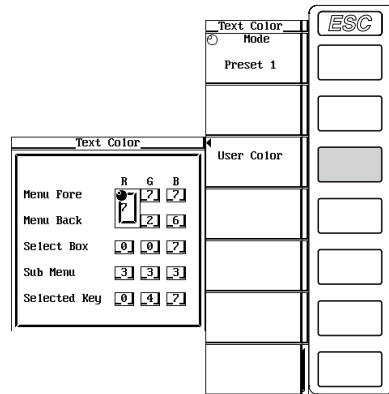

### Explanation

The display color for each item can be specified. Set the color using a ratio (0-7) of red (R), green (G), and blue (B).

### Setting the Graphic Color

Select default color or user color.

For user color, the display color can be specified for each item.

- Back  
Set the background color within the waveform display frame.
- Grid  
Set the color of the grid within the waveform display frame and the area within the waveform display frame.
- Cursor  
Set the display color of the cursor.
- U1 to I6, Speed\*, Torque\*  
Set the display color of the waveform. I1 and U5, U2 and I5, I2 and U6, U3 and I6, I3 and Speed, and U4 and Torque will have the same display color setting.

\* Applicable only on products with the motor evaluation function (option).

### Setting the Text Color

Select from Preset1 to 3 and user setting.

For user color, the display color can be specified for each item.

- Menu Fore  
Set the color of the text on the menu, dialog box, window, and other screens.
- Menu Back  
Set the background color of the waveform display frame.
- Select Box  
Set the background color of the background within the selected menu frame and box.
- Sub Menu  
Set the display color of the selected dialog box or window.
- Selected Key  
Set the display color of the selected soft key or item.

# 15.8 Setting Key Lock

## Keys

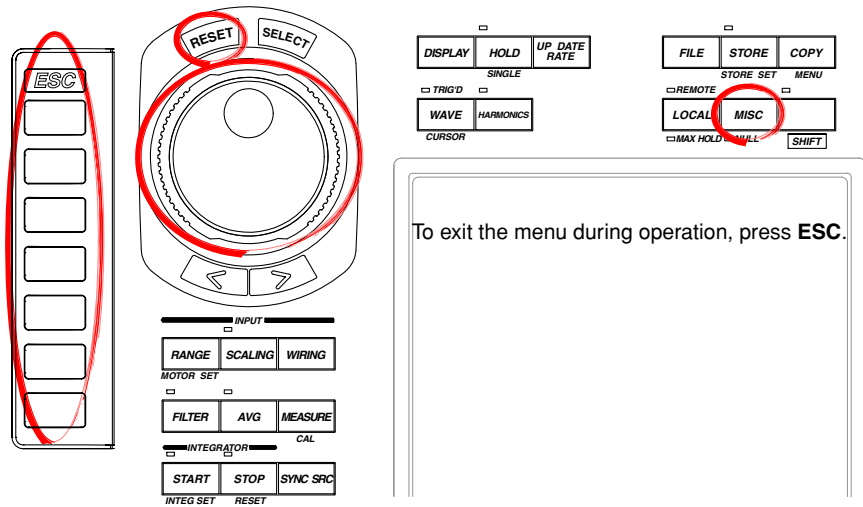

## Procedure

1. Press **MISC** to display the Misc menu.
2. Press the **Config** soft key to display the Config menu.

### Setting Key Lock

3. Press the **Key Lock** soft key to select ON or OFF.

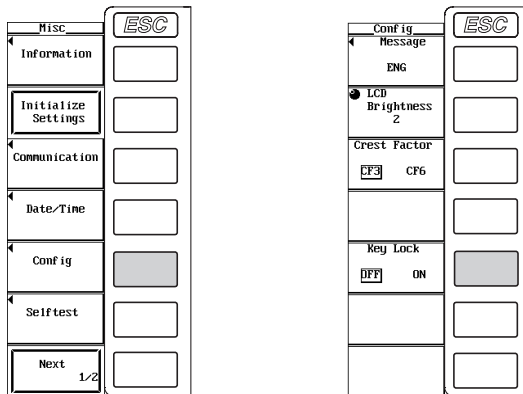

## Explanation

### Key Lock

If key lock is turned ON, all keys except the power switch, MISC key, ESC key, and the 5th soft key from the top are disabled.

When key lock is ON, the word "Lock" blinks at the upper right corner of the screen.

### Note

Key lock ON/OFF setting is held even when the power is turned OFF.

# 16.1 Troubleshooting

## Troubleshooting

- If a message is displayed on the screen, read the succeeding pages.
- If servicing is necessary, or if the instrument is not operating correctly after performing the corrective actions below, contact your nearest YOKOGAWA dealer.

Problem and Corrective Action	Sections
Nothing shows up on the display when the power switch is turned ON.	
Securely connect the power cord to the power connector of the instrument and the power outlet.	3.5
Set supply voltage within the permitted range.	3.5
Check the display settings.	15.7
Check that the fuse is not blown.	16.5
The displayed data is not correct.	
Check that the ambient temperature and humidity are within the specifications.	3.2
Check that noise is not affecting the measurement.	3.1, 3.3
Check the wiring of the measurement cable.	3.3 to 3.9
Check the wiring system.	3.6 to 3.9, 5.1
Check that the line filter is turned OFF.	5.5
Check the measurement period settings.	6.2
Power cycle the instrument.	3.10
Keys do not work.	
Check the REMOTE indicator. If the REMOTE indicator is ON, press the LOCAL key to turn it OFF.	—
Do a key test. If it fails, servicing is required..	16.3
Triggering does not work.	
Check the trigger conditions.	9.3
Check that the trigger source is being applied.	9.3
Unable to make harmonic measurements.	
Check the PLL source settings.	7.4
Check that the PLL source input signal is within the specifications.	7.4
Unable to print.	
The printer head may be damaged or worn out. Servicing required.	—
Unable to recognize the medium.	
Check that the cables are properly connected.	12.3
Check the format of the medium. If necessary, format the medium.	12.5
The medium may be damaged.	—
Unable to save data to the selected medium.	
Check the format of the medium. If necessary, format the medium.	12.5
Check that the write-protect is disabled.	—
Check the free space on the medium. Remove unnecessary files as necessary or use a new medium.	12.5
Unable to set or control the instrument via the communication interface.	
Check that the GP-IB address or the parameter settings of the serial interface satisfy the specifications.	—*
Check that the interface satisfies the electrical and mechanical specifications.	—*

\* See the *Communication Interface User's Manual (IM760101-11E)*.

## 16.2 Error Messages and Corrective Actions

### Error Messages

There are cases in which error messages are displayed on the screen during operation. This section describes the meanings of the messages and the appropriate corrective actions. The messages can be displayed in English or Japanese (see section 15.6). If the corrective action indicates servicing, contact your nearest YOKOGAWA dealer for repairs.

In addition to the error messages listed in this section, there are also communication related error messages. These messages are described in the *Communication Interface User's Manual (IM760101-11E)*.

### Error in Execution

Code	Message	Corrective Action	Sections
11	Cannot measure PLL frequency.	Check input level.	7.4
601	Invalid file name or SCSI ID.	Check file name or SCSI ID.	12.4, 12.6
602	No media inserted or no SCSI device.	Make sure that the storage medium is inserted (if applicable), and check the SCSI device connection and the SCSI ID.	12.1-12.4
603	No SCSI device or no media inserted.	Check the SCSI device connection and the SCSI ID, and make sure that the storage medium is inserted (if applicable).	12.1-12.4
604	Media failure.	Check the storage medium.	—
605	File not found.	Check the file name and the storage medium.	—
606	Media is protected.	Set the disk's (medium's) write protect switch to OFF.	—
607	Media was removed while accessing.	Check the storage medium.	—
608 , 609	File already exists.	—	12.6
610	Contains invalid characters.	—	12.6
611 , 612	Media full.	Delete unnecessary file(s) or use another disk.	12.5-12.10
613	File system failure.	Check using another disk. If the same message still appears, maintenance service is required.	—
614	File is protected.	—	12.9
615	Physical format error.	Reformat the medium. If the same error occurs, the instrument is probably unable to execute a format on this medium.	12.5
616 to 620	File system failure.	Check using another disk. If the same message still appears, maintenance service is required.	—
621	File is damaged.	Check the file.	—
622 to 641	File system failure.	Check using another disk. If the same message still appears, maintenance service is required.	—
642	No media exists in SCSI device.	Check that the storage medium is correctly inserted in the SCSI device.	—
643 to 653	Media failure.	Check the medium.	—
654	Media failure.	Check the format type of the floppy disk.	12.5
655 to 664	File system failure.	Check using another disk. If the same message still appears, maintenance service is required.	—
665	Cannot load this file format. File was stored on other models or other versions.	—	—
666	File is now being accessed.	Execute after access is made.	—
668	Cannot find '.HDR' file.	Check the file.	12.6

## 16.2 Error Messages and Corrective Actions

Codes	Messages	Actions	Sections
669	Cannot find '.INF' file.	Check the file.	—
670	No wave displayed.	Turn ON the display for the appropriate waves.	9.5
671	Save data not found.	Check for presence of data.	12.6,12.7
672	This model does not have the SCSI interface.	—	page iii
673	SCSI controller failure.	Maintenance service is required.	—
674	Initializing file system.	Please wait.	12.5
675	Cannot load this file.	—	—
679	Printer error.	Maintenance service is required.	—
680	Move the release arm to the "HOLD" position.	—	14.1
681	Paper empty.	Load a roll chart.	14.1
682, 683	Printer over heat.	Power off immediately.	—
684	No built-in printer on this model.	Check the specifications to see whether or not the optional printer is provided.	page ii
685	Printer time out.	Maintenance service is required.	—
705	Can not operate while accessing medium.	Wait until access has completed.	—
706	Can not operate during hard copy.	Wait until output has completed.	—
710	File not found.	Check the file.	—
711	File operation not allowed during hard copy.	Wait until the hard copy completes.	—
712	Can not compress this hardcopy image.	Turn off compression switch.	12.7
750	Cannot connect to the ftp server.	Confirm the network settings and connection.	Chapter 13
751	Has not connect with ftp server yet.	Confirm the network settings and connection.	Chapter 13
752	This ftp function in not supported.	—	Chapter 13
753	FTP Error: Pwd	Confirm the network settings and connection.	Chapter 13
754	FTP Error: Cwd	Confirm the network settings and connection.	Chapter 13
755	FTP Error: Rm	Confirm the network settings and connection.	Chapter 13
756	FTP Error: List	Confirm the network settings and connection.	Chapter 13
757	FTP Error: Mkdir	Confirm the network settings and connection.	Chapter 13
758	FTP Error: Rmdir	Confirm the network settings and connection.	Chapter 13
759	FTP Error: Get	Confirm the network settings and connection.	Chapter 13
760	FTP Error: Put	Confirm the network settings and connection.	Chapter 13
761	FTP Error: GetData	Confirm the network settings and connection.	Chapter 13
762	FTP Error: PutData	Confirm the network settings, connection, and disk capacity.	Chapter 13
763	FTP Error: AppendData	Confirm the network settings, connection, and disk capacity.	Chapter 13
764	FTP Error: Client Handle	Confirm the network settings and connection.	Chapter 13
765	FTP Error: Others	Confirm the network settings and connection.	Chapter 13
785	Cannot send data to a network printer.	Confirm the network settings and connection.	Chapter 13
786	Cannot send a mail.	Confirm the network settings and connection.	Chapter 13

## 16.2 Error Messages and Corrective Actions

### Error in Setting

Code	Message	Corrective Action	Sections
800	Illegal date-time.	Set the correct date and time.	3.11
801	Illegal file name.	The file name contains characters which are not allowed or the file name is not a valid MS-DOS file name. Enter another file name.	12.6
802	Cannot be set in the normal measurement mode.	Set the measurement mode to harmonic.	7.1
803	Cannot be set in the harmonic measurement mode.	Set the measurement mode to normal.	7.1
805	Cannot change this parameter when averaging is ON.	Turn OFF the averaging function.	5.6
806	Cannot change this parameter when any of the user-defined functions is ON.	Turn OFF all user-defined functions.	6.4, 7,8
808	Cannot change this parameter during numerical display.	—	—
809	Cannot change this parameter during vector display.	—	—
810	Cannot change this parameter during bar graph display.	—	—
812	Cannot be set while storing/recalling of data being performed.	—	—
813	Cannot be set while integration is running.	Reset Integration.	6.11
816	Cannot set selected Harmonics Object with current Wiring Pattern.	—	5.1
820	Cannot be set while trend sampling is running.	—	10.1
823	Cannot change during CAL.	Wait until CAL is completed.	15.4
827	Illegal math expression.	Input a correct computing equation.	6.4, 7.8
834	Duplicate SCSI ID.	Set different ID numbers.	12.4
840	Attempted to start integration when wave sampling was ON.	Turn OFF the wave sampling function.	9.1
841	Attempted to start integration after integration time has reached its preset value.	Reset Integration.	6.11
842	Attempted to start integration while integration is in progress.	—	6.11
843	Measurement stopped due to overflow during integration or due to a power failure.	Reset Integration.	6.11
844	Attempted to stop integration even though integration was not in progress.	—	6.11
845	Attempted to reset integration even though integration was in progress or integration mode was not selected.	—	6.11
846	Attempted to start integration while measurement of peak overflow was in progress or during an overrange condition.	—	6.11
847	Attempted to start integration in continuous integration mode when integration preset time was set to "0".	—	6.8
848	Attempted made to start integration in real time counting integration mode when the end time had already passed.	—	6.9
849	Attempted made to start storing in real time counting storing mode when the end time had already passed.	—	11.2

## 16.2 Error Messages and Corrective Actions

Code	Message	Corrective Action	Sections
850	Stored file already exists. Initialize memory before storing.	—	11.4
851	Stored file and measurement mode are different. Set the appropriate measurement mode before recalling.	—	7.1
852	Stored file is illegal. Initialize memory before storing.	—	11.4
853	Cannot be executed/set during Recall mode. Set the Mode to Store.	—	11.1
854	Waveform display data not found.	Turn ON the wave sampling function.	9.1
855	Storing memory is full. Storing has been stopped.	—	11.4
856	An error has occurred while storing. Storing has been stopped.	—	—
857	Cannot be set while Master/Slave Synchronized Measurement is set to Slave.	—	5.10
860	Attempted to start integration while trend sampling was ON.	Turn OFF the trend sampling function.	10.1

### Error in System Operation

Code	Message	Corrective Action	Sections
901	Failed to backup setup data.	Will initialize.	3.10
902	System RAM failure.	Maintenance service is required.	—
903	System ROM failure.	Maintenance service is required.	—
904	System RAM failure.	Maintenance service is required.	—
906	Fan stopped.	Power off immediately. Maintenance service is required.	—
907	Backup battery is flat.	Maintenance service is required to replace the backup battery.	—
908	Internal temperature is too high.	Power off immediately. Maintenance service is required.	—
909	Illegal SUM value.	Maintenance service is required.	—
910	RAM read/write error.	Maintenance service is required.	—
911	Memory bus error.	Maintenance service is required.	—
912	Fatal error in Communication-driver.	Maintenance service is required.	—
914	Time out occurs in Communications.	—	—
915	EEPROM SUM error.	EEPROM may be damaged. Maintenance service is required.	—
920	SUM error of NULL value.	The Null value is reset to 0.	—
921	System Failed to Draw Display.	—	—
922	Failed in communication with DSP.	—	—
923	Transmit data abnormality from DSP.	—	—
924	FIFO abnormality.	—	—

#### Note

If the corrective action indicates maintenance service, try initializing the instrument. It may recover from the error.

## 16.3 Performing a Self-Test

### Keys

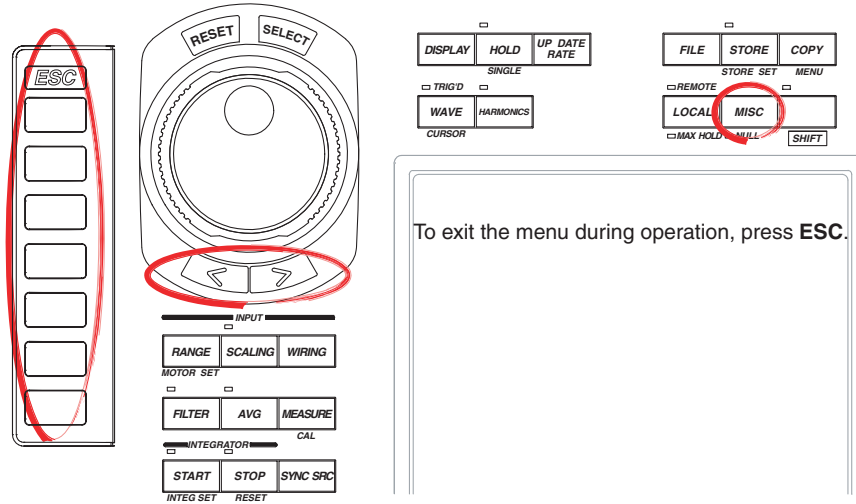

### Procedure

1. Press **MISC** to display the Misc menu.
2. Press the **Selftest** soft key to display the Selftest menu.
3. Press the **Test Item** soft key to display the Test Item menu.
4. Press the **Memory** or **Key Board** soft key to select the test item.

If you selected Memory, proceed to “Testing the Memory” on the next page.

If you selected Key Board, proceed to “Testing the Keys and the Keyboard” on the next page.

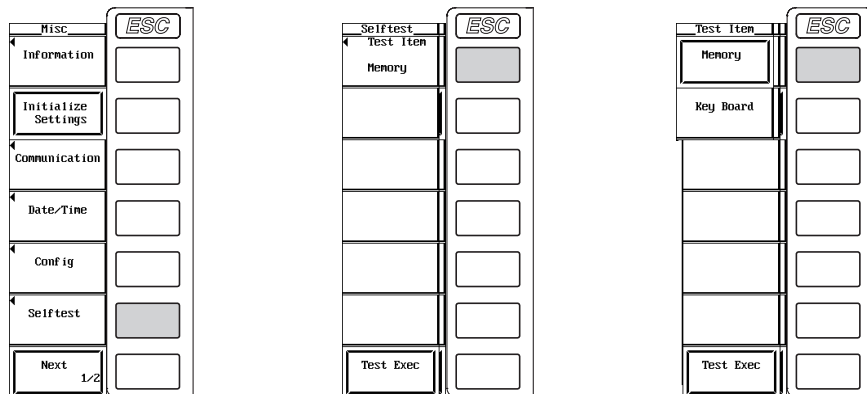



**Testing the Memory**

- Pressing the **Test Exec** soft key execute the memory test.

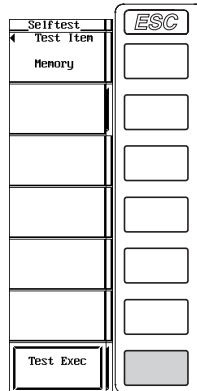

**Testing the Keys and the Keyboard**

• **Testing the Keys**

- Press the **Test Exec** soft key.
- Press the front panel **keys** to test them.
- Press the arrow keys (< and >). The indicator lights one by one each time an arrow key is pressed.
- Press **ESC** twice to exit from the key test.

• **Testing the keyboard**

- Press the **Soft Key** soft key to display the keyboard.
- Operate the **keyboard**. Check that the characters entered on the keyboard are correctly displayed in the entry box of the keyboard.

For keyboard operations, see section 3.12, "Entering Values and Strings."

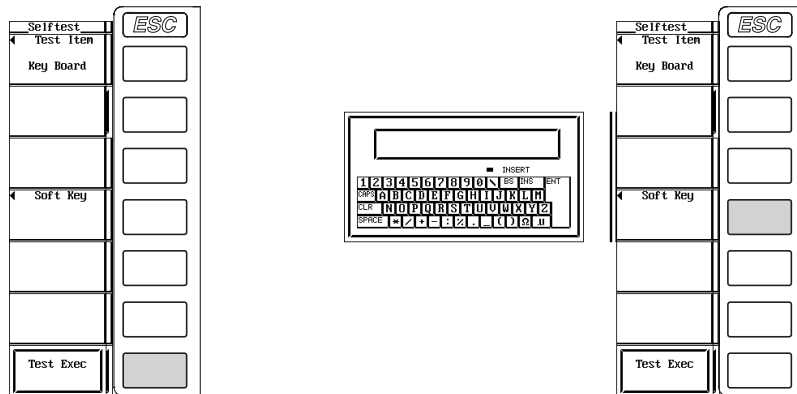

**Explanation**

**Memory Test**

Tests whether the internal ROM and RAM are operating correctly. If Pass is displayed, it is operating correctly. If Failed is displayed, contact your nearest YOKOGAWA dealer.

**Testing the Keys and the Keyboard**

- Tests whether the front panel keys are operating properly. If the name of the key being pressed appears on the screen, it is operating correctly.
- If the indicator turns ON/OFF when the arrow keys (< or >) are pressed, the keys are operating correctly.
- To exit from the key test, press ESC twice.
- If the display is not correct, contact your nearest YOKOGAWA dealer.

# 16.4 Checking the System Conditions

## Keys

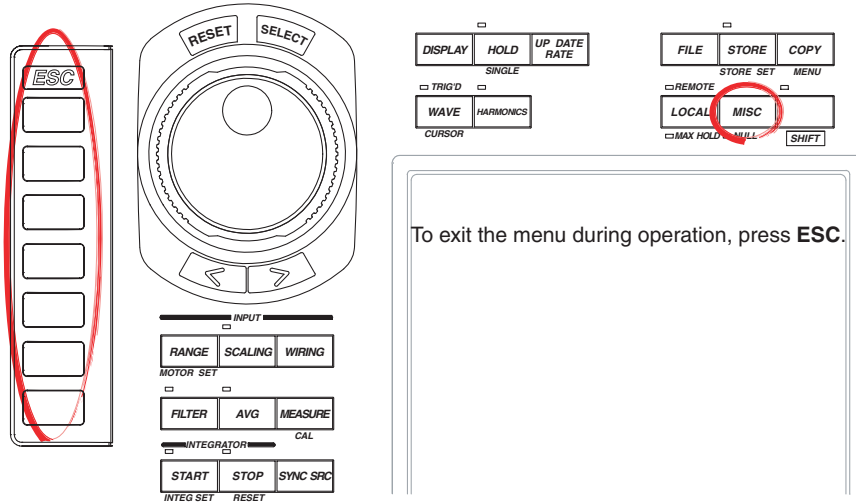

To exit the menu during operation, press **ESC**.

## Procedure

1. Press **MISC** to display the Misc menu.
2. Press the **Information** soft key to display the Information window.

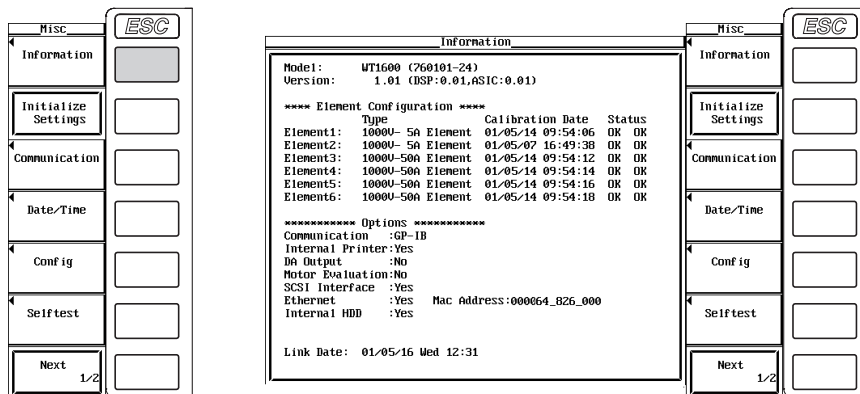

## Explanation

### Displaying the System Conditions

You can check the model, ROM version, element configuration, and the existence of options.

## 16.5 Replacing the Power Fuse



### WARNING

- To prevent the possibility of fire, use only a fuse having the specified rating (voltage, current, and type).
- Make sure to turn OFF the instrument and unplug the power cord before replacing the fuse.
- Never short the fuse holder.

### Fuse Rating

The power fuse used on this instrument is specified as follows.

- Maximum rated voltage: 250 V
- Maximum rated current: 6.3 A
- Type: Time lag
- Standard: UL/VDE certified
- Part number: A1354EF

### Replacement Procedure

Replace the power fuse according to the procedure below.

1. Turn OFF the power switch.
2. Remove the power cord from the power connector.
3. Insert the tip of a flat-blade screw driver in the dented section of the fuse holder on the power connector side, turn it in the direction of the arrow, and remove the fuse holder.
4. Remove the blown fuse that is attached to the tip of the fuse holder.
5. Attach a new fuse to the fuse holder and attach the fuse holder back in the original place.

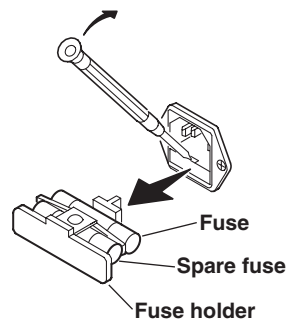

---

## 16.6 Recommended Replacement Parts

The three-year warranty applies only to the WT1600 (starting from the day of delivery) and does not cover any other items nor expendable items (items which wear out). The replacement period for expendable items varies depending on the conditions of use. Refer to the table below as a general guideline. Contact your nearest YOKOGAWA dealer for replacement parts.

<b>Parts Name</b>	<b>Recommended Replacement Period</b>
Built-in printer	Under normal usage, 200 rolls of paper (part No. : B9316FX)
LCD backlight	3 years
Backup battery (Lithium battery)	3 years

<b>Parts Name</b>	<b>Warranty Period</b>
Built-in hard disk	1 year after purchase (excludes data)

# 17.1 Input

Item	Specification
Input terminal type	Voltage Plug-in terminal (safety terminal) Current <ul style="list-style-type: none"> <li>• Direct input : Large binding post (frequency band of assured accuracy: up to 1 MHz for the 5 A terminal, up to 100 kHz for the 50 A terminal).</li> <li>• Current sensor input : BNC connector (frequency band of assured accuracy: up to 500 kHz).</li> </ul>
Input format	Voltage Floating input, resistive voltage divider Current Floating input, shunt input
Measurement range (Rated value)	Voltage <ul style="list-style-type: none"> <li>• When the crest factor is set to 3: 1.5 V, 3 V, 6 V, 10 V, 15 V, 30 V, 60 V, 100 V, 150 V, 300 V, 600 V, and 1000 V</li> <li>• When the crest factor is set to 6: 750 mV, 1.5 V, 3 V, 5 V, 7.5 V, 15 V, 30 V, 50 V, 75 V, 150 V, 300 V, and 500 V</li> </ul> Current (5-A input element) <ul style="list-style-type: none"> <li>• Direct input:               <ul style="list-style-type: none"> <li>• When the crest factor is set to 3: 10 mA, 20 mA, 50 mA, 100 mA, 200 mA, 500 mA, 1 A, 2 A, and 5 A</li> <li>• When the crest factor is set to 6: 5 mA, 10 mA, 25 mA, 50 mA, 100 mA, 250 mA, 500 mA, 1 A, and 2.5 A</li> </ul> </li> <li>• Current sensor input:               <ul style="list-style-type: none"> <li>• When the crest factor is set to 3: 50 mV, 100 mV, 250 mV, 500 mV, 1 V, 2.5 V, 5 V, and 10 V</li> <li>• When the crest factor is set to 6: 25 mV, 50 mV, 125 mV, 250 mV, 500 mV, 1 V, 2.5 V, and 5 V</li> </ul> </li> </ul> Current (50-A input element) <ul style="list-style-type: none"> <li>• Direct input:               <ul style="list-style-type: none"> <li>• When the crest factor is set to 3: 1 A, 2 A, 5 A, 10 A, 20 A, and 50 A</li> <li>• When the crest factor is set to 6: 500 mA, 1 A, 2.5 A, 5 A, 10 A, and 25 A</li> </ul> </li> <li>• Current sensor input:               <ul style="list-style-type: none"> <li>• When the crest factor is set to 3: 50 mV, 100 mV, 250 mV, 500 mV, 1 V, 2.5 V, 5 V, and 10 V</li> <li>• When the crest factor is set to 6: 25 mV, 50 mV, 125 mV, 250 mV, 500 mV, 1 V, 2.5 V, and 5 V</li> </ul> </li> </ul>
Input impedance (Input resistance)	Voltage Approx. 2 M $\Omega$ Current (5-A input element) <ul style="list-style-type: none"> <li>• Direct input: Approx. 100 m<math>\Omega</math> + approx. 0.07 <math>\mu</math>H</li> <li>• Current sensor input: Approx. 100 k<math>\Omega</math></li> </ul> Current (50-A input element) <ul style="list-style-type: none"> <li>• Direct input: Approx. 2 m<math>\Omega</math> + approx. 0.07 <math>\mu</math>H</li> <li>• Current sensor input: Approx. 100 k<math>\Omega</math></li> </ul>
Instantaneous maximum allowable input (1 period, for 20 ms)	Voltage Peak value of 4000 V or RMS value of 1500 V, whichever is less. Current (5-A input element) <ul style="list-style-type: none"> <li>• Direct input: Peak value of 30 A or RMS value of 15 A, whichever is less.</li> <li>• Current sensor input: Peak value less than or equal to 10 times the measurement range.</li> </ul> Current (50-A input element) <ul style="list-style-type: none"> <li>• Direct input: Peak value of 450 A or RMS value of 300 A, whichever is less.</li> <li>• Current sensor input: Peak value less than or equal to 10 times the measurement range.</li> </ul>
Continuous maximum allowable input	Voltage Peak value of 1500 V or RMS value of 1000 V, whichever is less. Current (5-A input element) <ul style="list-style-type: none"> <li>• Direct input: Peak value of 10 A or RMS value of 7 A, whichever is less.</li> <li>• Current sensor input: Peak value less than or equal to 5 times the measurement range.</li> </ul> Current (50-A input element) <ul style="list-style-type: none"> <li>• Direct input: Peak value of 150 A or RMS value of 50 A, whichever is less.</li> <li>• Current sensor input: Peak value less than or equal to 5 times the measurement range.</li> </ul>

## 17.1 Input

Item	Specification
Continuous maximum common mode voltage (50/60 Hz)	600 Vrms
Influence from common mode voltage	When 600 Vrms is applied with the voltage input terminals shorted and current input terminals open. <ul style="list-style-type: none"><li>• 50/60 Hz: <math>\pm 0.01\%</math> of range or less (<math>\pm(0.01 \times 15/(\text{rated value of the range}))\%</math> of range or less for 10-V range or less).</li><li>• Up to 100 kHz (reference value): <math>\pm 0.1 \times f\%</math> of range or less (<math>\pm(0.1 \times f \times 15/(\text{rated value of range}))\%</math> of range or less for 10-V range or less). Twice this value if the crest factor is set to 6. Except, at least 0.01%. The unit of frequency f is kHz.</li></ul>
Line filter	Select from OFF, 500 Hz, and 5.5 kHz.
Zero crossing filter	Select from OFF and 500 Hz.
A/D converter	Simultaneous conversion of voltage and current inputs. Resolution: 16 bits. Conversion speed: Approx. 5 $\mu\text{s}$ .
Range switching	Specifiable for each input element manually, automatically, or through communication commands.
Auto range function	Range increase <ul style="list-style-type: none"><li>• When Urms or Irms exceeds 110% of the measurement range</li><li>• When the peak value of the input signal exceeds approx. 330% (Approx. 660% if the crest factor is set to 6) of the measurement range</li></ul> Range decrease When Urms or Irms is less than or equal to 30% of the measurement range and Upk and Ipk is less than or equal to 300% (Less than or equal to 600% if the crest factor is set to 6) of the next lower range

## 17.2 Display

Item	Specification
Display	6.4" color TFT LCD monitor
Display resolution of the entire screen*	640 (H) $\times$ 480 (V) dots
Display resolution of the waveform display	501 (H) $\times$ 432 (V) dots

\* The LCD screen may contain 0.02% of defect with respect to the total number of pixels.

## 17.3 Measurement Functions (Items) during Normal Measurement

### Measurement Functions Determined for Each Input Element

For details on the determination and equations of measurement functions, see appendix 1.

Item	Symbol and Meaning
Voltage (V)	Urms: true rms value, Umn: rectified mean value calibrated to the rms value, Udc: simple average, Uac: AC component
Current (A)	Irms: true rms value, Imn: rectified mean value calibrated to the rms value, Idc: simple average, Iac: AC component
Active power (W)	P
Apparent power (VA)	S
Reactive power (var)	Q
Power factor	$\lambda$
Phase difference (°)	$\phi$
Frequency (Hz)	fU (FreqU): voltage frequency, fI (FreqI): current frequency The frequency of up to three signals can be measured as fU or fI. You can also select to measure only three sets of voltage frequencies or only three sets of current frequencies. The display of signals that are not selected shows [-----] (no data).
Voltage max. and min. (V)	U+pk: Voltage maximum, U-pk: Voltage minimum
Current max. and min. (A)	I+pk: Current maximum, I-pk: Current minimum
Crest factor	CfU: Voltage crest factor, CfI: Current crest factor
Form factor	FfU: Voltage form factor, FfI: Current form factor
Impedance ( $\Omega$ ) of the load circuit	Z
Resistance and reactance ( $\Omega$ ) of the load circuit	Rs: Resistance of the load circuit that has a resistor R, inductor L, and capacitor C connected in series Xs: Reactance of the load circuit that has a resistor R, inductor L, and capacitor C connected in series Rp: Resistance of the load circuit that has an R, L, and C connected in parallel Xp: Reactance of the load circuit that has an R, L, and C connected in parallel
Corrected Power(W) (Applicable standard IEC76-1(1976), IEEE C57.12.90-1993, IEC76-1(1993))	Pc
Integration	Time: Integration time Wp: Sum of positive and negative watt hours Wp+: Sum of positive P (consumed watt hour) Wp-: Sum of negative P (watt hour returned to the power supply) q: Sum of positive and negative ampere hours q+: Sum of positive I (ampere hour) q-: Sum of negative I (ampere hour)

However, the ampere hour is the integration of one of the selected current Irms, Imn, Idc, or Iac.

### 17.3 Measurement Functions (Items) during Normal Measurement

#### Measurement Functions ( $\Sigma$ Functions) Determined for Each Wiring Unit ( $\Sigma A$ , $\Sigma B$ , and $\Sigma C$ )

For details on the determination and equations of  $\Sigma$  functions, see appendix 1.

Item	Symbol and Meaning
Voltage (V)	Urms $\Sigma$ : true rms value, Umn $\Sigma$ : rectified mean value calibrated to the rms value, Udc $\Sigma$ : simple average, Uac $\Sigma$ : AC component
Current (A)	Irms $\Sigma$ : true rms value, Imn $\Sigma$ : rectified mean value calibrated to the rms value, Idc $\Sigma$ : simple average, Iac $\Sigma$ : AC component
Active power (W)	P $\Sigma$
Apparent power (VA)	S $\Sigma$
Reactive power (var)	Q $\Sigma$
Power factor	$\lambda$ $\Sigma$
Phase difference (°)	$\phi$ $\Sigma$
Impedance ( $\Omega$ ) of the load circuit	Z $\Sigma$
Resistance and reactance ( $\Omega$ ) of the load circuit	Rs $\Sigma$ : Resistance of the load circuit that has a resistor R, inductor L, and capacitor C connected in series Xs $\Sigma$ : Reactance of the load circuit that has a resistor R, inductor L, and capacitor C connected in series Rp $\Sigma$ : Resistance of the load circuit that has an R, L, and C connected in parallel Xp $\Sigma$ : Reactance of the load circuit that has a R, L, and C connected in parallel
Corrected Power(W) (Applicable standard IEC76-1(1976), IEEE C57.12.90-1993, IEC76-1(1993))	Pc $\Sigma$
Integration	Time: Integration time Wp $\Sigma$ : Sum of positive and negative watt hours Wp+ $\Sigma$ : Sum of positive P (consumed watt hour) Wp- $\Sigma$ : Sum of negative P (watt hour returned to the power supply) q $\Sigma$ : Sum of positive and negative ampere hours q+ $\Sigma$ : Sum of positive I (ampere hour) q- $\Sigma$ : Sum of negative I (ampere hour)
Efficiency 1	$\eta$ : Efficiency of wiring B against wiring A
Efficiency 2	1/ $\eta$ : Efficiency of wiring A against wiring B

#### Measurement Functions of Motor Evaluation

For details on the determination and equations of the measurement functions of motor evaluation, see appendix 1.

Item	Symbol and Meaning
Rotating speed	Speed: Motor's rotating speed
Torque	Torque: Motor's torque
Synchronous speed	Sync
Slip (%)	Slip
Motor output	Pm: Motor's mechanical output (mechanical power)
Motor efficiency* (%)	$\eta mA$ or $\eta mB$ : Ratio of the motor output versus the power consumption of the motor
Total efficiency* (%)	$\eta mA$ or $\eta mB$ : Ratio of the motor output versus the power consumed by the motor as well as the converter through which power is fed to the motor

\* If P $\Sigma A$  is the power to the converter and the motor and P $\Sigma B$  is the power to the motor,  $\eta mA$  and  $\eta mB$  are the total efficiency and motor efficiency, respectively. Conversely, if P $\Sigma B$  is the power to the converter and the motor and P $\Sigma A$  is the power to the motor,  $\eta mB$  and  $\eta mA$  are the total efficiency and motor efficiency, respectively. For details, see section 8.8.



# 17.4 Measurement Functions (Items) during Harmonic Measurement

## Measurement Functions Determined for Each Input Element

For details on the determination and equations of measurement functions, see appendix 1.

Item	Symbol and Meaning
Voltage (V)	U(k): rms value of the harmonic voltage of order k <sup>1</sup> , U: total rms value of the voltage signal <sup>2</sup>
Current (A)	I(k): rms value of the harmonic current of order k, I: total rms value of the current signal
Active power (W)	P(k): Active power of the harmonic signal of order k, P: total active power
Apparent power (VA)	S(k): Apparent power of the harmonic signal of order k, S: total apparent power
Reactive power (var)	Q(k): Reactive power of the harmonic signal of order k, Q: total reactive power
Power factor	λ(k): Power factor of the harmonic signal of order k, λ total power factor
Phase difference (°)	φ(k): Phase difference between the harmonic voltage and current of order k, φ total phase φ <sub>U</sub> (k): Phase difference of each harmonic voltage U(k) with respect to the fundamental signal U(1) φ <sub>I</sub> (k): Phase difference of each harmonic current I(k) with respect to the fundamental signal I(1)
Impedance (Ω) of the load circuit	Z(k): Impedance of the load circuit observed by the k <sup>th</sup> order harmonic signal.
Resistance and reactance (Ω) of the load circuit	Rs(k): Resistance observed by the k <sup>th</sup> order harmonic signal of the load circuit that has a resistor R, inductor L, and capacitor C connected in series Xs(k): Reactance observed by the k <sup>th</sup> order harmonic signal of the load circuit that has a resistor R, inductor L, and capacitor C connected in series Rp(k): Resistance observed by the k <sup>th</sup> order harmonic signal of the load circuit that has a resistor R, inductor L, and capacitor C connected in parallel Xp(k): Reactance observed by the k <sup>th</sup> order harmonic signal of the load circuit that has a resistor R, inductor L, and capacitor C connected in parallel
Harmonic distortion factor [%]	U <sub>hdf</sub> (k): The ratio of the harmonic voltage U(k) to U(1) or U expressed as a percentage. I <sub>hdf</sub> (k): The ratio of the harmonic current I(k) to I(1) or I expressed as a percentage. P <sub>hdf</sub> (k): The ratio of the active power P(k) of the harmonic signal to P(1) or P expressed as a percentage.
Total harmonic distortion [%]	U <sub>thd</sub> : The ratio of the total harmonic voltage to U(1) or U <sup>3</sup> expressed as a percentage. I <sub>thd</sub> : The ratio of the total harmonic current to I(1) or I expressed as a percentage. P <sub>thd</sub> : The ratio of the active power of the total harmonic signal to P(1) or P expressed as a percentage.
Telephone harmonic factor <sup>4</sup> (Applicable standard IEC34-1(1996))	U <sub>thf</sub> : Telephone harmonic factor of voltage, I <sub>thf</sub> : Telephone harmonic factor of current
Telephone influence factor <sup>4</sup> (Applicable standard IEC34-1(1996))	U <sub>tif</sub> : Telephone influence factor of voltage, I <sub>tif</sub> : Telephone influence factor of current
Harmonic voltage factor <sup>4</sup> (Applicable standard IEC34-1(1996))	hvf: harmonic voltage factor
Harmonic current factor <sup>4</sup> (Determined in the same way as hvf.)	hcf: harmonic current factor
Frequency (Hz)	f <sub>U</sub> (FreqU): voltage frequency, f <sub>I</sub> (FreqI): current frequency The frequency of up to three signals including the signal selected for the PLL source can be measured as f <sub>U</sub> or f <sub>I</sub> . You can also select to measure only three sets of voltage frequencies or only three sets of current frequencies. The display of signals that are not selected shows [-----] (no data).

\*1 k is an integer in the range from 0 to the upper limit of harmonic order under analysis. 0<sup>th</sup> order is the DC component. The upper limit is determined automatically (maximum is 100) by the frequency of the PLL source.

\*2 Total is a value determined according to the equation given in appendix 1 from the fundamental signal (1<sup>st</sup> order) and all harmonic components (2<sup>nd</sup> to the upper limit). The DC component can also be included.

\*3 Total harmonic is a value determined according to the equation given in appendix 1 from all harmonic components (2<sup>nd</sup> to the upper limit).

\*4 Measurement functions specific to the IEC or IEEE standard. For details, see appendix 1.

## 17.4 Measurement Functions (Items) during Harmonic Measurement

### Measurement functions indicating the phase difference of the fundamental voltage and current between elements

These measurement functions express the phase difference of fundamental wave  $U(1)$  and  $I(1)$  of other elements with respect to the fundamental wave  $U(1)$  of the element with the smallest number of the input elements that are assigned to the wiring unit. The following table indicates the measurement functions for a wiring unit that combines elements 1, 2, and 3.

Item	Symbol and Meaning
Phase difference U1-U2 (°)	$\phi_{U1-U2}$ : Phase difference of the fundamental voltage ( $U2(1)$ ) of element 2 with respect to the fundamental voltage ( $U1(1)$ ) of element 1.
Phase difference U1-U3 (°)	$\phi_{U1-U3}$ : Phase difference of the fundamental voltage ( $U3(1)$ ) of element 3 with respect to $U1(1)$ .
Phase difference U1-I1 (°)	$\phi_{U1-I1}$ : Phase difference of the fundamental current ( $I1(1)$ ) of element 1 with respect to $U1(1)$ .
Phase difference U1-I2 (°)	$\phi_{U1-I2}$ : Phase difference of the fundamental current ( $I2(1)$ ) of element 2 with respect to $U1(1)$ .
Phase difference U1-I3 (°)	$\phi_{U1-I3}$ : Phase difference of the fundamental current ( $I3(1)$ ) of element 3 with respect to $U1(1)$ .

### Measurement Functions ( $\Sigma$ Functions) Determined for Each Wiring Unit ( $\Sigma A$ , $\Sigma B$ , and $\Sigma C$ )

For details on the determination and equations of  $\Sigma$  functions, see appendix 1.

Item	Symbol and Meaning
Voltage (V)	$U_{\Sigma}(1)$ : rms value of the harmonic voltage of order 1 <sup>*1</sup> , $U_{\Sigma}$ : total rms value of the voltage signal <sup>*2</sup>
Current (A)	$I_{\Sigma}(1)$ : rms value of the harmonic current of order 1, $I_{\Sigma}$ : total rms value of the current signal
Active power (W)	$P_{\Sigma}(1)$ : Active power of the harmonic signal of order 1, $P_{\Sigma}$ : total active power
Apparent power (VA)	$S_{\Sigma}(1)$ : Apparent power of the harmonic signal of order 1, $S_{\Sigma}$ : total apparent power
Reactive power (var)	$Q_{\Sigma}(1)$ : Reactive power of the harmonic signal of order 1, $Q_{\Sigma}$ : total reactive power
Power factor	$\lambda_{\Sigma}(1)$ : Power factor of the harmonic signal of order 1, $\lambda_{\Sigma}$ total power factor

\*1 Total is a value determined according to the equation given in appendix 1 from the fundamental signal (1<sup>st</sup> order) and all harmonic components (2<sup>nd</sup> to the upper limit). The DC component can also be included.

# 17.5 Accuracy

## Voltage and Current Accuracy

Item	Specification	
Accuracy (3-month accuracy)	Conditions Temperature: 23±3° C. Humidity: 30 to 75%RH. Input waveform: Sine wave. Common-mode voltage: 0 V. Line filter: OFF. λ(power factor): 1. Crest factor: 3. After warm-up time has passed. Wired condition after zero-level compensation or measurement range change. f is the frequency.	
	Frequency	Accuracy ±(reading error + measurement range error)
	DC	0.1% of reading + 0.2% of range
	0.5 Hz ≤ f < 10 Hz	0.1% of reading + 0.2% of range
	10 Hz ≤ f < 45 Hz	0.1% of reading + 0.1% of range
	45 Hz ≤ f ≤ 66 Hz	0.1% of reading + 0.05% of range
	66 Hz < f ≤ 1 kHz	Voltage, current of a 5-A input element from direct input or current sensor input 0.1% of reading + 0.1% of range Current of a 50-A input element from direct input 0.2% of reading + 0.1% of range
	1 kHz < f ≤ 50 kHz	Voltage, current of a 5-A input element from direct input 0.3% of reading + 0.1% of range Current sensor input (0.015 × f + 0.3)% of reading + 0.1% of range Direct input using current from a 50-A input element (0.1 × f + 0.2)% of reading + 0.1% of range
	50 kHz < f ≤ 100 kHz	Voltage, current of a 5-A input element from direct input and external input 0.6% of reading + 0.2% of range Current sensor input (0.009 × f + 0.6)% of reading + 0.2% of range Current of a 50-A input element from direct input (0.1 × f + 0.2)% of reading + 0.2% of range
	100 kHz < f ≤ 500 kHz	Voltage, current of a 5-A input element from direct input 0.006 × f% of reading + 0.5% of range Current sensor input (0.03 × f - 1.5)% of reading + 0.5% of range
	500 kHz < f ≤ 1 MHz	Voltage, current of a 5-A input element from direct input (0.022 × f - 8)% of reading + 1% of range

\* The unit of f in the reading error equation is kHz.

- Add 20% of range to the above accuracy figure for the accuracy of the waveform display data, Upk, and Ipk in the range up to 1 MHz. The effective input range is within ±300% of the range (within ±600% of the range if the crest factor is set to 6). However, for 1000 V range, the range is within ±200% (within ±400% for 500 V range if the crest factor is set to 6).
- For a 5-A input element, add 20 μA to the DC accuracy of the current.
- For a 50-A input element, add 1 mA to the DC accuracy of the current.
- For current sensor input, add 0.05/(current sensor trans. ratio) A to the DC accuracy of the current.
- For temperature changes after zero-level compensation and range change on a 5-A input element, add 10 μA/°C to the DC accuracy of the current.
- For temperature changes after zero-level compensation and range change on a 50-A input element, add 1 mA/°C to the DC accuracy of the current.
- For temperature changes after zero-level compensation and range change on a current sensor input, add {0.05/(current sensor transformation ratio)} A/°C to the DC accuracy of the current.
- For a 5-A input element, add 0.006 × I<sup>2</sup> to the current accuracy.
- For a 50-A input element, add 0.00006 × I<sup>2</sup> to the current accuracy.
- For Irms, Imean, and Iac on a 5-A input element, accuracy figures are specified with the line filter turned ON for 2 mA or less.
- For Irms, Imean, and Iac on a 50-A input element, accuracy figures are specified with the line filter turned ON for 200 mA or less.
- For Irms, Imean, and Iac on a current sensor input, accuracy figures are specified with the line filter turned ON for 10/(current sensor transformation ratio) A or less.
- When the data update rate is 50 ms, add 0.1% of range to all accuracy figures.
- All accuracy figures for 0.5 to 10 Hz are reference values.
- If f (Hz) × voltage (V) > 2.2 × 10<sup>7</sup> for frequencies above 100 kHz, the voltage accuracy figures are reference values.
- For currents that exceed 20 AAC (excluding the range of 50 to 400 Hz), the current accuracy figures are reference values.
- For currents less than 5 mA with frequencies above 1 kHz, the current accuracy figures are reference values.

## 17.5 Accuracy

Item	Specification																
Effective input range	0 to $\pm 110\%$ of the measurement range for Udc and Idc. 1 to 110% of the measurement range for Urms, Uac, Irms, and Iac. 10 to $\pm 110\%$ of the measurement range for Umn and Imn.																
Lower limit of measurement frequency	<table border="1"> <thead> <tr> <th>Data update rate</th> <th>50 ms</th> <th>100 ms</th> <th>200 ms</th> <th>500 ms</th> <th>1 s</th> <th>2 s</th> <th>5 s</th> </tr> </thead> <tbody> <tr> <td>Lower limit of measurement frequency</td> <td>45 Hz</td> <td>25 Hz</td> <td>15 Hz</td> <td>5 Hz</td> <td>2.5 Hz</td> <td>1.5 Hz</td> <td>0.5 Hz</td> </tr> </tbody> </table>	Data update rate	50 ms	100 ms	200 ms	500 ms	1 s	2 s	5 s	Lower limit of measurement frequency	45 Hz	25 Hz	15 Hz	5 Hz	2.5 Hz	1.5 Hz	0.5 Hz
Data update rate	50 ms	100 ms	200 ms	500 ms	1 s	2 s	5 s										
Lower limit of measurement frequency	45 Hz	25 Hz	15 Hz	5 Hz	2.5 Hz	1.5 Hz	0.5 Hz										
Line filter influence	When the cut-off frequency is 500 Hz 45 to 66 Hz: Add 0.2% of reading. Less than 45 Hz: Add 0.5% of reading. When the cut-off frequency is 5.5 kHz Less than 66 Hz: Add 0.2% of reading. 66 to 500 Hz: Add 0.5% of reading.																
Conditions for detecting lead and lag	Lead and lag are detected correctly when the voltage and current signals are both sine waves, the amplitude is greater than or equal to 50% (greater than or equal to 100% if the crest factor is set to 6) of the measurement range, the frequency is between 20 Hz to 10 kHz, and the phase difference is greater than or equal to $\pm 5^\circ$ .																
Temperature coefficient	Add $\pm 0.03\%$ of reading/ $^\circ$ C in the range 5 to 20 $^\circ$ C or 26 to 40 $^\circ$ C.																
One year accuracy	$\pm$ (reading error of the 3-month accuracy $\times$ 1.5).																
Accuracy when the crest factor is set to 6	Accuracy obtained by doubling the measurement range error for the accuracy when the crest factor is set to 3																

## Power Accuracy

Item	Specification																				
Accuracy (3-months accuracy)	Conditions Same as the conditions for voltage and current.																				
	<table border="1"> <thead> <tr> <th>Frequency</th> <th>Accuracy <math>\pm</math>(reading error + measurement range error)</th> </tr> </thead> <tbody> <tr> <td>DC</td> <td>0.1% of reading + 0.2% of range</td> </tr> <tr> <td>0.5 Hz <math>\leq</math> f &lt; 10 Hz</td> <td>0.2% of reading + 0.3% of range</td> </tr> <tr> <td>10 Hz <math>\leq</math> f &lt; 45 Hz</td> <td>0.1% of reading + 0.2% of range</td> </tr> <tr> <td>45 Hz <math>\leq</math> f <math>\leq</math> 66 Hz</td> <td>0.1% of reading + 0.05% of range</td> </tr> <tr> <td>66 Hz &lt; f <math>\leq</math> 1 kHz</td> <td>0.2% of reading + 0.1% of range</td> </tr> <tr> <td>1 kHz &lt; f <math>\leq</math> 50 kHz</td> <td>5-A input element and the current is direct input 0.3% of reading + 0.2% of range Current sensor input (0.02 <math>\times</math> f + 0.3)% of reading + 0.2% of range 50-A input element and the current is direct input (0.1 <math>\times</math> f + 0.2)% of reading + 0.2% of range</td> </tr> <tr> <td>50 kHz &lt; f <math>\leq</math> 100 kHz</td> <td>5-A input element and the current is direct input 0.7% of reading + 0.3% of range Current sensor input (0.009 <math>\times</math> f + 0.9)% of reading + 0.3% of range 50-A input element and the current is direct input (0.3 <math>\times</math> f - 9.5)% of reading + 0.3% of range</td> </tr> <tr> <td>100 kHz &lt; f <math>\leq</math> 500 kHz</td> <td>5-A input element and the current is direct input 0.008 <math>\times</math> f% of reading + 1% of range Current sensor input (0.06 <math>\times</math> f - 4)% of reading + 1% of range</td> </tr> <tr> <td>500 kHz &lt; f <math>\leq</math> 1 MHz</td> <td>5-A input element and the current is direct input (0.048 <math>\times</math> f - 20)% of reading + 2% of range</td> </tr> </tbody> </table> <p>* The unit of f in the read error equation is kHz.</p> <ul style="list-style-type: none"> <li>• For a 5-A input element, add 20 <math>\mu</math> A <math>\times</math> (voltage reading) to the DC accuracy.</li> <li>• For a 50-A input element, add 1 mA <math>\times</math> (voltage reading) to the DC accuracy.</li> <li>• For a current sensor input, add {0.05/(current sensor transformation ratio) A} <math>\times</math> (voltage reading) to the DC accuracy.</li> </ul>	Frequency	Accuracy $\pm$ (reading error + measurement range error)	DC	0.1% of reading + 0.2% of range	0.5 Hz $\leq$ f < 10 Hz	0.2% of reading + 0.3% of range	10 Hz $\leq$ f < 45 Hz	0.1% of reading + 0.2% of range	45 Hz $\leq$ f $\leq$ 66 Hz	0.1% of reading + 0.05% of range	66 Hz < f $\leq$ 1 kHz	0.2% of reading + 0.1% of range	1 kHz < f $\leq$ 50 kHz	5-A input element and the current is direct input 0.3% of reading + 0.2% of range Current sensor input (0.02 $\times$ f + 0.3)% of reading + 0.2% of range 50-A input element and the current is direct input (0.1 $\times$ f + 0.2)% of reading + 0.2% of range	50 kHz < f $\leq$ 100 kHz	5-A input element and the current is direct input 0.7% of reading + 0.3% of range Current sensor input (0.009 $\times$ f + 0.9)% of reading + 0.3% of range 50-A input element and the current is direct input (0.3 $\times$ f - 9.5)% of reading + 0.3% of range	100 kHz < f $\leq$ 500 kHz	5-A input element and the current is direct input 0.008 $\times$ f% of reading + 1% of range Current sensor input (0.06 $\times$ f - 4)% of reading + 1% of range	500 kHz < f $\leq$ 1 MHz	5-A input element and the current is direct input (0.048 $\times$ f - 20)% of reading + 2% of range
Frequency	Accuracy $\pm$ (reading error + measurement range error)																				
DC	0.1% of reading + 0.2% of range																				
0.5 Hz $\leq$ f < 10 Hz	0.2% of reading + 0.3% of range																				
10 Hz $\leq$ f < 45 Hz	0.1% of reading + 0.2% of range																				
45 Hz $\leq$ f $\leq$ 66 Hz	0.1% of reading + 0.05% of range																				
66 Hz < f $\leq$ 1 kHz	0.2% of reading + 0.1% of range																				
1 kHz < f $\leq$ 50 kHz	5-A input element and the current is direct input 0.3% of reading + 0.2% of range Current sensor input (0.02 $\times$ f + 0.3)% of reading + 0.2% of range 50-A input element and the current is direct input (0.1 $\times$ f + 0.2)% of reading + 0.2% of range																				
50 kHz < f $\leq$ 100 kHz	5-A input element and the current is direct input 0.7% of reading + 0.3% of range Current sensor input (0.009 $\times$ f + 0.9)% of reading + 0.3% of range 50-A input element and the current is direct input (0.3 $\times$ f - 9.5)% of reading + 0.3% of range																				
100 kHz < f $\leq$ 500 kHz	5-A input element and the current is direct input 0.008 $\times$ f% of reading + 1% of range Current sensor input (0.06 $\times$ f - 4)% of reading + 1% of range																				
500 kHz < f $\leq$ 1 MHz	5-A input element and the current is direct input (0.048 $\times$ f - 20)% of reading + 2% of range																				

Item	Specification
	<ul style="list-style-type: none"> <li>For temperature changes after zero-level compensation and range change on a 5-A input element, add <math>(10 \mu\text{A}) \times (\text{voltage reading})/^\circ\text{C}</math> to the DC accuracy.</li> <li>For temperature changes after zero-level compensation and range change on a 50-A input element, add <math>(1 \text{ mA}) \times (\text{voltage reading})/^\circ\text{C}</math> to the DC accuracy.</li> <li>For temperature changes after zero-level compensation and range change on a current sensor input, add <math>\{0.05/(\text{current sensor transformation ratio}) \text{ A}\} \times (\text{voltage reading})/^\circ\text{C}</math> to the DC accuracy.</li> <li>When the data update rate is 50 ms, add 0.1% of range to all accuracy figures.</li> <li>All accuracy figures for 0.5 to 10 Hz are reference values.</li> <li>If <math>f \text{ (Hz)} \times \text{voltage (V)} &gt; 2.2 \times 10^7</math> for frequencies above 100 kHz, the accuracy figures are reference values.</li> <li>For currents that exceed 20 AAC (excluding the range of 50 to 400 Hz), the accuracy figures are reference values.</li> <li>For currents less than 5 mA with frequencies above 1 kHz, the accuracy figures are reference values.</li> </ul>
Effective input range	<ul style="list-style-type: none"> <li>0 to <math>\pm 110\%</math> of the power range (see section 5.2) for DC measurement.</li> <li><math>\pm 110\%</math> of the power range for current measurement when the voltage and current are in the range of 1 to 110% of the measurement range. Except, the signal level of the synchronization source must be greater than or equal to 10% (greater than or equal to 20% if the crest factor is set to 6) of the measurement range.</li> </ul> <p>However, at a voltage of 1000 V, the range is up to 5 A, 50 A, and 10 V for a 5-A input element, 50-A input element, and current sensor input, respectively.</p>
Lower limit of measurement frequency	Same as the accuracy for voltage and current.
Power factor ( $\lambda$ ) influence	<ul style="list-style-type: none"> <li>When <math>\lambda = 0</math> <ul style="list-style-type: none"> <li>Add apparent power reading <math>\times 0.15\%</math> in the range of 45 to 66 Hz.</li> <li>For other frequencies, see below. However, the figures are reference values. <ul style="list-style-type: none"> <li>For a 5-A input element when the current is direct input, add the apparent power reading <math>\times (0.15 + 0.05 \times f \text{ (kHz)})\%</math>.</li> <li>For a 50-A input element when the current is direct input, add the apparent power reading <math>\times (0.15 + 0.3 \times f \text{ (kHz)})\%</math>.</li> <li>For a current sensor input, add the apparent power reading <math>\times (0.15 + 0.1 \times f \text{ (kHz)})\%</math>.</li> </ul> </li> </ul> </li> <li>When <math>0 &lt; \lambda &lt; 1</math> <ul style="list-style-type: none"> <li>Add the power reading <math>\times \{\tan\phi \times (\text{influence when } \lambda = 0)\}\%</math>. <math>\phi</math> is the phase difference between the voltage and current.</li> </ul> </li> </ul>
Line filter influence	<p>When the cut-off frequency is 500 Hz 45 to 66 Hz: Add 0.3% of reading. Less than 45 Hz: Add 1% of reading.</p> <p>When the cut-off frequency is 5.5 kHz Less than 66 Hz: Add 0.3% of reading. 66 to 500 Hz: Add 1% of reading.</p>
Temperature coefficient	Same as the temperature coefficient for voltage and current.
One year accuracy	$\pm(\text{reading error of the 3-month accuracy} \times 1.5)$ .
Accuracy when the crest factor is set to 6	Accuracy obtained by doubling the measurement range error for the accuracy when the crest factor is set to 3

### Accuracy of Other Parameters and Computation Accuracy

- For the accuracy of frequency  $f_U$  and  $f_I$ , see "Frequency Measurement" in section 17.6, "Functions."
- For the accuracy of measured values  $W_p$ ,  $W_{p+}$ ,  $W_{p-}$ ,  $q$ ,  $q_+$ , and  $q_-$  and the integration time, see "Integration" in section 17.6, "Functions."
- For the accuracy of voltage, current and power during harmonic measurement, see "Harmonic Measurement" in section 17.6, "Functions."
- For the accuracy of the rotating speed and torque, see "Motor Evaluation (Option)" in section 17.6, "Functions."
- For the D/A output accuracy, see "D/A Output (Option)" in section 17.6, "Functions."
- The computation accuracy of apparent power  $S$  and reactive power  $Q$  that can be determined from the measured value is  $\pm 0.001\%$  of the power range.
- The computation accuracy of power factor  $\lambda$  that can be determined from the measured value is  $\pm 0.0001$ .
- The computation accuracy of phase difference  $\phi$  that can be determined from the power factor is  $\pm 0.005$ .

# 17.6 Functions

## Measurement Function and Measurement Conditions

Item	Specification																		
Method	Digital multiplier method																		
Crest factor	Select 3 or 6 (when rated value of the measurement range is input) However, the actual crest factor is 2 for the 1000 V range if the crest factor is set to 3. The actual crest factor is 4 for the 500 V range if the crest factor is set to 6.																		
Measurement period	Period used to determine and compute the measurement function. <ul style="list-style-type: none"> <li>During normal measurement Measurement period is set using the zero crossing points of the reference signal (synchronization source).</li> <li>During harmonic measurement Measurement period is equal to the selected FFT data length.</li> </ul>																		
Wiring system	Select the wiring system from the following five types. 1P2W (single-phase, two-wire), 1P3W (single-phase, three-wire), 3P3W (three-phase, three-wire), 3P4W (three-phase, four-wire), and 3V3A (three-voltage, three-current) However, the selectable wiring systems vary depending on the number of input elements that are installed. You may be able to select only a single type of wiring system or two or three types of wiring systems.																		
Measurement range	See section 17.1.																		
Scaling	Set the current sensor transformation ratio, PT ratio, CT ratio, and power factor in the range of 0.0001 to 99999.9999 when inputting the external current sensor, PT, or CT output to the instrument.																		
Input filter	Specify a line filter or a zero crossing filter. See section 17.1.																		
Averaging	<ul style="list-style-type: none"> <li>During normal measurement Select exponential average or moving average. <ul style="list-style-type: none"> <li>Exponential average Select the attenuation constant from 2, 4, 8, 16, 32, and 64.</li> <li>Moving average Select the average count from 8, 16, 32, 64, 128, and 256.</li> </ul> </li> <li>During harmonic measurement Exponential average only.</li> </ul> <table border="1" style="margin-left: 20px;"> <thead> <tr> <th>FFT data length</th> <th>Fundamental frequency of the PLL source</th> <th>Attenuation constant</th> </tr> </thead> <tbody> <tr> <td rowspan="2">8192</td> <td>55 Hz ≤ f &lt; 75 Hz</td> <td>5.625</td> </tr> <tr> <td>Outside the above range</td> <td>4.6875</td> </tr> <tr> <td rowspan="2">4096</td> <td>55 Hz ≤ f &lt; 75 Hz</td> <td>11.25</td> </tr> <tr> <td>Outside the above range</td> <td>9.375</td> </tr> <tr> <td rowspan="2">2048</td> <td>55 Hz ≤ f &lt; 75 Hz</td> <td>22.5</td> </tr> <tr> <td>Outside the above range</td> <td>18.75</td> </tr> </tbody> </table>	FFT data length	Fundamental frequency of the PLL source	Attenuation constant	8192	55 Hz ≤ f < 75 Hz	5.625	Outside the above range	4.6875	4096	55 Hz ≤ f < 75 Hz	11.25	Outside the above range	9.375	2048	55 Hz ≤ f < 75 Hz	22.5	Outside the above range	18.75
FFT data length	Fundamental frequency of the PLL source	Attenuation constant																	
8192	55 Hz ≤ f < 75 Hz	5.625																	
	Outside the above range	4.6875																	
4096	55 Hz ≤ f < 75 Hz	11.25																	
	Outside the above range	9.375																	
2048	55 Hz ≤ f < 75 Hz	22.5																	
	Outside the above range	18.75																	
Data update rate	Select from 50 ms, 100 ms, 200 ms, 500 ms, 1 s, 2 s, and 5 s. However, the data update rate is slower than the specified value when the waveform data acquisition is ON or depending on the acquisition conditions of the waveform data. The display update rate is 200 ms when the data update rate is 50, ms, 100 ms, and 200 ms.																		
Response time	Data update rate × 2 at the maximum. However, when retrieval of waveform display data is OFF.																		
Hold	Holds the data display.																		
Single measurement	Executes one measurement during the held condition.																		
MAX hold	Holds the maximum value of the numerical data.																		
Zero-level compensation/Null	Performs zero-level compensation.																		

## 17.6 Functions

### Frequency Measurement

Item	Specification																
Measured item	Select up to three of the frequencies of the voltage or current that is input to the input element. During harmonic measurement, select up to three including the signal selected as the PLL source.																
Method	Reciprocal method																
Measurement range	<table border="1"> <thead> <tr> <th>Data Update Rate</th> <th>Measurement Range*</th> </tr> </thead> <tbody> <tr> <td>50 ms</td> <td>45 Hz ≤ f ≤ 1 MHz</td> </tr> <tr> <td>100 ms</td> <td>25 Hz ≤ f ≤ 1 MHz</td> </tr> <tr> <td>200 ms</td> <td>15 Hz ≤ f ≤ 500 kHz</td> </tr> <tr> <td>500 ms</td> <td>5 Hz ≤ f ≤ 200 kHz</td> </tr> <tr> <td>1 s</td> <td>2.5 Hz ≤ f ≤ 100 kHz</td> </tr> <tr> <td>2 s</td> <td>1.5 Hz ≤ f ≤ 50 kHz</td> </tr> <tr> <td>5 s</td> <td>0.5 Hz ≤ f ≤ 20 kHz</td> </tr> </tbody> </table> <p>* However, the measurement range is up to 100 kHz for a 50-A input element and 500 kHz for a current sensor input.</p>	Data Update Rate	Measurement Range*	50 ms	45 Hz ≤ f ≤ 1 MHz	100 ms	25 Hz ≤ f ≤ 1 MHz	200 ms	15 Hz ≤ f ≤ 500 kHz	500 ms	5 Hz ≤ f ≤ 200 kHz	1 s	2.5 Hz ≤ f ≤ 100 kHz	2 s	1.5 Hz ≤ f ≤ 50 kHz	5 s	0.5 Hz ≤ f ≤ 20 kHz
Data Update Rate	Measurement Range*																
50 ms	45 Hz ≤ f ≤ 1 MHz																
100 ms	25 Hz ≤ f ≤ 1 MHz																
200 ms	15 Hz ≤ f ≤ 500 kHz																
500 ms	5 Hz ≤ f ≤ 200 kHz																
1 s	2.5 Hz ≤ f ≤ 100 kHz																
2 s	1.5 Hz ≤ f ≤ 50 kHz																
5 s	0.5 Hz ≤ f ≤ 20 kHz																
Accuracy	±(0.05% of reading + 1 digit) When the input signal level is greater than or equal to 0.6 V (voltage input), 25 mV (current sensor input), 5 mA (5-A input element), or 150 mA (50-A input element) and the signal is greater than or equal to 30% (0.5 Hz to 440 Hz, with zero crossing filter ON), 10% (440 Hz to 500 kHz), or 30% (500 kHz to 1 MHz) of the measurement range. Twice these values for the input signal level when the crest factor is set to 6																
Frequency measurement filter	Zero crossing filter (see section 17.1)																

### Integration

Item	Specification
Mode	Select from manual, normal, repetitive, real-time normal, and real-time repetitive.
Measurement function	See section 17.3.
Individual element integration	All element simultaneous or individual element integration is possible. However, the individual element integration can be executed only through communication commands.
Integration timer	Automatic stop of integration by setting a timer. 0000h00m00s to 10000h00m00s
Count overflow	When the integration time reaches its maximum (10000 hours) or the integration value reaches its maximum or minimum (±999999 MWh or ±999999 MAh), the integration is stopped and the integration time and integration value at that point are held.
Accuracy	±(Power accuracy (or current accuracy) + 0.05% of reading)
Timer accuracy	±0.02%

\* Integration cannot be executed when waveform data acquisition is ON or during harmonic measurement.

## 17.6 Functions

### Harmonic Measurement

Item	Specification
Measured item	Select a single wiring unit.
Method	PLL synchronization method or external sampling clock method
Frequency range	<ul style="list-style-type: none"> <li>PLL synchronization method Fundamental frequency of the PLL source is in the range of 10 Hz to 1 kHz.</li> <li>External sampling clock method Input a sampling clock signal having a frequency that is 2048 times the fundamental frequency between 0.5 Hz and 100 Hz of the waveform on which to perform harmonic measurement. The input level is TTL. The input waveform is a rectangular wave with a duty ratio of 50%.</li> </ul>
PLL source	Select the voltage, current, or external clock of each input element.
Measurement function	See section 17.4.
FFT data length	Select from 8192, 4096, and 2048.
FFT processing word length	32 bits
Window function	Rectangular
Anti-aliasing Filter	Set using a line filter (5.5 kHz).

Sample rate (sampling frequency), window width, and upper limit of harmonic order under analysis during PLL synchronization

Fundamental Freq. of the PLL Source (Hz)	Sample Rate (S/s)	Window Width against the FFT Data Length (Freq. of the Fundamental Wave)			Upper Limit of Harmonic Order under Analysis
		8192	4096	2048	
$10 \leq f < 20$	$f \times 2048$	4	2	1	100
$20 \leq f < 40$	$f \times 1024$	8	4	2	100
$40 \leq f < 75$	$f \times 512$	16	8	4	100
$75 \leq f < 150$	$f \times 256$	32	16	8	100
$150 \leq f < 440$	$f \times 128$	64	32	16	50
$440 \leq f \leq 1000$	$f \times 64$	128	64	32	25

Sample rate, window width, and upper limit of harmonic order under analysis when using external sampling clock

Fundamental Freq. of the PLL Source (Hz)	Sample Rate (S/s)	Window Width against the FFT Data Length (Freq. of the Fundamental Wave)			Upper Limit of Harmonic Order under Analysis
		8192	4096	2048	
$0.5 \leq f \leq 100$	$f \times 2048$	4	2	1	100

However, it is  $1 \leq f \leq 100$  when the FFT data length is 8192.

Accuracy

- When line filter (5.5 kHz) is ON

Frequency	Voltage and Current $\pm(\text{reading error} + \text{measurement range error})$	Power $\pm(\text{reading error} + \text{measurement range error})$
$0.5 \text{ Hz} \leq f < 10 \text{ Hz}$	0.4% of reading + 0.2% of range	0.7% of reading + 0.3% of range
$10 \text{ Hz} \leq f < 45 \text{ Hz}$	0.4% of reading + 0.1% of range	0.6% of reading + 0.2% of range
$45 \text{ Hz} \leq f \leq 66 \text{ Hz}$	0.3% of reading + 0.05% of range	0.4% of reading + 0.05% of range
$66 \text{ Hz} < f \leq 1 \text{ kHz}$	1% of reading + 0.1% of range	1.5% of reading + 0.1% of range
$1 \text{ kHz} < f \leq 2.5 \text{ kHz}$	2% of reading + 0.1% of range	—

However, for  $n^{\text{th}}$  order component input, add  $\{n/(m+1)\}50\%$  of the  $n^{\text{th}}$  order reading to  $n+m^{\text{th}}$  order and  $n-m^{\text{th}}$  order. Accuracy obtained by doubling the measurement range error if the crest factor is set to 6.

- When line filter is OFF  
Add the following value to the accuracy during normal measurement.
  - For  $n^{\text{th}}$  order component input, add  $\{n/(m+1)\}50\%$  of the  $n^{\text{th}}$  order reading to  $n+m^{\text{th}}$  order and  $n-m^{\text{th}}$  order.
  - For  $n^{\text{th}}$  order component input, add  $(n/500)\%$  of the  $n^{\text{th}}$  order reading to the  $n^{\text{th}}$  order component.



## Motor Evaluation (Option)

Item	Specification																																				
Measurement function	See section 17.3.																																				
Revolution signal	<ul style="list-style-type: none"> <li>When the revolution signal is DC voltage (analog input) <table border="1"> <thead> <tr> <th>Item</th> <th>Specification</th> </tr> </thead> <tbody> <tr> <td>Connector type</td> <td>BNC connector</td> </tr> <tr> <td>Input range</td> <td>1 V, 2 V, 5 V, 10 V, and 20 V</td> </tr> <tr> <td>Effective input range</td> <td>±110% of the measurement range However, ±20 V or less</td> </tr> <tr> <td>Input resistance</td> <td>Approx. 1 MΩ</td> </tr> <tr> <td>Maximum allowable input</td> <td>±20 V</td> </tr> <tr> <td>Continuous maximum common mode voltage</td> <td>±42 V<sub>peak</sub> or less</td> </tr> <tr> <td>Accuracy</td> <td>±(0.1% of reading + 0.2% of range)</td> </tr> <tr> <td>Temperature coefficient</td> <td>±0.03% of range/°C</td> </tr> </tbody> </table> </li> <li>For pulse input <table border="1"> <thead> <tr> <th>Item</th> <th>Specification</th> </tr> </thead> <tbody> <tr> <td>Connector type</td> <td>BNC connector</td> </tr> <tr> <td>Frequency range</td> <td>2 Hz to 200 kHz</td> </tr> <tr> <td>Amplitude input range</td> <td>±5 V<sub>peak</sub></td> </tr> <tr> <td>Effective amplitude</td> <td>1 V (peak-to-peak) or more</td> </tr> <tr> <td>Input waveform</td> <td>50% duty ratio rectangular wave</td> </tr> <tr> <td>Input resistance</td> <td>Approx. 1 MΩ</td> </tr> <tr> <td>Continuous maximum common mode voltage</td> <td>±42 V<sub>peak</sub> or less</td> </tr> <tr> <td>Accuracy</td> <td>±(0.05% of reading + 1 mHz + 1 digit)</td> </tr> </tbody> </table> </li> </ul>	Item	Specification	Connector type	BNC connector	Input range	1 V, 2 V, 5 V, 10 V, and 20 V	Effective input range	±110% of the measurement range However, ±20 V or less	Input resistance	Approx. 1 MΩ	Maximum allowable input	±20 V	Continuous maximum common mode voltage	±42 V <sub>peak</sub> or less	Accuracy	±(0.1% of reading + 0.2% of range)	Temperature coefficient	±0.03% of range/°C	Item	Specification	Connector type	BNC connector	Frequency range	2 Hz to 200 kHz	Amplitude input range	±5 V <sub>peak</sub>	Effective amplitude	1 V (peak-to-peak) or more	Input waveform	50% duty ratio rectangular wave	Input resistance	Approx. 1 MΩ	Continuous maximum common mode voltage	±42 V <sub>peak</sub> or less	Accuracy	±(0.05% of reading + 1 mHz + 1 digit)
Item	Specification																																				
Connector type	BNC connector																																				
Input range	1 V, 2 V, 5 V, 10 V, and 20 V																																				
Effective input range	±110% of the measurement range However, ±20 V or less																																				
Input resistance	Approx. 1 MΩ																																				
Maximum allowable input	±20 V																																				
Continuous maximum common mode voltage	±42 V <sub>peak</sub> or less																																				
Accuracy	±(0.1% of reading + 0.2% of range)																																				
Temperature coefficient	±0.03% of range/°C																																				
Item	Specification																																				
Connector type	BNC connector																																				
Frequency range	2 Hz to 200 kHz																																				
Amplitude input range	±5 V <sub>peak</sub>																																				
Effective amplitude	1 V (peak-to-peak) or more																																				
Input waveform	50% duty ratio rectangular wave																																				
Input resistance	Approx. 1 MΩ																																				
Continuous maximum common mode voltage	±42 V <sub>peak</sub> or less																																				
Accuracy	±(0.05% of reading + 1 mHz + 1 digit)																																				
Torque signal	Same as the DC voltage of the revolution signal. * Motor evaluation cannot be executed during harmonic measurement.																																				

## D/A output (option)

Item	Specification
Number of outputs	30 channels Output item for each channel specifiable.
Accuracy	±(accuracy of each measurement function + 0.2% of FS)
Maximum output current	±0.1 mA
Temperature coefficient	±0.05% of FS/°C
Relationship between the output items and D/A output voltages	See section 15.1.

## Computation

Item	Specification
User-defined function	Compute numerical data of equations (up to four equations) that are created by combining the measurement function symbols and operators.
Delta computation	Applicable only during normal measurement. Compute other numerical data of the measured circuit from the computed results of the difference of the instantaneous values.
Equation for apparent power	Applicable only during normal measurement. Select the equation from $U_{rms} \times I_{rms}$ , $U_{mn} \times I_{mn}$ , $U_{dc} \times I_{dc}$ , and $U_{mn} \times I_{rms}$ .
Corrected Power	Correction of active power as defined by the applicable standard IEC76-1(1976), IEEE C57.12.90-1993, and IEC76-1(1993).
Phase difference display	Select whether to display the phase difference using lead and lag format or 360° format.
Equation for distortion factor	Set the denominator of the equation to the total waveform or fundamental waveform.

## 17.6 Functions

### Numerical Display

Item	Specification
Displayed items	Displays the numerical data of the measurement functions of sections 17.3 or 17.4.
Display resolution	60000
Number of displayed items	During normal measurement Select from 4, 8, 16, 42, 78, and All. During harmonic measurement Select from 4, 8, 16, single list, dual list, and $\Sigma$ list.
Scrolling of displayed items	During normal measurement Scroll to display the numerical data of measurement functions that cannot be displayed on one screen. Page scrolling is also possible. During harmonic measurement Scroll to display the numerical data of measurement functions that cannot be displayed on one screen. Page scrolling is also possible.
Resetting the display	Reset the display order of the numerical data to default.

### Waveform Display

Item	Specification
Retrieval of waveform display data	ON/OFF selectable.
Sample rate	Approx. 200 kS/s
Time axis	<ul style="list-style-type: none"><li>• During normal measurement In the range of 0.5 ms/div to 500 ms/div. However, less than or equal to 1/10 of the data update rate.</li><li>• During harmonic measurement Automatically determined from the PLL source and window width</li></ul>
Trigger	<ul style="list-style-type: none"><li>• Trigger type Edge type</li><li>• Trigger mode Select auto or normal.</li><li>• Trigger source Select from the voltage or current applied to the input element and external clock.</li><li>• Trigger slope Select from <math>\uparrow</math> (rising), <math>\downarrow</math> (falling), or <math>\uparrow\downarrow</math> (rising and falling).</li><li>• Trigger level<ul style="list-style-type: none"><li>• When the trigger source is a voltage or current applied to the input element Set in the range of <math>\pm 100\%</math> from the screen center (measurement range <math>\times 3</math>: the upper and lower limits of the screen). Resolution: 0.1%.</li><li>• When the trigger source is Ext Clk (external clock) TTL level. For the specifications of the external clock, see section 9.3.</li></ul></li></ul>
Vertical zoom on the waveform	Zoom in/out vertically for each voltage or current applied to the input element. Set the zoom rate in the range from 0.1 to 100 times.
Turning ON/OFF the waveform display	Select ON/OFF for each voltage or current applied to the input element.
Waveform display format	1, 2, 3, and 4 split window displays are possible.
Display interpolation of the waveform	Select dot or linear display.
Graticule	Select the grid and cross scale display.
Auxiliary display ON/OFF	Turn ON/OFF the upper and lower limits (scale value) and the waveform label.
Cursor measurement	Measure the value at the point where the cursor is placed on the waveform.

### Vector Display and Bar Graph Display

Item	Specification
Vector display	Applicable during harmonic measurement. Displays vectors of the phase difference of the fundamental waveforms.
Bar graph display	Applicable during harmonic measurement. Displays the bar graph of the amplitude of each harmonic.

### Trend Display

Displays the trend of the numerical data of the measurement function on a line graph.

### Simultaneous Display

Displays a combination of two displays from numerical, waveform, bar graph, and trend in the top and bottom halves of the divided screen.

### Data Store and Recall

Store the numerical data and waveform display data in the internal memory. Save the stored data to a storage medium<sup>\*1</sup>

Recall<sup>\*2</sup> the stored data from the internal memory.

\*1 Floppy disk, built-in hard disk, SCSI device, network drive, etc.  
(Built-in hard disk, SCSI, and Ethernet interface are optional.)

\*2 Cannot recall the data from a saved file.

### Data Save and Load

Save setup parameters, waveform display data, numerical data, and screen image data to a storage medium<sup>\*</sup>.

Load the saved setup parameters from the storage medium<sup>\*</sup>.

\* Floppy disk, built-in hard disk, SCSI device, network drive, etc.  
(Built-in hard disk, SCSI, and Ethernet interface are optional.)

### Printing of the Screen Image, Numerical Data List, and Bar Graph

Print the screen image, numerical data list, and bar graph using the built-in printer<sup>\*</sup>.

\* The built-in printer is optional.

### Ethernet Communications (Option)

Item	Specification
FTP client	Save setup parameters, waveform display data, numerical data, and screen image data to an FTP server (network drive) on the network. Load the setup parameters that have been saved to the FTP server.
FTP server	Access the WT1600 from a PC or workstation on the network and download files on the floppy disk, built-in hard disk, and SCSI device connected to the WT1600. However, an FTP client software is needed on the PC or workstation.
LPR client	Print the screen image on a network printer.
SMTP client	Periodically transmit the information of the WT1600 to a specified mail address.

## 17.7 Input/Output of the Master/Slave Synchronization Signal

Item	Specification
Connector type	BNC connector: Common to the master and slave
I/O level	TTL: Common to the master and slave
Output logic	<input type="checkbox"/> Negative logic, falling edge: Applicable to the master
Measurement start delay time	Within (100 ns + 1 sample period): Applicable to the master
Output hold time	Low level, 200 ns or more: Applicable to the master
Input logic	<input type="checkbox"/> Negative logic, falling edge: Applicable to the slave
Minimum pulse width	Low level, 200 ns or more: Applicable to the slave
Input delay time	Within (100 ns + 1 sample period): Applicable to the slave

## 17.8 External Clock Input

### Common

Item	Specification
Connector type	BNC connector
Input level	TTL

### Synchronization source (Ext Clk) during normal measurement

Item	Specification
Frequency range	Same as the measurement range as indicated in "Frequency Measurement" in section 17.6.
Input waveform	50% duty ratio rectangular wave

### PLL source (Ext Clk) during harmonic measurement

Item	Specification
Frequency range	10 Hz to 1 kHz
Input waveform	50% duty ratio rectangular wave

### Sampling clock (Smp Clk) during harmonic measurement

Item	Specification
Frequency range	Frequency equal to 2048 times the fundamental frequency of 0.5 Hz to 100 Hz
Input waveform	50% duty ratio rectangular wave

### Trigger

Item	Specification
Minimum pulse width	1 $\mu$ s
Trigger delay time	Within (1 $\mu$ s + 1 sample period)

---

## 17.9 RGB Video Signal (VGA) Output

Item	Specification
Connector type	D-sub 15 pin (receptacle)
Output type	VGA compatible

---

## 17.10 Built-in Floppy Disk

Item	Specification
Number of drives	1
Size	3.5"
Capacity	1.44 MB

---

## 17.11 Built-in Hard Disk (Option)

Item	Specification
Number of drives	1
Capacity	10 GB (IBM format)

---

## 17.12 SCSI (Option)

Item	Specification
Standard	SCSI (Small Computer System Interface) ANSI X3.131-1986
Connector type	Half pitch 50 pins (pin type)
Connector pin assignment	Unbalanced (single-ended), built-in terminator
SCSI devices* that can be used	HD drive: MS-DOS version 3.3 or later, or SCSI HD drive that can be formatted using EZ-SCSI. MO drive: 128/230/640 MB drive, MO medium uses semi-IBM format. ZIP drive PD drive

\* For further information, please contact your nearest YOKOGAWA dealer.

---

## 17.13 Ethernet Interface (Option)

Item	Specification
Number of communication ports	1
Connector type	RJ-45 connector
Electrical and mechanical specifications	Conforms to IEEE 802.3.
Transmission system	Ethernet 10BASE-T
Transmission rate	10 Mbps
Protocol	TCP/IP

---

## 17.14 Built-in Printer (Option)

Item	Specification
Printing system	Thermal line dot system
Dot density	8 dots/mm
Paper width	80 mm
Printing width	72 mm

---

## 17.15 GP-IB Interface

Item	Specification
Electrical and mechanical specifications	Conforms to IEEE St'd 488-1978 (JIS C 1901-1987).
Functional specifications	SH1, AH1, T6, L4, SR1, RL1, PP0, DC1, DT1, and C0
Protocol	Conforms to IEEE St'd 488.2-1987
Code	ISO (ASCII) code
Mode	Addressable mode
Address	0 to 30
Clear remote mode	Remote mode can be cleared by pressing LOCAL (except during Local Lockout).

For details on the specifications of the GP-IB interface, see the *Communications Interface User's Manual IM760101-11E*.

## 17.16 Serial (RS-232) Interface

Item	Specification
Connector type	D-sub 9-pin (plug)
Electrical specifications	Conforms to EIA-574 (9-pin EIA-232(RS-232))
Connection format	Point-to-point
Transmission mode	Full-duplex
Synchronization	Start-stop synchronization
Baud rate	Select from the following rates. 1200, 2400, 4800, 9600, and 19200 bps

For details on the specifications of the serial interface, see the *Communications Interface User's Manual IM760101-11E*.

## 17.17 General Specifications

Item	Specification
Warm-up time	Approximately 1 hour
Operating conditions	Temperature: 5 to 40° C Humidity: 20 to 80% RH when not using the printer, 35 to 80% RH when using the printer. (No condensation)
Operating altitude	2000 m or less
Storage environment	Temperature: -25 to 60° C Humidity: 20 to 80%RH (no condensation)
Rated supply voltage	100 to 120 VAC, 200 to 240 VAC
Permitted supply voltage range	90 to 132 VAC, 180 to 264 VAC
Rated supply voltage frequency	50/60 Hz
Permitted supply voltage frequency range	48 to 63 Hz
Maximum power consumption	150 VA (when using the built-in printer)
Insulation resistance	50 MΩ or more at 500 VDC Between power plug and case Between all voltage input terminals and case Between all current input terminals and case Between all voltage terminals and all current input terminals Between all torque and revolution signal input connectors and case Between all the torque signal input connectors and all the revolution signal input connectors
Withstand voltage	<ul style="list-style-type: none"> <li>1500 VAC at 50/60 Hz for one minute Between power plug and case</li> <li>3700 VAC at 50/60 Hz for one minute Between all voltage input terminals and case Between all current input terminals and case Between all voltage terminals and all current input terminals</li> </ul>
External dimensions (See section 17.18.)	Approx. 426 mm (W) × 177 mm (H) × 400 mm (D) (Excludes the handle and other projections.)
Weight	Approx. 15 kg (main unit, 6 input elements, and option installed)
Installation position	Horizontal (however, the stand can be used). Vertical position and stacking not allowed.
Battery backup	Setup parameters and internal time clock are backed up with lithium batteries.





# 17.18 External Dimensions

Unit: mm

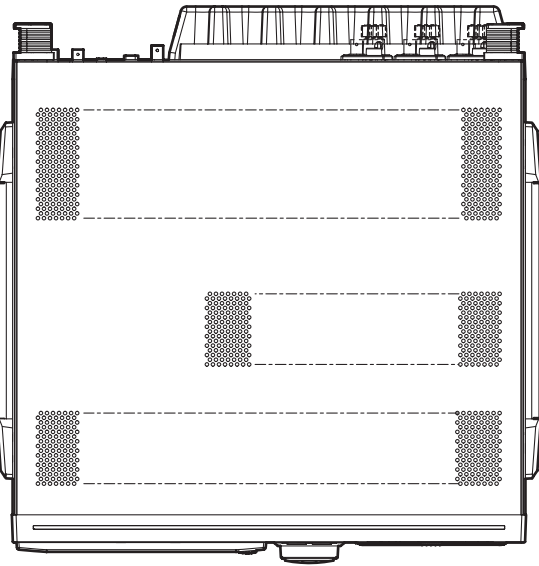

Rear Panel

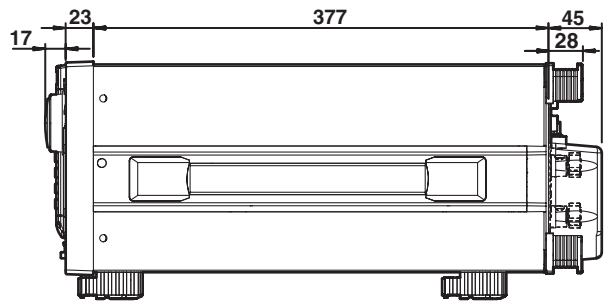
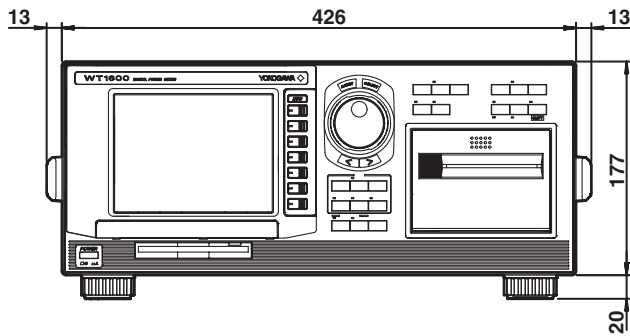
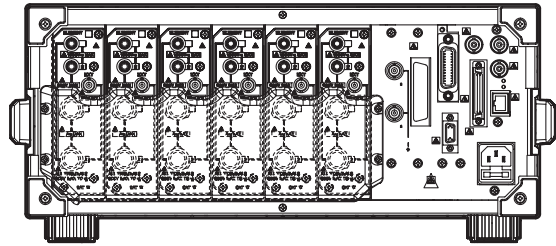

Dimensions with the JIS rack mount kit

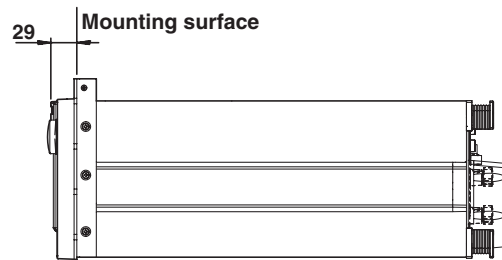
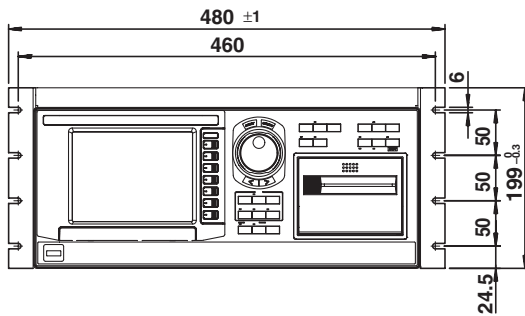

Dimensions with the EIA rack mount kit

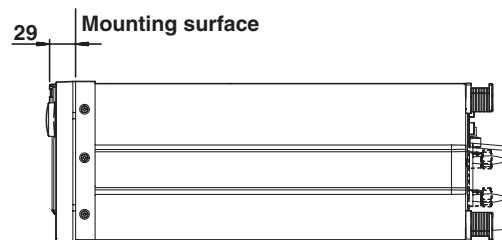
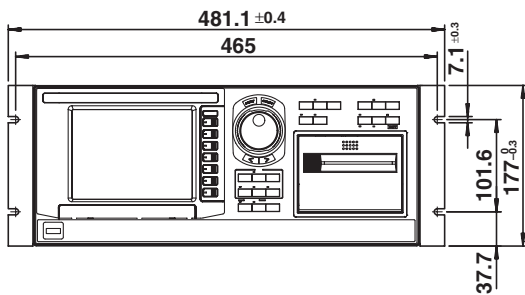

Unless otherwise specified, tolerance is ±3% (however, tolerance is ±0.3 mm when below 10 mm).

# Appendix 1 Symbols and Determination of Measurement Functions

## Measurement Functions during Normal Measurement

(Table 1/3)

Measurement Functions during Normal Measurement	Method of Determination, Equation					
<b>Voltage U [V]</b> True rms value <b>Urms</b> Rectified mean value calibrated to the rms value <b>Umn</b> Simple average <b>Udc</b> AC component <b>Uac</b> Maximum value <b>U+pk</b> Minimum value <b>U-pk</b>	<b>Urms</b>	<b>Umn</b>	<b>Udc</b>	<b>Uac</b>	<b>U+pk</b>	<b>U-pk</b>
	$\sqrt{\frac{1}{T} \int_0^T u(t)^2 dt}$	$\frac{\pi}{2\sqrt{2}} \frac{1}{T} \int_0^T  u(t)  dt$	$\frac{1}{T} \int_0^T u(t) dt$	$\sqrt{Urms^2 - Udc^2}$	Maximum	Minimum
<b>Current I [A]</b> True rms value <b>Irms</b> Rectified mean value calibrated to the rms value <b>Imn</b> Simple average <b>Idc</b> AC component <b>Iac</b> Maximum value <b>I+pk</b> Minimum value <b>I-pk</b>	<b>Irms</b>	<b>Imn</b>	<b>Idc</b>	<b>Iac</b>	<b>I+pk</b>	<b>I-pk</b>
	$\sqrt{\frac{1}{T} \int_0^T i(t)^2 dt}$	$\frac{\pi}{2\sqrt{2}} \frac{1}{T} \int_0^T  i(t)  dt$	$\frac{1}{T} \int_0^T i(t) dt$	$\sqrt{Irms^2 - Idc^2}$	Maximum	Minimum
Voltage frequency <b>fU (FreqU) [Hz]</b> Current frequency <b>fI (FreqI) [Hz]</b>	The voltage frequency ( <b>fU</b> ) and current frequency ( <b>fI</b> ) are measured using zero crossing detection.					
Voltage form factor <b>FfU</b> Current form factor <b>FfI</b>	Voltage form factor $FfU = \frac{Urms}{\frac{2\sqrt{2}}{\pi} Umn}$			Current form factor $FfI = \frac{Irms}{\frac{2\sqrt{2}}{\pi} Imn}$		
Voltage crest factor <b>CfU</b> Current crest factor <b>CfI</b>	Voltage crest factor $CfU = \frac{Upk}{Urms}$ <b>Upk = IU+pk</b> or <b>IU-pk</b> whichever is larger			Current crest factor $CfI = \frac{Ipk}{Irms}$ <b>Ipk = II+pk</b> or <b>II-pk</b> whichever is larger		
Active power <b>P [W]</b>	$\frac{1}{T} \int_0^T u(t) \cdot i(t) dt$					
Apparent power <b>S [VA]</b>	$Urms \cdot Irms$ $(Umn \cdot Imn)$ $(Udc \cdot Idc)$ $(Umn \cdot Irms)$ Combinations of rms, mn, and dc are selectable. See section 6.6.					
Reactive power <b>Q [var]</b>	$\sqrt{S^2 - P^2}$					
Power factor $\lambda$	$\frac{P}{S}$					
Phase difference $\phi$ [°]	$\cos^{-1} \left( \frac{P}{S} \right)$ The phase format can be displayed using Lead ( <b>D</b> )/Lag ( <b>G</b> ) format or <b>360°</b> format. See section 6.7.					
Impedance of the load circuit <b>Z [Ω]</b>	$\frac{Urms}{Irms}$					
Series resistance of the load circuit <b>Rs [Ω]</b>	$\frac{P}{Irms^2}$					
Series reactance of the load circuit <b>Xs [Ω]</b>	$\frac{Q}{Irms^2}$					
Parallel resistance of the load circuit <b>Rp [Ω] (=1/G)</b>	$\frac{Urms^2}{P}$					
Parallel reactance of the load circuit <b>Xp [Ω] (=1/B)</b>	$\frac{Urms^2}{Q}$					
Corrected power <b>Pc [W]</b>	IEC76-1(1976), IEEE C57.12.90-1993			IEC76-1(1993)		
	$\frac{P}{P1 + P2 \left( \frac{Urms}{Umn} \right)^2}$ <b>P1, P2:</b> Coefficients as defined in the applicable standard			$P \left( 1 + \frac{Umn - Urms}{Umn} \right)$		

(Continues to the next page)

(Table 2/3)

Measurement Functions during Normal Measurement		Method of Determination, Equation					
Integration	Integration time [h:m:s]	Elapsed time from the start of integration to stop					
	Watt hour [Wh] Wp Wp+ Wp-	$\int_0^{\text{Time}} u(t) \cdot i(t) dt$ <p>Wp is the sum of positive and negative watt hours. Wp+ is the sum of positive P (power consumed). Wp- is the sum of negative P (returned to the power supply, regenerated energy)</p>					
	Ampere hour [Ah] q q+ q-	$\sum_{N=0}^n I$ <p>q is the sum of positive and negative current hours. q+ is the sum of positive I (current hour). q- is the sum of negative I (current hour). The selected item from Irms, Imn, Idc, and Iac is applied to I. For the selection procedure, see section 6.10.</p>					
Σ Function	Wiring system	Single-phase, three-wire (1P3W)	Three-phase, three-wire (3P3W)	Three-voltage, three-current (3V3A)	Three-phase, four-wire (3P4W)		
	UΣ [V]	UrmsΣ	(Urms1 + Urms2) / 2		(Urms1 + Urms2 + Urms3) / 3		
		UmnΣ	(Umn1 + Umn2) / 2		(Umn1 + Umn2 + Umn3) / 3		
		UdcΣ	(Udc1 + Udc2) / 2		(Udc1 + Udc2 + Udc3) / 3		
		UacΣ	(Uac1 + Uac2) / 2		(Uac1 + Uac2 + Uac3) / 3		
	IΣ [A]	IrmsΣ	(Irms1 + Irms2) / 2		(Irms1 + Irms2 + Irms3) / 3		
		ImnΣ	(Imn1 + Imn2) / 2		(Imn1 + Imn2 + Imn3) / 3		
		IdcΣ	(Idc1 + Idc2) / 2		(Idc1 + Idc2 + Idc3) / 3		
		IacΣ	(Iac1 + Iac2) / 2		(Iac1 + Iac2 + Iac3) / 3		
	PΣ [W]	P1 + P2			P1 + P2 + P3		
	SΣ [VA]	S1 + S2	$\frac{\sqrt{3}}{2}(S1 + S2)$	$\frac{\sqrt{3}}{3}(S1 + S2 + S3)$	S1 + S2 + S3		
	QΣ [var]	Q1 + Q2			Q1 + Q2 + Q3		
	PcΣ [W]	Pc1 + Pc2			Pc1 + Pc2 + Pc3		
	WpΣ [Wh]	WpΣ	Wp1 + Wp2			Wp1 + Wp2 + Wp3	
		Wp+Σ	Wp+1 + Wp+2			Wp+1 + Wp+2 + Wp+3	
		Wp-Σ	Wp-1 + Wp-2			Wp-1 + Wp-2 + Wp-3	
qΣ [Ah]	qΣ	q1 + q2			q1 + q2 + q3		
	q+Σ	q+1 + q+2			q+1 + q+2 + q+3		
	q-Σ	q-1 + q-2			q-1 + q-2 + q-3		
$\lambda_{\Sigma} = \frac{P_{\Sigma}}{S_{\Sigma}}$ $\phi_{\Sigma} [^{\circ}] = \cos^{-1}\left(\frac{P_{\Sigma}}{S_{\Sigma}}\right)$ $Z_{\Sigma} [\Omega] = \frac{S_{\Sigma}}{I_{rms\Sigma}^2}$ $R_{s\Sigma} [\Omega] = \frac{P_{\Sigma}}{I_{rms\Sigma}^2}$		$X_{s\Sigma} [\Omega] = \frac{Q_{\Sigma}}{I_{rms\Sigma}^2}$ $R_{p\Sigma} [\Omega] = \frac{U_{rms\Sigma}^2}{P_{\Sigma}}$ $X_{p\Sigma} [\Omega] = \frac{U_{rms\Sigma}^2}{Q_{\Sigma}}$		$\eta$ (efficiency1) [%] = $\frac{P_{\Sigma B}}{P_{\Sigma A}} \cdot 100$ $1/\eta$ (efficiency 2) [%] = $\frac{P_{\Sigma A}}{P_{\Sigma B}} \cdot 100$			

(Continues to the next page)

**Note**

- Period T is the measurement period. For details on the measurement period, see section 1.2.
- u(t) and i(t) denote the sampled data of the voltage signal and the current signal, respectively.
- PΣA and PΣB denote the active power of the wiring units ΣA and ΣB, respectively. The assignment of input elements to wiring units ΣA and ΣB is determined by the number of input elements that are installed in the WT1600 and the selected wiring system pattern. For details, see section 1.3.
- The numbers 1, 2, and 3 in the equations UΣ, IΣ, PΣ, SΣ, QΣ, PcΣ, WpΣ, and qΣ indicate the case when input elements 1, 2, and 3 are set to the wiring system shown in the table. If elements 2, 3, and 4 are set to the wiring system shown in the table, replace the numbers 1, 2, and 3 with 2, 3, and 4, respectively. The same also holds true when using elements 5 and 6.
- For single phase models (one input element) and those with a 1P2W wiring system, the Σ functions' numerical data are the same as that of the elements that were assigned to wiring units ΣA, ΣB, and ΣC.
- With QΣ[var] calculation, the current at a given voltage is calculated as a negative value for a leading phase, and a positive value for lagging phase.

(Table 3/3)

Measurement Functions during Normal Measurement		Method of Determination, Equation
Motor Evaluation	Rotating Speed	<p>When the type of input signal from the revolution sensor is DC voltage (analog signal)  <b>Input voltage from the revolution sensor · Scaling factor</b>                      Scaling factor: Number of rotations per volt of input voltage</p> <p>When the type of input signal from the revolution sensor is pulse count  <b><u>Number of input pulses from the revolution sensor per minute</u></b> · Scaling factor  <b>Number of pulses per rotation</b>                      Scaling factor: When the signal of the gear ratio or revolution sensor is a converted signal, you can specify the gear ratio for the scaling factor to determine the rotating speed before the gear change.</p>
	Torque	<p><b>Input voltage from the torque meter · Scaling factor</b>                      Scaling factor: torque per volt of input voltage</p>
	Synchronized speed (Sync)	<p><b><u>120 · Frequency of the frequency measurement source (Hz)</u></b>  <b>Motor's number of poles</b></p> <ul style="list-style-type: none"> <li>• The unit of synchronized speed is fixed to "min<sup>-1</sup> (or rpm)."</li> <li>• Normally, the frequency measurement source is set to the voltage or current that is supplied to the motor. The synchronized speed may not be determined correctly if a different signal is specified.</li> </ul>
	Slip [%]	<p><b><u>Sync – Speed</u></b> · 100  <b>Sync</b></p>
	Motor output P <sub>m</sub>	<p><b><u>2π · Speed · Torque</u></b> · Scaling factor                      60</p> <p>When the unit of <b>Speed</b> is "min<sup>-1</sup> (or rpm)," the unit of <b>Torque</b> is "N·m," and the scaling factor is 1, the unit of motor output <b>P<sub>m</sub></b> is "W."                      For products with ROM version 1.05 or earlier, the equation for P<sub>m</sub> is as follows:  <b>P<sub>m</sub> = Speed + Torque × Scaling factor</b></p>
	Motor efficiency [%] or total efficiency [%]	<p><math>\eta_{mA} = \frac{P_m}{P_{\Sigma A}} \cdot 100</math>  <math>\eta_{mB} = \frac{P_m}{P_{\Sigma B}} \cdot 100</math></p> <ul style="list-style-type: none"> <li>• Motor efficiency is the ratio of the motor output with respect to the power consumed by the motor.</li> <li>• Total efficiency is the ratio of the motor output versus the power consumed by the motor as well as the converter through which power is fed to the motor.</li> <li>• If <b>P<sub>ΣA</sub></b> is the power to the converter and the motor and <b>P<sub>ΣB</sub></b> is the power to the motor, <math>\eta_{mA}</math> and <math>\eta_{mB}</math> are the total efficiency and motor efficiency, respectively. Conversely, if <b>P<sub>ΣB</sub></b> is the power to the converter and the motor and <b>P<sub>ΣA</sub></b> is the power to the motor, <math>\eta_{mB}</math> and <math>\eta_{mA}</math> are the total efficiency and motor efficiency, respectively.</li> </ul>

Measurement Functions during Harmonic Measurement

(Table 1/2)

Measurement Functions during Harmonic Measurement	Method of Determination, Equation			Total {No ( )}
	Characters/values inside the ( ) of the measurement function			
	dc (When k = 0)	1 (When k = 1)	k (When k = 2 to max)	
Voltage U( ) [V]	$U(\text{dc}) = U_r(0)$	$U(k) = \sqrt{U_r(k)^2 + U_j(k)^2}$		$U = \sqrt{\sum_{k=\text{min}}^{\text{max}} U(k)^2}$
Current I( ) [A]	$I(\text{dc}) = I_r(0)$	$I_r(k)^2 + I_j(k)^2 = \sqrt{\quad}$		$I = \sqrt{\sum_{k=\text{min}}^{\text{max}} I(k)^2}$
Active power P( ) [W]	$P(\text{dc}) = U_r(0) \cdot I_r(0)$	$P(k) = U_r(k) \cdot I_r(k) + U_j(k) \cdot I_j(k)$		$P = \sum_{k=\text{min}}^{\text{max}} P(k)$
Apparent power S( ) [VA]	$S(\text{dc}) = P(\text{dc})$	$S(k) = \sqrt{P(k)^2 + Q(k)^2}$		$S = \sqrt{P^2 + Q^2}$
Reactive power Q( ) [var]	$Q(\text{dc}) = 0$	$Q(k) = U_r(k) \cdot I_j(k) - U_j(k) \cdot I_r(k)$		$Q = \sum_{k=\text{min}}^{\text{max}} Q(k)$
Power factor $\lambda( )$	$\lambda(\text{dc}) = \frac{P(\text{dc})}{S(\text{dc})}$	$\lambda(k) = \frac{P(k)}{S(k)}$		$\lambda = \frac{P}{S}$
Phase difference $\phi( )$ [°]	—	$\phi(k) = \cos^{-1} \left\{ \frac{P(k)}{S(k)} \right\}$		$\phi = \cos^{-1} \left( \frac{P}{S} \right)$
Phase difference with respect to U(1) $\phi_U( )$ [°]	—	Phase difference $U(k)$ with respect to $\phi_U(k) = U(1)$		—
Phase difference with respect to I(1) $\phi_I( )$ [°]	—	Phase difference $I(k)$ with respect to $\phi_I(k) = I(1)$		—
Impedance of the load circuit $Z( )$ [Ω]	$Z(\text{dc}) = \left  \frac{U(\text{dc})}{I(\text{dc})} \right $	$Z(k) = \left  \frac{U(k)}{I(k)} \right $		—
Serial resistance of the load circuit $R_s( )$ [Ω]	$R_s(\text{dc}) = \frac{P(\text{dc})}{I(\text{dc})^2}$	$R_s(k) = \frac{P(k)}{I(k)^2}$		—
Serial reactance of the load circuit $X_s( )$ [Ω]	$X_s(\text{dc}) = \frac{Q(\text{dc})}{I(\text{dc})^2}$	$X_s(k) = \frac{Q(k)}{I(k)^2}$		—
Parallel resistance of the load circuit $R_p( )$ [Ω] (= 1/G)	$R_p(\text{dc}) = \frac{U(\text{dc})^2}{P(\text{dc})}$	$R_p(k) = \frac{U(k)^2}{P(k)}$		—
Parallel reactance of the load circuit $X_p( )$ [Ω] (= 1/B)	$X_p(\text{dc}) = \frac{U(\text{dc})^2}{Q(\text{dc})}$	$X_p(k) = \frac{U(k)^2}{Q(k)}$		—

(Continues to the next page)

**Note**

- k, r, and j denote the harmonic order, real part, and imaginary part, respectively.
- min denotes the minimum order. You can select 0 (DC component) or 1 (fundamental signal component) for the minimum order. For details, see section 7.5.
- max denotes the upper limit of harmonic order under analysis (see section 17.6). The upper limit is determined automatically (maximum is 100) by the frequency of the PLL source.

(Table 2/2)

Measurement Functions during Harmonic Measurement	Method of Determination, Equation					
	Characters/values inside the ( ) of the measurement function are either dc (k = 0) or k (k = 1 to max)					
	When the denominator of the equation for the distortion factor is Total		When the denominator of the equation for the distortion factor is Fundamental			
Harmonic distortion factor of voltage <b>Uhdf( ) [%]</b>	$\frac{U(k)}{U} \cdot 100$		$\frac{U(k)}{U(1)} \cdot 100$			
Harmonic distortion factor of current <b>lhdf( ) [%]</b>	$\frac{I(k)}{I} \cdot 100$		$\frac{I(k)}{I(1)} \cdot 100$			
Harmonic distortion factor of active power <b>Phdf( ) [%]</b>	$\frac{P(k)}{P} \cdot 100$		$\frac{P(k)}{P(1)} \cdot 100$			
Total harmonic distortion of voltage <b>Uthd [%]</b>	$\frac{\sqrt{\sum_{k=2}^{\max} U(k)^2}}{U} \cdot 100$		$\frac{\sqrt{\sum_{k=2}^{\max} U(k)^2}}{U(1)} \cdot 100$			
Total harmonic distortion of current <b>lthd [%]</b>	$\frac{\sqrt{\sum_{k=2}^{\max} I(k)^2}}{I} \cdot 100$		$\frac{\sqrt{\sum_{k=2}^{\max} I(k)^2}}{I(1)} \cdot 100$			
Total harmonic distortion of active power <b>Pthd [%]</b>	$\left  \frac{\sum_{k=2}^{\max} P(k)}{P} \right  \cdot 100$		$\left  \frac{\sum_{k=2}^{\max} P(k)}{P(1)} \right  \cdot 100$			
Telephone harmonic factor of voltage <b>Uthf [%]</b> Telephone harmonic factor of current <b>lthf [%]</b>	$U_{thf} = \frac{1}{U} \sqrt{\sum_{k=1}^{\max} \{\lambda(k) \cdot U(k)\}^2} \cdot 100$		$l_{thf} = \frac{1}{I} \sqrt{\sum_{k=1}^{\max} \{\lambda(k) \cdot I(k)\}^2} \cdot 100$			
$\lambda(k)$ : Coefficient as defined by the applicable standard (IEC34-1(1996))						
Telephone influence factor of voltage <b>Utif</b> Telephone influence factor of current <b>litif</b>	$U_{tif} = \frac{1}{U} \sqrt{\sum_{k=1}^{\max} \{T(k) \cdot U(k)\}^2}$		$l_{tif} = \frac{1}{I} \sqrt{\sum_{k=1}^{\max} \{T(k) \cdot I(k)\}^2}$			
$T(k)$ : Coefficient as defined by the applicable standard (IEEE Std 100(1992))						
Harmonic voltage factor <b>hvf [%]</b> Harmonic current factor <b>hcf [%]</b>	$h_{vf} = \frac{1}{U} \sqrt{\sum_{k=2}^{\max} \frac{U(k)^2}{k}} \cdot 100$		$h_{cf} = \frac{1}{I} \sqrt{\sum_{k=2}^{\max} \frac{I(k)^2}{k}} \cdot 100$			
Voltage frequency <b>fU (FreqU) [Hz]</b> Current frequency <b>fI (FreqI) [Hz]</b>	The frequency of up to three signals including the signals selected for the PLL source as <b>fU</b> (voltage frequency) or <b>fI</b> (current frequency) can be measured. You can also select to measure only three sets of voltage frequencies or only three sets of current frequencies.					
<b>Σ Functions</b>	Wiring system	Single-phase, three-wire (1P3W)	Three-phase, three-wire (3P3W)	Three-voltage, three-current(3V3A)	Three-phase, four-wire (3P4W)	
	<b>UΣ [V]</b>	$(U1 + U2) / 2$		$(U1 + U2 + U3) / 3$		
	<b>IΣ [A]</b>	$(I1 + I2) / 2$		$(I1 + I2 + I3) / 3$		
	<b>PΣ [W]</b>	$P1 + P2$			$P1 + P2 + P3$	
	<b>SΣ [VA]</b>	$\sqrt{P\Sigma^2 + Q\Sigma^2}$				
	<b>QΣ [var]</b>	$Q1 + Q2$			$Q1 + Q2 + Q3$	
	$\lambda\Sigma$	$\frac{P\Sigma}{S\Sigma}$				

**Note**

- k, r, and j denote the harmonic order, real part, and imaginary part, respectively.
- max denotes the upper limit of harmonic order under analysis (see section 17.6). The upper limit is determined automatically (maximum is 100) by the frequency of the PLL source.
- The numbers 1, 2, and 3 in the equations UΣ, IΣ, PΣ, SΣ, and QΣ indicate the case when input elements 1, 2, and 3 are set to the wiring system shown in the table. If elements 2, 3, and 4 are set to the wiring system shown in the table, replace the numbers 1, 2, and 3 with 2, 3, and 4, respectively. The same also holds true when using elements 5 and 6.

## Appendix 2 Determination of Delta Computation

### Delta Computation Type, Sampled Data, and Measurement Function of Delta Computation

The sampled data in the table are substituted into the equations on the next page to derive the computed results. The synchronization source for the delta computation is the synchronization source (Sync Src) that is assigned to the first input element (smallest number) of the wiring unit on which delta computation is to be performed.

Delta Computation Type	Sampled Data That Are Substituted into the Equations on the Next Page		Data Determined by the Delta Computation and the Measurement Function Symbols Representing the Data		Notes
	u(t)	i(t)			
3P3W ▷3V3A	$u_1 - u_2$	$-i_1 - i_2$	Line voltage of the 3rd phase	$\Delta U_{rms1}$ $\Delta I_{rms1}$ $\Delta U_{mn1}$ $\Delta I_{mn1}$ $\Delta U_{dc1}$ $\Delta I_{dc1}$ $\Delta U_{ac1}$ $\Delta I_{ac1}$	Presumption $u_1 + u_2 + u_3 = 0$ $i_1 + i_2 + i_3 = 0$
Delta ▷Star	$u_1 - \frac{(u_1+u_2)}{3}$	—	Phase voltage of each phase Line current of the neutral conductor	$\Delta U_{rms1}$ $\Delta U_{mn1}$ $\Delta U_{dc1}$ $\Delta U_{ac1}$	Presumption $u_1 + u_2 + u_3 = 0$
	$u_2 - \frac{(u_1+u_2)}{3}$	—		$\Delta U_{rms2}$ $\Delta U_{mn2}$ $\Delta U_{dc2}$ $\Delta U_{ac2}$	
	$-\frac{(u_1+u_2)}{3}$	—		$\Delta U_{rms3}$ $\Delta U_{mn3}$ $\Delta U_{dc3}$ $\Delta U_{ac3}$	
	—	$i_1 + i_2 + i_3$		$\Delta I_{rms4}$ $\Delta I_{mn4}$ $\Delta I_{dc4}$ $\Delta I_{ac4}$	
Star ▷Delta	$u_1 - u_2$	—	Phase voltage of each phase Line current of the neutral conductor	$\Delta U_{rms1}$ $\Delta U_{mn1}$ $\Delta U_{dc1}$ $\Delta U_{ac1}$	Presumption $u_1 + u_2 + u_3 = 0$
	$u_2 - u_3$	—		$\Delta U_{rms2}$ $\Delta U_{mn2}$ $\Delta U_{dc2}$ $\Delta U_{ac2}$	
	$u_3 - u_1$	—		$\Delta U_{rms3}$ $\Delta U_{mn3}$ $\Delta U_{dc3}$ $\Delta U_{ac3}$	
	—	$i_1 + i_2 + i_3$		$\Delta I_{rms4}$ $\Delta I_{mn4}$ $\Delta I_{dc4}$ $\Delta I_{ac4}$	

#### Note

- You can select the delta computation target from wiring units  $\Sigma A$ ,  $\Sigma B$ , and  $\Sigma C$ . The input element that is assigned to the selected element is the element on which delta computation is performed. The numbers 1, 2, and 3 that are attached to sampled data u and i in the above table indicate that elements 1, 2, and 3 are target elements on which delta computation is performed. If the target elements of delta computation are 2, 3, and 4, replace the numbers 1, 2, and 3 that are attached to sampled data u and i with 2, 3, and 4, respectively. The same also holds true when elements 5 and 6 are targets.
- $u_1$ ,  $u_2$ ,  $u_3$  denote the sampled data of voltage of elements 1, 2, and 3, respectively.  $i_1$ ,  $i_2$ , and  $i_3$  denote the sampled data of current of elements 1, 2, and 3, respectively.
- The number (1, 2, 3, and 4) that is attached to the measurement function symbol of the delta computation has no relation to the element number.

Computed Item	Equation	Computed Item	Equation
$\Delta U_{rms}$	$\sqrt{\frac{1}{T} \int_0^T \{u(t)\}^2 dt}$	$\Delta I_{rms}$	$\sqrt{\frac{1}{T} \int_0^T \{i(t)\}^2 dt}$
$\Delta U_{mn}$	$\frac{\pi}{2\sqrt{2}} \frac{1}{T} \int_0^T  u(t)  dt$	$\Delta I_{mn}$	$\frac{\pi}{2\sqrt{2}} \frac{1}{T} \int_0^T  i(t)  dt$
$\Delta U_{dc}$	$\frac{1}{T} \int_0^T u(t) dt$	$\Delta I_{dc}$	$\frac{1}{T} \int_0^T i(t) dt$
$\Delta U_{ac}$	$\sqrt{\Delta U_{rms}^2 - \Delta U_{dc}^2}$	$\Delta I_{ac}$	$\sqrt{\Delta I_{rms}^2 - \Delta I_{dc}^2}$

**Note**

- If the sampled data used in the computation does not exist (for example, when the input element is not installed), the sampled data is considered to be 0 for the computation.
- It is recommended that the measurement range and scaling (transformation ratio and coefficients) of the elements on which delta computation is performed be set the same as much as possible. Using a different measurement range or scaling causes the measurement resolution of the sampled data to be different. In effect, the computation result will have errors.

**Display Format When Set to All Display**

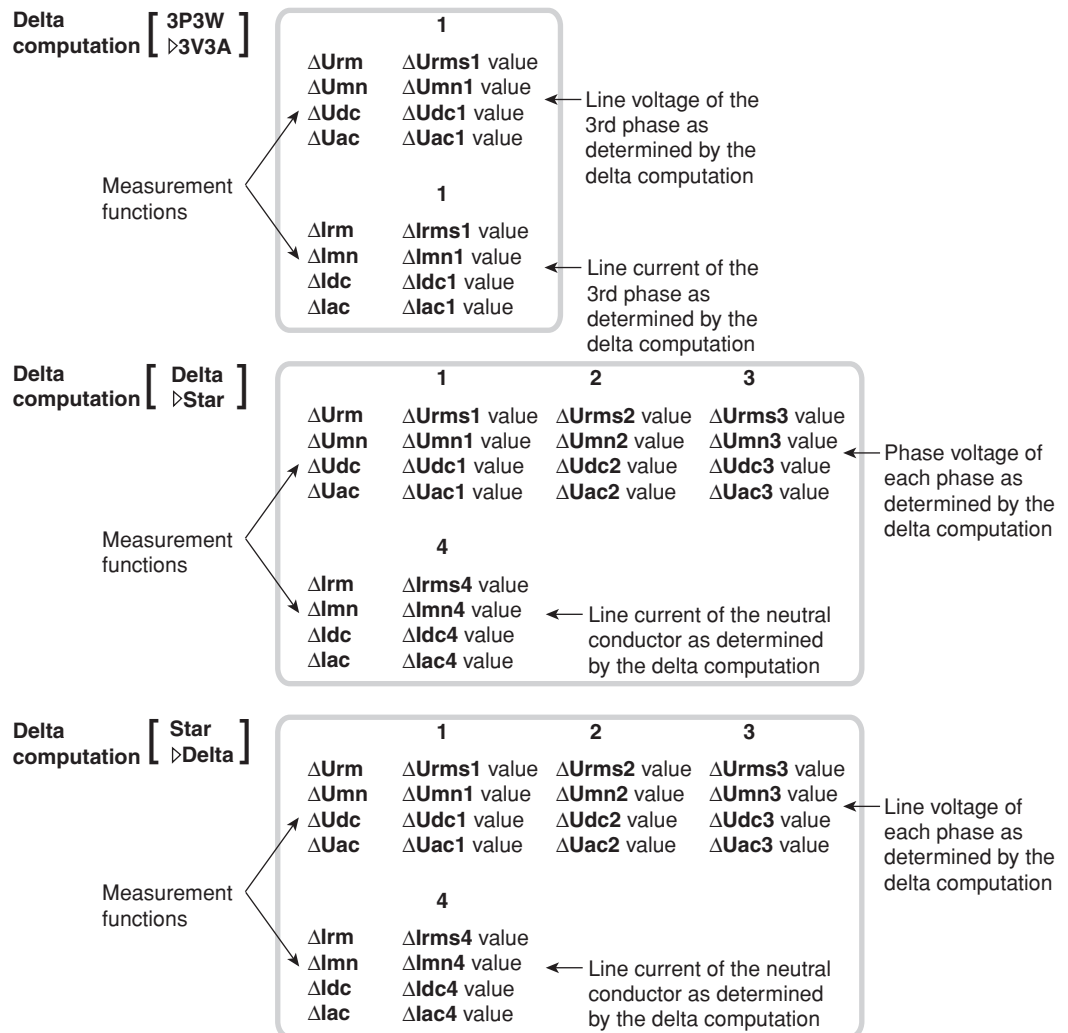



# Appendix 3 List of Initial Settings and Display Order of Numerical Data

## Initial Settings (Factory Default)

Item	Setting	
RANGE	For a 5-A input element	For a 50-A input element
Element Object	Element1	Element1
U Range	1000 V	1000 V
Terminal	Direct	Direct
I Range	5 A	50 A
Sen Range	10 V	10 V
SCALING		
Element Object	Element1	
Sensor Ratio	10.0000 mV/A	
Scaling	Off	
Pt Ratio	1.0000	
Ct Ratio	1.0000	
Scaling Factor	1.0000	
WIRING	Pattern1	
FILTER		
Element Object	Element1	
Line Filter	Off	
Zero Cross Filter	Off	
AVG		
Averaging	Off	
Averaging Type	Exp. (only during normal measurement)	
Exp. Count	2 (only during normal measurement)	
Lin. Count	8 (only during normal measurement)	
MEASURE		
Freq. Item	During normal measurement U1, I1, U2	During harmonic measurement U1, I1, U2 (up to 3 items including PLL Source)
User Defined		
Function1	Off	Off
Unit1	V	V
Expression1	URMS(E1)	U(E1,OR1)
Function2	Off	Off
Unit2	A	A
Expression2	IRMS(E1)	I(E1,OR1)
Function3	Off	Off
Unit3	V	W
Expression3	UPPK(E1)	P(E1,OR1)
Function4	Off	Off
Unit4	A	VA
Expression4	IPPK(E1)	S(E1,OR1)
ΔMeasure		
Object	ΣA	—
Type	Off	—
S Formula	Urms*Irms	—
Pc Formula	IEC76-1(1976)	—
P1 and P2 of IEC76-1 (1993)	P1 = 0.5000, P2 = 0.5000	—
Phase	180 Lead/Lag	—
Sync Measure	Master	Master

### Appendix 3 List of Initial Settings and Display Order of Numerical Data

Item	Setting	
<b>INTEGRATOR</b>		
Integrator Status	Reset status	
<b>INTEG SET</b>		
Mode	Normal	
Timer Setting	00000:00:00	
Independent Mode	Off	
Start Time	2001/01/01 00:00:00	
End Time	2001/01/01 01:00:00	
Current Mode	RMS	
Auto Cal	Off	
D/A Rated Time	00001:00:00T (displayed when the optional D/A output is installed)	
<b>SYNC SRC</b>		
Element Object	Element1	
Sync Source	I1	
<b>DISPLAY-Numeric</b>		
	During normal measurement	During harmonic measurement
Format	Numeric	Numeric
Item Amount	4(2)	4(2)
Norm Item No.	1	—
Harm Item No.	—	1
Function	Urms	U
Element	Element1	Element1
Order	—	1
<b>DISPLAY-Wave Setting</b>		
Wave Display	On	
On	U1 to I6, Speed, Torque	
Wave Format	Single	
Interpolate	Line	
Graticule	Grid(田)	
Scale Value	On	
Trace Label	Off	
Wave Mapping	Mode	
Mode	Auto	
User Setting	U1:0, I1:0, U2:1, I2:1, U3:2, I3:2, U4:3, I4:3, U5:0, I5:0, U6:1, I6:1, Speed:2, Torque:2	
<b>DISPLAY-Bar Setting</b>		
Bar Format	Single	
Bar Item No.	1	
Function	U	
Element	Element1	
Start Order	1	
End Order	100	
<b>DISPLAY-Vector Setting</b>		
Numeric	On	
U Mag	1.000	
I Mag	1.000	
<b>DISPLAY-Trend Setting</b>		
Trend Display	On	
On	T1 to T8	
Trend Format	Single	
Trend Sampling	Off	
Trend T/div	3 s/div (during normal measurement)	
Trend P/div	50 (during harmonic measurement)	
	During normal measurement	During harmonic measurement
Trend Object	T1	T1
Function	Urms	U
Element	Element1	Element1
Order	—	1
Scaling	Auto	Auto
Upper Scale	1.0000E+02	1.0000E+02
Lower Scale	-1.0000E+02	-1.0000E+02

### Appendix 3 List of Initial Settings and Display Order of Numerical Data

Item	Setting	
<b>HOLD</b>		
Hold	Off	
<b>UPDATE RATE</b>		
Update Rate	500 ms	
<b>WAVE</b>		
Wave Sampling	Off	
Time/div	0.5 ms (only during normal measurement)	
<b>Trigger</b>		
Mode	Auto	
Source	U1	
Slope	Rise	
Level	0.0%	
<b>V Zoom &amp; Position</b>		
Element Object	Element1	
(U) V Zoom	×1	
(U) Position	0.00%	
(I) V Zoom	×1	
(I) Position	0.00%	
Trend Sampling	Off	
<b>CURSOR (for Wave)</b>		
Wave Cursor	Off	
Wave C1 Trace	U1	
Wave C2 Trace	I1	
Cursor Path	Max	
	During normal measurement	During harmonic measurement
Wave C1 +	2.00 ms	10
Wave C2 ×	8.00ms	490
<b>CURSOR (for Bar)</b>		
Bar Cursor	Off	
Bar C1 +	1 order	
Bar C2 ×	15 order	
<b>CURSOR (for Trend)</b>		
Trend Cursor	Off	
Trend C1 Trace	T1	
Trend C2 Trace	T2	
Trend C1 +	6	
Trend C2 ×	54	
<b>HARMONICS</b>		
Mode	Off	
Object	ΣA	
PLL Source	U1	
Min Order	1	
Max Order	100	
Thd Formula	1/Total	
Window Width	8192	
<b>STORE</b>		
Store Status	Off	
<b>STORE SET</b>		
Mode	Store	
Store To	Memory	
<b>Store Setting</b>		
Mode	Manual	
Count	100	
Store Interval	00:00:00	
Store Item	Numeric	
List Item	Element1:On, U:On	
<b>MAX HOLD</b>		
Max Hold	Off	
<b>NULL</b>		
Null	Off	

### Appendix 3 List of Initial Settings and Display Order of Numerical Data

Item	Setting
MOTOR SET (displayed when the optional motor evaluation function is installed)	
Range (Speed)	20 V
Range (Torque)	20 V
Sense Type	Analog
Pulse Range	10000.0000
Line Filter	Off
Scaling(Speed)	1.0000
Scaling(Torque)	1.0000
Scaling(Pm)	1.0000
Unit (Speed)	rpm
Unit (Torque)	Nm
Unit (Pm)	W
Pulse N	60
Pole	2
Sync Speed	I1
Sync Source	None

#### Settings That Are Not Initialized through Initialization (MISC-Initialize Settings)

Item	Setting
FILE	
File Item	Setup
Data Type	Binary (when File Item is Wave) ASCII (when File Item is Numeric)
COPY MENU	
Copy To	File
Format	TIFF (when Copy To is File)
Color	Off (when Copy To is File)
Information	Off (when Copy To is Printer)
Format	ESC-P2 (when Copy To is Net Print)
Color	Off (when Copy To is Net Print)
MISC	
Communication	
GP-IB	
Address	1
RS232	
Band Rate	19200
Format	8-No-1
Rx-Tx	No-No
Terminator	Cr+Lf
Date/Time	
Display	On
Config	
Message	ENG
LCD Brightness	2
Crest Factor	CF3
Key Lock	OFF
Graph Color	
Mode	Default
Text Color	
Mode	Preset 1
SCSI	
Own ID	6 (the optional built-in hard disk is fixed to 4)
HDD Motor	On (displayed when the optional built-in hard disk is installed)

**Display Order of the Numerical Data**

- When the order of the numerical data is reset, the measurement function data are displayed in the order given in the next table.
- The measurement function data of element 1 is displayed.

**During Normal Measurement**

<b>Order</b>	<b>Measurement Function</b>
1	Urms1
2	Umn(mean)1
3	Udc1
4	Uac1
5	Irms1
6	Imn(mean)1
7	Idc1
8	Iac1
9	P1
10	S1
11	Q1
12	$\lambda$ 1
13	$\phi$ 1
14	fU(FreqU)1
15	fl(Freql)1
16	U+pk1
17	U-pk1
18	I+pk1
19	I-pk1
20	CfU1
21	Cfl1
22	FfU1
23	Ffl1
24	Z1
25	Rs1
26	Xs1
27	Rp1
28	Xp1
29	Pc1
30	Time1
31	Wp1
32	WP+1
33	WP-1
34	q1
35	q+1
36	q-1
37	$\eta$
38	1/ $\eta$
39	F1
40	F2
41	F3
42	F4
43	$\Delta$ Urms1
44	$\Delta$ Umn(mean)1
45	$\Delta$ Udc1
46	$\Delta$ Uac1
47	$\Delta$ Irms1
48	$\Delta$ Imn(mean)1
49	$\Delta$ Idc1
50	$\Delta$ Iac1
51 to 100	-----

### Appendix 3 List of Initial Settings and Display Order of Numerical Data

The following data is displayed on models with the motor evaluation function.

Order	Measurement Function
51	Speed
52	Torque
53	Sync
54	Slip
55	Pm
56	$\eta$ mA
57	$\eta$ mB

#### During Harmonic Measurement

Order	Measurement Functions (Order <sup>*</sup> )
1	U1
2	I1
3	P1
4	S1
5	Q1
6	U1(1)
7	I1(1)
8	P1(1)
9	S1(1)
10	Q1(1)
11	$\lambda$ 1(1)
12	$\phi$ 1(1)
13	$\phi$ U1(2)
14	$\phi$ I1(2)
15	fU1(1)
16	fI1(1)
17	Z1(1)
18	Rs1(1)
19	Xs1(1)
20	Rp1(1)
21	Xp1(1)
22	Uhdf1(1)
23	Ihdf1(1)
24	Phdf1(1)
25	Uthd1
26	Ithd1
27	Pthd1
28	Uthf1
29	Ithf1
30	Utif1
31	Itif1
32	hvf1
33	hcf1
34	$\phi$ U1-U2
35	$\phi$ U1-U3
36	$\phi$ U1-I1
37	$\phi$ U1-I2
38	$\phi$ U1-I3
39	F1
40	F2
41	F3
42	F4
43 to 100	-----

\* Harmonic orders are displayed inside parentheses.

## Appendix 4 ASCII Header File Format

When waveform display data (Wave) is saved, the following two files are automatically created in the directory.

- Waveform display data file (.wvf)
- ASCII header file (.hdr)

The ASCII header files explained here cannot be viewed on the WT1600. Use the data such as when analyzing the waveforms on your PC.

//YOKOGAWA ASCII FILE FORMAT

\$PublicInfo

FormatVersion 1.11  
Model WT1600  
Endian Big  
DataFormat Trace  
GroupNumber 3  
TraceTotalNumber 12  
DataOffset 4096

\$Group1

TraceNumber	4			
BlockNumber	1			
TraceName	U1	I1	U2	I2
BlockSize	1002	1002	1002	1002
VResolution	1.000000E+00	1.000000E+00	1.000000E+00	1.000000E+00
VOffset	0.000000E+00	0.000000E+00	0.000000E+00	0.000000E+00
VDataType	FS4	FS4	FS4	FS4
VUnit	V	A	V	A
VPlusOverData	?	?	?	?
VMinusOverData	?	?	?	?
VIllegalData	?	?	?	?
VMaxData	9.000000e+02	3.000000e+03	3.000000e+03	1.500000e+02
VMinData	-9.000000e+02	-3.000000e+03	-3.000000e+03	-1.500000e+02
HResolution	2.000000E-05	2.000000E-05	2.000000E-05	2.000000E-05
HOffset	0.000000E+00	0.000000E+00	0.000000E+00	0.000000E+00
HUnit	sec	sec	sec	sec
Date	2001/06/30	2001/06/30	2001/06/30	2001/06/30
Time	07:03:03	07:03:03	07:03:03	07:03:03

\$Group2

TraceNumber	4			
BlockNumber	1			
TraceName	U3	I3	U4	I4
BlockSize	1002	1002	1002	1002
VResolution	1.000000E+00	1.000000E+00	1.000000E+00	1.000000E+00

VOffset	0.000000E+00	0.000000E+00	0.000000E+00	0.000000E+00
VDataType	FS4	FS4	FS4	FS4
VUnit	V	A	V	A
VPlusOverData	?	?	?	?
VMinusOverData	?	?	?	?
VIllegalData	?	?	?	?
VMaxData	3.000000e+03	1.500000e+01	3.000000e+03	1.500000e+01
VMinData	-3.000000e+03	-1.500000e+01	-3.000000e+03	-1.500000e+01
HResolution	2.000000E-05	2.000000E-05	2.000000E-05	2.000000E-05
HOffset	0.000000E+00	0.000000E+00	0.000000E+00	0.000000E+00
HUnit	sec	sec	sec	sec
Date	2001/06/30	2001/06/30	2001/06/30	2001/06/30
Time	07:03:03	07:03:03	07:03:03	07:03:03
\$Group3				
TraceNumber	4			
BlockNumber	1			
TraceName	U5	I5	U6	I6
BlockSize	1002	1002	1002	1002
VResolution	1.000000E+00	1.000000E+00	1.000000E+00	1.000000E+00
VOffset	0.000000E+00	0.000000E+00	0.000000E+00	0.000000E+00
VDataType	FS4	FS4	FS4	FS4
VUnit	V	A	V	A
VPlusOverData	?	?	?	?
VMinusOverData	?	?	?	?
VIllegalData	?	?	?	?
VMaxData	3.000000e+03	1.500000e+02	3.000000e+03	1.500000e+02
VMinData	-3.000000e+03	-1.500000e+02	-3.000000e+03	-1.500000e+02
HResolution	2.000000E-05	2.000000E-05	2.000000E-05	2.000000E-05
HOffset	0.000000E+00	0.000000E+00	0.000000E+00	0.000000E+00
HUnit	sec	sec	sec	sec
Date	2001/08/30	2001/08/30	2001/08/30	2001/08/30
Time	07:03:03	07:03:03	07:03:03	07:03:03
\$PrivateInfo				
Mode	Wave Normal			
ModelVersion	1.01			

(Note) The header file is a common file used by YOKOGAWA's measuring instruments. Therefore, data that is not required by the WT1600 (0s) is also included.



**\$PublicInfo (Common Information)**

FormatVersion: Header file version No. (common to YOKOGAWA's header files)  
Model: Model name  
Endian: Endian mode when saving data (Big)<sup>\*1</sup>  
DataFormat: Storage format of the binary waveform display data (Trace)<sup>\*2</sup>  
GroupNumber: The number of "\$Group"s indicated below  
TraceTotalNumber: Total number of target waveforms  
DataOffset: Start position of the binary waveform display data<sup>\*3</sup>

**\$Group1 (Group Information)**

TraceNumber: Number of waveforms in this group  
BlockNumber: Number of blocks in this group<sup>\*4</sup>  
TraceName: Name of each waveform  
BlockSize: Number of data points in a single block of each waveform  
VResolution: Value of coefficient VResolution of the Y-axis conversion equation of each waveform<sup>\*5</sup>  
VOffset: Value of coefficient VOffset of the Y-axis conversion equation of each waveform<sup>\*5</sup>  
VDataType: Type of binary waveform display data of each waveform<sup>\*6</sup>  
VUnit: Unit used on the Y-axis of each waveform (no effect on the data)  
VPlusOverData: Error data when the binary data of each waveform is greater than or equal to this value  
VMinusOverData: Error data when the binary data of each waveform is less than or equal to this value  
VMaxData: Maximum value of the binary data of each waveform  
VMinData: Minimum value of the binary data of each waveform  
HResolution: Value of coefficient HResolution of the X-axis conversion equation of each waveform  
HOffset: Value of coefficient HOffset of the X-axis conversion equation of each waveform  
HUnit: Unit used on the X-axis of each waveform (no effect on the data)  
Date: Date when the trigger occurred  
Time: Time when the trigger occurred

**\$PrivateInfo (Model-Specific Information)**

Mode: Two types available, Wave Normal and Wave Harmonics.  
ModelVersion: Version No. of the instrument

- \*1 Endian mode when saving data  
Big: Motorola 68000-family data
- \*2 Storage format of the binary waveform display data  
Trace: Format in which each block contains a waveform
- \*3 Start position of the binary waveform display data  
Offset from the beginning of the file. Always 4096 on the WT1600
- \*4 Maximum number of blocks in the group  
Maximum number of blocks when the number of blocks varies for each waveform. Always 1 on the WT1600.
- \*5 Conversion equation of the Y-axis of each waveform  
 $Y\text{-axis value} = V\text{Resolution} \times \text{raw data} + V\text{Offset}$
- \*6 Data type  
ISn: n-byte signed integer  
IUn: n-byte unsigned integer  
FSn: n-byte signed real number  
FUn: n-byte unsigned real number  
Bm: m-bit data

# Appendix 5 Power Basics (Power/Harmonics/Three Constants Related to the AC Circuit)

This section describes the basic concepts of power, harmonics, and the three constants related to the AC circuit.

## Power

Electrical energy is transformed and used in different forms such as heat in an electric heater or an electric furnace, rotational power to drive motors, and light in fluorescent and mercury lamps. Power (electric power) represents the amount of work that the electricity (electrical energy) performs on these types of loads over a unit amount of time. The unit of power is W (watts). When 1 joule of work is done over a period of 1 second, the electrical power is equal to 1 W.

### DC power

DC power  $P[W]$  can be determined by the product of the applied voltage  $U(V)$  and the current  $I[A]$ .

$$P = UI [W]$$

In the following figure, electrical energy indicated in the above equation is taken from the power source and dissipated at  $R[\Omega]$  (load).

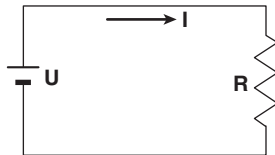

### AC (alternating current)

The electricity supplied by the power company is an alternating current. The waveform is sinusoidal. The amplitude of an AC signal can be expressed in terms of the instantaneous values, maximum values, rms values, and mean values. In general, it is expressed in terms of rms values.

The instantaneous value of the current of a sine wave,  $i$ , is expressed as  $I_m \sin \omega t$  ( $I_m$  : max. value of current,  $\omega$  : angular velocity where  $\omega = 2\pi f$ ,  $f$  : frequency of the AC signal). The heating effect of the AC signal is proportional to  $i^2$  and varies as shown in the following figure.

\* Refers to the electrical energy being converted to heat energy due to current flowing through the resistor.

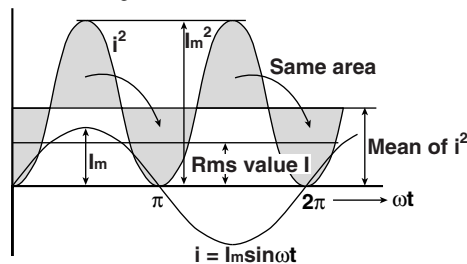

The rms value (effective value) is the value of the DC signal that generates the same heating effect as the AC signal. If the value of the DC signal that generates the same heating effect is expressed as  $I$ , then

$$I = \sqrt{\text{Mean over one period of } i^2} = \sqrt{\frac{1}{2\pi} \int_0^{2\pi} i^2 d\omega t} = \frac{I_m}{\sqrt{2}}$$

Because this value is equal to the square root of the mean of the square of the instantaneous values ( $i$ ) over one period (in short, rms), the symbol “rms” is generally used to denote the effective value.

## Appendix 5 Power Basics (Power/Harmonics/Three Constants Related to the AC Circuit)

---

For the mean value, since taking the average over one period of a sine wave results in zero, the mean is determined using the absolute value over one period of the signal. As with the rms value, if the mean value of the current of the instantaneous value  $i = I_m \sin \omega t$  is expressed as  $I_{mn}$ , then,

$$I_{mn} = \text{Mean over one period of } |i| = \frac{1}{2\pi} \int_0^{2\pi} |i| d\omega t = \frac{2}{\pi} I_m$$

This relationship is the same for the voltage of the sine wave.

The maximum value, rms value, and mean value of an AC sine wave are related in the following way. These values are used to calculate the crest factor and the form factor which are used to determine the trend of an AC signal.

$$\text{Crest factor} = \frac{\text{Maximum value}}{\text{Rms value}}$$

$$\text{Form factor} = \frac{\text{Rms value}}{\text{Mean value}}$$

**Vector Display of an AC signal**

In general, the instantaneous values of voltage and current are expressed by the following equations.

Voltage :  $u = U_m \sin \omega t$

Current :  $i = I_m \sin(\omega t - \phi)$

The time offset of the voltage and current is called the phase difference, and  $\phi$  is called the phase angle. This time offset is mainly created by the load that is supplied with power. In general, when there is only resistance in the load, the phase difference is zero; when there is inductance (coil) in the load, the current lags behind the voltage; when there is capacitance in the load, the current leads the voltage.

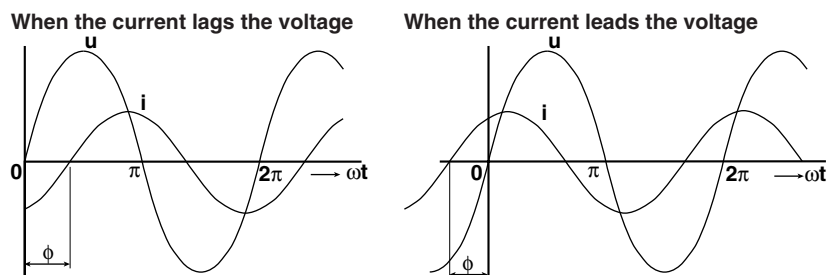

The vector display is used to show the amplitude and phase relationships of the voltage and current. Taking the positive vertical axis to be the reference, an angle in the counter clockwise direction is taken to be positive.

To clearly indicate that the graph is showing a vector, a dot is placed on the top of the symbol representing the value. The amplitude of the vector represents the rms value.

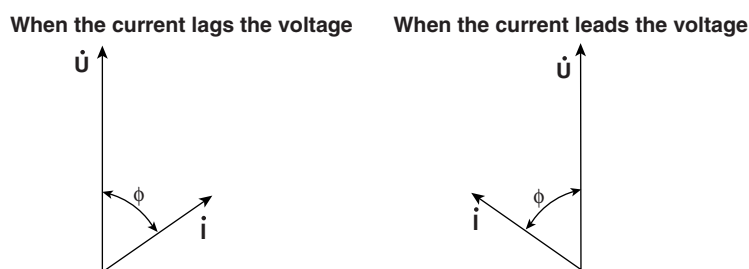

The vector display of the voltage and current of a three-phase AC signal would look something like the following figure.

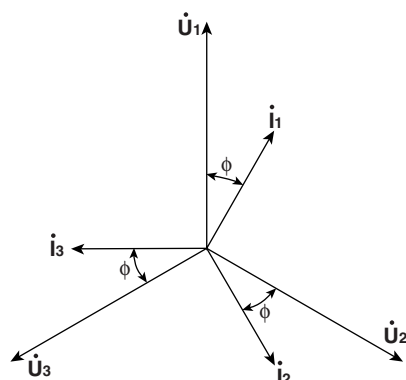

**AC power**

Because a phase difference depending on the load exists between the voltage and current, AC power is not as easily determined as DC power.

When the instantaneous voltage is  $u = U_m \sin \omega t$  and the instantaneous current is  $i = I_m \sin(\omega t - \phi)$ , the instantaneous power,  $p$ , is

$$p = u \times i = U_m \sin \omega t \times I_m \sin(\omega t - \phi) = UI \cos \phi - UI \cos(2\omega t - \phi)$$

where  $U$  and  $I$  represent the rms values of the voltage and current, respectively.

$p$  becomes the sum of the time-independent term, " $UI \cos \phi$ " and the AC component of twice the frequency of the voltage or current, " $-UI \cos(2\omega t - \phi)$ ."

The mean value of power over one period is called the AC power. Taking the mean over one period, the AC power,  $P$ , becomes

$$P = UI \cos \phi \text{ [W]}$$

The power varies depending on the phase difference,  $\phi$ , even when the voltage and current are the same. As shown in the figure below, the section above the horizontal axis represents positive power (power supplied to the load) and the section below the horizontal axis represents negative power (power delivered from the load). The difference between the two is the power dissipated by the load. As the phase difference between the voltage and current increases, negative power increases. At  $\phi = \pi/2$ , the positive and negative powers become equal and no power is dissipated in the load.

**When the phase difference between the voltage and current is 0**

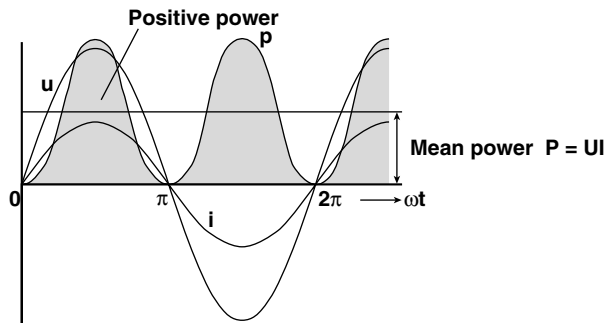

**When the phase difference between the voltage and current is  $\phi$**

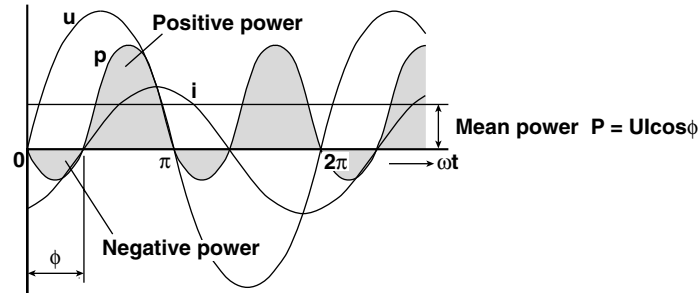

**When the phase difference between the voltage and current is  $\frac{\pi}{2}$**

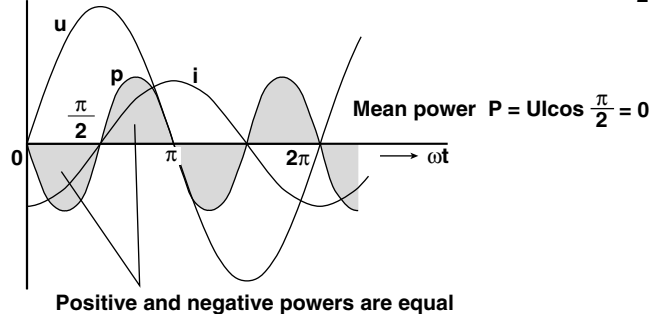

**Active power and the power factor**

Not all of the power represented by the product of the voltage and current,  $UI$ , is dissipated. The product,  $UI$ , is called the apparent power ( $S$ ). The unit is VA (volt-ampere). Apparent power is used to express the electrical capacity of the devices that run under AC power.

Of the apparent power, the true power that is dissipated by the device is called the active power or effective power ( $P$ ). This power is the same as the AC power described earlier.

$$S = UI \text{ [VA]}$$

$$P = UI\cos\phi \text{ [W]}$$

$\cos\phi$  represents the ratio of the true power with respect to the apparent power and this ratio is called the power factor ( $\lambda$ ).

**Reactive power**

When the current  $I$  lags the voltage  $U$  by  $\phi$ , the component of the power in the same direction as the voltage  $U$  is expressed as  $I\cos\phi$  and the component of the power perpendicular to the voltage  $U$  is expressed as  $I\sin\phi$ . The active power  $P=UI\cos\phi$  is the product of the voltage  $U$  and the current component  $I\cos\phi$ . Conversely, the product of the voltage  $U$  and the current component  $I\sin\phi$  is called reactive power ( $Q$ ) and its unit is var.

$$Q = UI\sin\phi \text{ [var]}$$

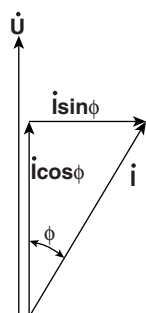

Apparent power  $S$ , active power  $P$ , and reactive power  $Q$  are related in the following way.

$$S^2 = P^2 + Q^2$$

## **Harmonics**

Harmonics are sine waves that have frequencies that are integer multiples of the frequency of a fundamental signal (generally a 50/60-Hz sinusoid in the field of power). The current power that flows through the power rectification circuit, phase control circuit, and other circuits that are used in various electrical devices, generates harmonic voltages and currents on the power line. When the fundamental signal and harmonic signals are combined, the waveform is distorted, and this can cause interference to devices that are connected to the power line.

### **Terminology**

The following terms are related to harmonics.

- **Fundamental wave (fundamental component)**  
Periodic complex waves are divided into different sinusoid groups. The fundamental wave is the signal with the longest period. It is the sinusoid that has the fundamental frequency among the periodic complex wave.
- **Fundamental frequency**  
This is the frequency corresponding to the period of the periodic complex wave. It is the frequency of the fundamental wave.
- **Distorted wave**  
The distorted wave has a waveform that is different from the fundamental wave.
- **Higher harmonic**  
Sinusoids that have frequencies that are integer multiples (2 or greater) of the fundamental frequency.
- **Harmonic component**  
The signal component of the waves that have frequencies that are integer multiples (2 or greater) of the fundamental frequency.
- **Harmonic distortion factor**  
The ratio of the rms value of the nth harmonic signal contained in the distorted waveform to the rms value of the fundamental signal or total signal.
- **Harmonic order**  
The integer ratio of the harmonic frequency with respect to the fundamental frequency.
- **Total harmonic distortion**  
The ratio of the rms value of all harmonics to the rms value of the fundamental signal or total signal.

### **Interference caused by harmonic signals**

Harmonic signals that adversely affect electric devices and facilities are as follows:

- **Phase advance capacitor or series reactor**  
The reduction of circuit impedance caused by the harmonic current causes excessive current to flow resulting in vibration, humming, overheating, and burnouts.
- **Cable**  
Overheating of the neutral conductor caused by harmonic currents flowing through it in a three-phase four-wire system.
- **Potential transformer**  
Causes magnetostrictive noise of the iron core which leads to increased iron and copper losses.
- **Breaker and fuse**  
Erroneous operation caused by excessive harmonic current. Causes fuse to blow.
- **Communication**  
Causes noise voltage from electro-magnetic induction.
- **Control device**  
Erroneous operation caused by distorted control signals.
- **Audio-visual equipment**  
Deterioration of performance and life span. Flicker caused by video noise. Malfunction of parts.

### Three Constants Related to the AC Circuit

#### Resistance

Current  $i$  when the instantaneous value of  $u = U_m \sin \omega t$  of AC voltage is applied to load resistor  $R[\Omega]$  is expressed by the following equation.  $I_m$  denotes the maximum value of the current.

$$i = \frac{U_m}{R} \sin \omega t = I_m \sin \omega t$$

If expressed in terms of the rms value, the equation becomes  $I = U / R$ .

The current flowing through a resistive circuit has no phase difference with respect to the voltage.

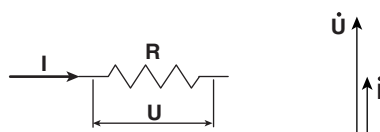

#### Inductance

Current  $i$  when the instantaneous value of  $u = U_m \sin \omega t$  of AC voltage is applied to the load inductance  $L[H]$  is expressed by the following equation.

$$i = \frac{U_m}{X_L} \sin \left( \omega t - \frac{\pi}{2} \right) = I_m \sin \left( \omega t - \frac{\pi}{2} \right)$$

If expressed in terms of the rms value, the equation becomes  $I = U / X_L$  where  $X_L = \omega L$ .  $X_L$  is called inductive reactance and its unit is  $\Omega$ .

Inductance has the effect of inhibiting the current from changing, and consequently the current phase lags that of the voltage.

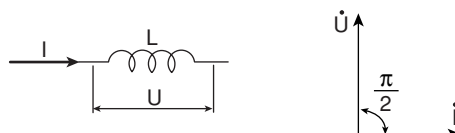

#### Static capacitance

Current  $i$  when the instantaneous value of  $u = U_m \sin \omega t$  of AC voltage is applied to the load capacitance  $C[F]$  is expressed by the following equation.

$$i = \frac{U_m}{X_C} \sin \left( \omega t + \frac{\pi}{2} \right) = I_m \sin \left( \omega t + \frac{\pi}{2} \right)$$

If expressed in terms of the rms value, the equation becomes  $I = U / X_C$ , where  $X_C = 1 / \omega C$ .  $X_C$  is called capacitive reactance and its unit is  $\Omega$ .

When the polarity of the voltage changes, the maximum charge current that has the same polarity as the voltage flows through the capacitor. When the voltage decreases, discharge current that has the opposite polarity as the voltage flows through the capacitor. Thus, the current phase advances with respect to the voltage.

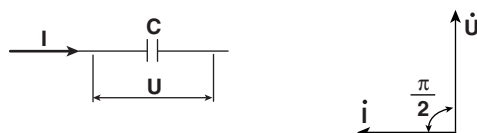



**R, L, C series circuit**

The voltage when resistance  $R_S[\Omega]$ , inductance  $L[H]$ , and static capacitance  $C[F]$  are connected in series is expressed by the following equation.

$$U = \sqrt{(U_{R_S})^2 + (U_L - U_C)^2} = \sqrt{(IR_S)^2 + (IX_L - IX_C)^2}$$

$$= I\sqrt{(R_S)^2 + (X_L - X_C)^2} = I\sqrt{R_S^2 + X_S^2}$$

$$I = \frac{U}{\sqrt{R_S^2 + X_S^2}}, \quad \phi = \tan^{-1} \frac{X_S}{R_S}$$

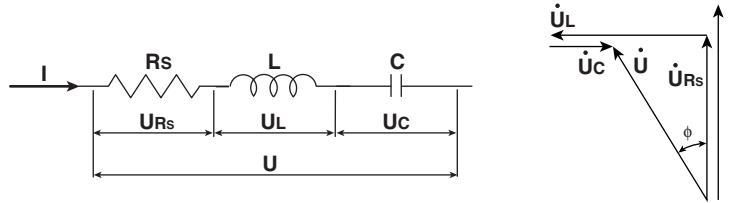

The relationships between resistance  $R_S$ , reactance  $X_S$ , and impedance  $Z$  are expressed as follows :

$$X_S = X_L - X_C$$

$$Z = \sqrt{R_S^2 + X_S^2}$$

**R, L, C parallel circuit**

The current when resistance  $R_P[\Omega]$ , inductance  $L[H]$ , and static capacitance  $C[F]$  are connected in parallel is expressed by the following equation.

$$I = \sqrt{(I_{R_P})^2 + (I_L - I_C)^2} = \sqrt{\left(\frac{U}{R_P}\right)^2 + \left(\frac{U}{X_L} - \frac{U}{X_C}\right)^2}$$

$$= U\sqrt{\left(\frac{1}{R_P}\right)^2 + \left(\frac{1}{X_L} - \frac{1}{X_C}\right)^2} = U\sqrt{\left(\frac{1}{R_P}\right)^2 + \left(\frac{1}{X_P}\right)^2}$$

$$U = \frac{IR_P X_P}{\sqrt{R_P^2 + X_P^2}}, \quad \phi = \tan^{-1} \frac{R_P}{X_P}$$

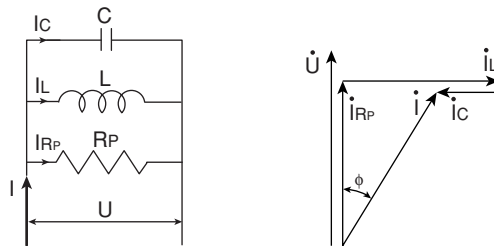

The relationship between resistance  $R_P$ , reactance  $X_P$ , and impedance  $Z$  are expressed as follows :

$$X_P = \frac{X_L X_C}{X_C - X_L}$$

$$Z = \frac{R_P X_P}{\sqrt{R_P^2 + X_P^2}}$$

# Index

## Symbols

(I) Position .....	9-9
(I) V Zoom .....	9-9
(U) Position .....	9-9
(U) V Zoom .....	9-9
1/Fundamental .....	7-13
1/Total .....	7-13
180 Lead/Lag .....	6-18
180dpi .....	13-13
2048 .....	7-14
3-month accuracy .....	17-7
360 degrees .....	6-18
360dpi .....	13-13

## A

abort .....	11-15, 12-15, 12-24, 13-13
AC circuit, three constants .....	App-23
AC power .....	App-20
AC signal, vector display of .....	App-19
accessories, optional .....	v
accessories, standard .....	iv
accuracy .....	17-7
active power .....	App-21
aliasing .....	1-24
All .....	4-7
All Reset .....	12-30, 12-33
All Set .....	12-30, 12-33
ambient humidity .....	3-2
ambient temperature .....	3-2
angular velocity .....	App-17
apparent power .....	App-21
apparent power, equation for .....	1-18, 6-15
ASCII .....	12-16, 12-17
attenuation constant .....	5-19
attribute .....	12-27
Auto Cal .....	6-30
auto naming .....	12-14
auto naming function .....	11-18, 12-19
auto range .....	1-10
auto scaling .....	10-13
average count .....	5-19
averaging .....	1-12, 5-19
averaging type, selection of .....	5-19
AVG .....	5-19
Avg Type .....	5-19

## B

Bar .....	4-12
Bar C1 + .....	7-21
bar cursor .....	7-21
bar graph .....	1-29, 4-12
bar graphs, print format of .....	14-11
Bar Item No. ....	7-20
binary .....	12-12, 12-16
block diagram .....	1-2
BMP .....	12-22

## C

CAL .....	15-12
circuit with voltage input exceeding 600 V .....	3-19
clear .....	11-10, 11-18
color .....	12-21, 13-13
color output .....	13-13, 13-14
comment .....	11-14, 11-18, 12-14, 12-18, 13-13, 14-5
Config .....	15-14
Connect Log List .....	13-21
Continuous .....	6-20
Convert Memory .....	11-14
Convert Memory Exec .....	11-15
copy .....	12-32, 13-13
copy destination .....	12-34
copy source .....	12-33
Copy to .....	12-20, 13-12, 14-2, 14-5, 14-7
corrected power .....	1-18
corrected power, equation of .....	6-16
count .....	5-19
crest factor .....	5-29, 17-10, App-18
CT ratio .....	5-15
CT ratio, setting of .....	5-15
current, determination of .....	1-4
current input terminal .....	2-1
current input terminal, construction of .....	ii
current mode .....	6-29, 6-30
current range, list of .....	5-8
current range, setting of .....	5-5
current sensor input connector .....	2-1, 5-10
current sensor input connector, connection to .....	3-12
current sensor range, copying of .....	5-11
current sensor range, setting of .....	5-10
current sensor transformation ratio, copying of .....	5-12
current sensor transformation ratio, setting of .....	5-11
cursor .....	7-21, 9-21, 10-14
cursor measurements .....	1-28, 9-21, 10-14
cursor path .....	9-22

## D

D/A output .....	1-33
D/A output connector .....	2-1
D/A output connector, pin arrangement of .....	15-5
D/A output items .....	15-1, 15-5
D/A Output Rated Time .....	15-4
D/A output voltage .....	15-7
data compression .....	12-21
data length .....	17-12
data points .....	1-24
data size .....	11-17, 12-16, 12-17, 12-22
data type .....	11-14, 11-17, 12-12, 12-13, 12-16, 12-17
data update interval .....	1-8
data update rate .....	1-13, 5-22
date/time .....	3-22, 3-23
default gateway .....	13-3, 13-6
delete .....	12-26, 12-29
Delete Exec .....	12-30
delta computation .....	1-18, 6-12
delta computation, determination of .....	App-6
DMeasure .....	6-12
DHCP .....	13-3
directory .....	11-18

## Index

directory, creation of ..... 12-39  
directory, renaming of ..... 12-39  
directory, selection of ..... 12-18  
disk, formatting of ..... 12-6, 12-9  
display ..... 4-1  
display colors ..... 1-34  
display format ..... 4-7, 4-8, 4-11, 4-13, 4-16  
display interpolation ..... 1-27, 9-16  
display resolution ..... 1-14  
display segments ..... 1-24  
displayed items, number of ..... 4-7, 4-8  
distorted wave ..... App-22  
distortion factor, equation for ..... 1-19  
DNS ..... 13-3, 13-6  
DNS server address ..... 13-6  
domain name ..... 13-4, 13-6  
domain suffix ..... 13-6  
dual list ..... 1-17, 4-9, 7-4

## E

efficiency ..... 1-4  
element ..... 1-4, 1-7, 2-1, 6-2, 7-3, 7-4, 7-20, 10-3, 10-4, 15-2, 15-3  
Element Object ..... 5-4, 5-10, 5-11, 5-14, 5-17, 6-4, 9-8  
element, selection of ..... 5-4, 5-10, 5-14, 5-17, 6-4  
End Order ..... 7-20  
equation ..... 6-9, 6-10, 7-16, 7-17  
error messages ..... 16-2  
ESC-P ..... 13-12  
Ethernet ..... 1-32, 13-1  
Ethernet connector ..... 2-1  
Ethernet interface ..... 13-2  
expendable items ..... 16-10  
Ext Clk ..... 7-9  
extension ..... 12-16, 12-17, 12-22  
extensions of numerical data ..... 11-17  
external clock input connector ..... 2-1  
external dimensions ..... 17-19, 17-21  
external start/stop signal  
input/output connector ..... 2-1

## F

FFT processing word length ..... 17-12  
file ..... 12-6, 12-11, 12-20, 12-23, 12-26, 12-29, 12-32, 12-36  
file attributes ..... 12-27, 12-28  
File Item ..... 12-11, 12-23  
file list ..... 11-14, 12-20  
File List dialog box ..... 11-18  
file name ..... 11-14, 11-18, 12-14, 12-18  
file properties ..... 12-26  
files, copying of ..... 12-32  
files, deleting of ..... 12-29  
files, renaming of ..... 12-39  
filter ..... 5-17, 11-15, 12-27  
Filter Copy Exec ..... 5-18  
float ..... 12-12, 12-16, 12-17  
floppy disk drive ..... 12-1  
floppy disk, formatting of ..... 12-9  
form factor ..... App-18  
format ..... 4-1, 12-6, 12-7, 12-8, 12-21, 13-12  
Format Exec ..... 12-8  
format type ..... 12-8  
Freq Item ..... 6-7  
frequency measurement target ..... 6-7  
front panel ..... 2-1

FTP client function ..... 1-32  
FTP passive ..... 13-25  
FTP server ..... 13-9  
FTP server function ..... 1-33  
function ..... 6-2, 7-3, 7-4, 7-20, 10-3, 10-4, 12-6, 12-26, 12-29, 12-32, 12-36, 15-2, 15-3  
fundamental frequency ..... App-22  
fundamental wave ..... App-22  
fuse rating ..... 16-9

## G

GP-IB ..... 1-33  
graph color ..... 15-16  
graphic color ..... 15-16, 15-18  
graticule ..... 1-27, 9-17

## H

hard disk, formatting of ..... 12-9  
Harm Item No. .... 7-3, 15-3  
Harmonic component ..... App-22  
harmonic distortion factor ..... App-22  
Harmonic order ..... App-22  
harmonics ..... 7-1, 7-7, 7-8, 7-11, 7-13, 7-14  
HDD Motor ..... 12-2  
higher harmonic ..... App-22  
hold ..... 1-13, 5-24  
horizontal axis ..... 1-23, 10-11  
humidity (ambient) ..... 3-2

## I

I Range Down Exec ..... 5-5, 5-10  
I Range Up Exec ..... 5-5, 5-10  
independent control ..... 6-20, 6-23  
inductance ..... App-23  
information ..... 4-17, 13-23, 14-7, 16-8  
initial settings ..... App-8  
initialization ..... 1-33, 15-10  
Initialize Memory Exec ..... 11-10  
Initialize SCSI ..... 12-4  
Initialize Settings ..... 15-10  
input filter ..... 1-11, 5-17, 5-18  
input filter, copying of ..... 5-18  
input terminal, connection to ..... 3-9, 3-16  
installation conditions ..... 3-2  
installation position ..... 3-3  
instantaneous value ..... App-17  
Instrument No. .... iii  
insulation resistance ..... 17-19  
INTEG SET ..... 6-20, 6-23, 6-29, 15-4  
Integ Sync ..... 11-1  
integrated D/A output, rated time of ..... 15-7  
Integration, Allowable Frequency Range ..... 6-35  
integration auto calibration ..... 6-30  
integration, holding of ..... 6-31  
integration mode ..... 1-20  
integration overflow ..... 6-35  
integration, resetting of ..... 6-31  
integration, resolution of ..... 6-35  
integration, starting of ..... 6-31  
integration, stopping of ..... 6-31  
integration timer ..... 6-22, 6-27  
internal memory, initialization of ..... 11-10, 11-18  
interpolate ..... 9-16

interval ..... 13-17  
 Interval Setting ..... 11-3  
 IP address ..... 13-3, 13-5  
 Item Amount ..... 4-2, 4-4  
 Item Copy Exec ..... 6-5  
 Item Down Exec ..... 6-4  
 Item Up Exec ..... 6-4  
 items not covered by warranty ..... 16-10

**J**

jog shuttle ..... 2-3

**K**

key lock ..... 15-19  
 keyboard ..... 16-6  
 keyboard, testing of ..... 16-7  
 keys ..... 2-3  
 keys, testing of ..... 16-7

**L**

labels ..... 1-28, 9-19  
 line filter ..... 5-17, 8-6  
 line filter, selection of ..... 5-17  
 list display ..... 1-16, 4-8  
 list item ..... 7-4, 11-7, 12-13, 14-8  
 List Item No. .... 7-4  
 load ..... 1-32, 12-24  
 Load Exec ..... 12-24  
 logging list ..... 13-21  
 logical format ..... 12-10  
 login name ..... 13-9, 13-10  
 lower limit ..... 10-13  
 Lower Scale ..... 10-13  
 LPR client function ..... 1-33  
 LPR Name ..... 13-12  
 LPR Server ..... 13-12  
 LPR Time Out ..... 13-25

**M**

MAC address ..... 13-23  
 mail address ..... 13-16  
 mail server ..... 13-16, 13-17  
 mail setup ..... 13-15  
 mail test ..... 13-17  
 mail, transmission of ..... 13-15  
 MailBaseTime ..... 13-16  
 manual ..... 11-1  
 manual scaling ..... 10-13  
 master ..... 5-26  
 master/slave synchronized measurement ..... 1-13  
 Max ..... 9-22  
 MAX hold ..... 1-13, 5-25  
 maximum harmonic order to be analyzed ..... 7-11  
 maximum output current ..... 17-13  
 maximum power consumption ..... 17-19  
 maximum value ..... App-17  
 mean value ..... App-18  
 measure ..... 5-26, 6-7, 6-12, 6-15, 6-18, 7-15  
 measurement function symbols, meanings of ..... 4-6, 4-8  
 measurement function types (harmonic measurement) ..... 1-5  
 measurement function types (motor evaluation funct ..... 1-7  
 measurement function types (normal measurement) ..... 1-3  
 measurement functions (of integration) ..... 1-20

measurement functions, determination of ..... App-1  
 measurement functions, symbols of ..... App-1  
 measurement method ..... 17-10  
 measurement period ..... 1-8  
 measurement range ..... 1-10, 5-4  
 media ..... 11-14, 11-18  
 media information ..... 12-7, 12-9  
 medium, selection of ..... 12-18  
 memory ..... 16-6  
 memory test ..... 16-7  
 menu ..... 12-20, 13-12, 14-2, 14-5, 14-7  
 message ..... 15-14  
 message language ..... 1-34, 15-14  
 Mid ..... 9-22  
 Min Order ..... 7-11  
 minimum harmonic order to be analyzed ..... 7-11  
 MISC 12-2, 12-4, 13-2, 13-8, 13-11, 13-15, 13-19, 13-23,  
 13-24, 15-1, 15-10, 15-14, 15-16, 16-6, 16-8  
 mode ..... 6-20, 6-23, 7-1, 11-1  
 MODEL ..... ii  
 motor efficiency ..... 8-16  
 MOTOR SET ..... 8-3, 8-6, 8-7, 8-10, 8-12, 8-14

**N**

Net Drive Setup ..... 13-8  
 Net Print ..... 13-12  
 Net Print Setup ..... 13-11  
 network ..... 13-2, 13-8, 13-11, 13-15, 13-19, 13-24  
 network connection ..... 13-1  
 network printer ..... 13-12  
 NO. .... iii  
 normal ..... 6-20  
 normal integration mode ..... 6-22  
 NULL ..... 15-13  
 NULL function ..... 1-34  
 numeric ..... 4-1, 7-23, 11-6, 12-11  
 Numeric Disp Items ..... 6-2, 7-3  
 Numeric+Wave ..... 11-6  
 numerical data, display order of ..... App-12  
 numerical data list, printing of ..... 14-10  
 numerical data, saving of ..... 12-17  
 numerical display (harmonic measurement) ..... 1-15  
 numerical display (normal measurement) ..... 1-14

**O**

object ..... 7-7  
 one year accuracy ..... 17-8  
 one-to-one connection ..... 13-1  
 operating altitude ..... 17-19  
 operating conditions ..... 17-19  
 operation keys ..... 2-3  
 operators ..... 6-11, 7-18  
 options ..... iii  
 order ..... 7-3, 10-4, 15-3  
 others ..... 13-24  
 output command ..... 13-12, 13-14  
 Own ID ..... 12-4

**P**

P-P compression ..... 1-24  
 package, contents of ..... ii  
 paper feed ..... 14-2  
 partitions ..... 12-8, 12-10  
 password ..... 13-9, 13-10, 13-20, 13-21

## Index

pattern ..... 5-1  
phase ..... 6-18  
phase angle ..... App-19  
phase difference ..... 1-19  
physical format ..... 12-10  
pin arrangement ..... 15-5, 15-9  
PLL source ..... 1-7  
PLL Source Down Exec ..... 7-8  
PLL Source Up Exec ..... 7-8  
Pm, scaling of ..... 8-14  
pole ..... 8-12  
PostScript ..... 12-21, 12-22, 13-12  
power ..... App-17  
power coefficient, setting of ..... 5-15  
power connector ..... 2-1  
power cord ..... iii  
power factor ..... App-21  
power fuse ..... 2-1, 16-9  
power loss ..... 3-6  
power, mean value of ..... App-20  
power range ..... 1-10  
power supply ..... 3-8  
power switch, turning ON/OFF of ..... 3-20  
precautions, use of the instrument ..... 3-1  
Preset1 ..... 11-7, 12-13, 14-8  
Preset2 ..... 11-7, 12-13, 14-8  
primary ..... 13-4  
print ..... 1-32  
printer ..... 14-2, 14-5, 14-7  
printer cover ..... 14-1  
printer name ..... 13-12, 13-14  
printer roll paper ..... 14-4  
printer server ..... 13-12, 13-14  
properties ..... 11-15, 11-19, 12-27, 12-28  
protective earth ground ..... 3-8  
PT ratio ..... 5-14  
PT ratio, setting of ..... 5-14  
pulse input range, setting of ..... 8-4  
Pulse N ..... 8-8  
Pulse Range ..... 8-4  
push ..... 14-1

## Q

Quad ..... 9-13, 10-8

## R

R ..... 12-28  
R-Continuous ..... 6-23  
R-Normal ..... 6-23  
R/W ..... 12-28  
rack mount ..... 3-3  
range ..... 5-4, 5-10  
Range Copy Exec ..... 5-5, 5-11  
range, copying of ..... 5-5  
rasters ..... 1-24  
rated supply voltage ..... 17-19  
rated supply voltage frequency ..... 17-19  
reactive power ..... App-21  
real-time ..... 11-2, 11-4  
real-time control ..... 6-24, 11-4  
real-time normal integration mode ..... 6-27  
real-time repetitive integration mode ..... 6-27  
rear panel ..... 2-1  
recall ..... 1-32, 11-20  
Recall No. .... 11-20

recipient mail address ..... 13-17  
release lever ..... 14-1  
repetitive integration mode ..... 6-22, 6-27  
reservation time ..... 6-28  
Reset List Exec ..... 6-2  
resistance ..... App-23  
resolution ..... 13-13  
response time ..... 17-10  
Restart Trend Exec ..... 10-18  
revolution signal input connector ..... 2-1, 8-1  
revolution signal, input range of ..... 8-3  
revolution signal type, selection of ..... 8-4  
RGB video signal ..... 1-33, 15-9  
RGB video signal (VGA) output connector ..... 2-1  
rms ..... App-17  
rms value ..... App-17  
roll paper ..... 14-4

## S

S Formula ..... 6-15  
sample rate ..... 17-12, 17-14  
sampling frequency ..... 17-12  
save ..... 1-32, 12-12  
Save Exec ..... 12-15  
saved items ..... 12-11  
scale values ..... 1-27, 9-19  
scaling ..... 1-11, 5-11, 5-14, 10-13  
Scaling Copy Exec ..... 5-12, 5-15  
scaling factor ..... 5-15  
scaling function, operation of ..... 5-14  
screen brightness ..... 1-34, 15-14  
screen image data, saving of ..... 12-22  
SCSI ..... 12-3  
SCSI connector ..... 2-1  
SCSI ID ..... 12-4  
SCSI setting ..... 12-2, 12-4  
secondary ..... 13-4  
self-test ..... 1-34, 16-6  
Sense Type ..... 8-4  
Sensor Ratio(mV/A) ..... 5-11  
serial ..... 1-33  
Set/Reset ..... 12-30, 12-33  
setup ..... 12-11, 12-23  
setup parameters, listing of ..... 4-17  
setup parameters, saving of ..... 12-16  
S functions (during harmonic measurement) ..... 1-3  
S functions (during normal measurement) ..... 1-6  
S list ..... 1-17, 4-9  
signal assignment ..... 15-5, 15-9  
signal flow and process ..... 1-2  
single ..... 5-24, 9-13, 10-8  
single list ..... 1-16, 4-9, 7-4  
single measurement ..... 1-13, 5-24  
slave ..... 5-26  
Smp Clk ..... 7-9  
SMTP Time Out ..... 13-25  
SMTP timeout time ..... 13-25  
soft key ..... 16-7  
spare fuse ..... 16-9  
spare parts ..... v  
speed ..... 8-1, 8-3  
speed, scaling of ..... 8-7  
split screen ..... 1-27  
split windows, number of ..... 9-13  
standard accessories ..... iv  
Start Order ..... 7-20

static capacitance ..... App-23  
storage environment ..... 17-19  
storage location ..... 3-2  
store ..... 11-11  
store count ..... 11-3  
store interval ..... 11-3  
Store Item ..... 11-6  
store item, selection of ..... 11-6  
store mode ..... 11-1  
store operation, automatically stopping of ..... 11-11  
store operation, starting of ..... 11-11  
store operation, stopping of ..... 11-11  
store reservation time ..... 11-4  
STORE SET ..... 11-1, 11-3, 11-6, 11-10, 11-13, 11-20  
Store Setting ..... 11-1, 11-3, 11-6  
Store to ..... 11-10, 11-13  
stored data, saving of ..... 11-13  
storing ..... 1-32  
stray capacitance ..... 3-7  
strings, entry of ..... 3-24  
subnet mask ..... 13-3, 13-6  
SUFFIX ..... ii  
symbols ..... vi  
Sync Measure ..... 5-26  
sync source ..... 6-4, 8-4  
Sync Speed ..... 8-13  
synchronization source ..... 1-8  
synchronization source, copying of ..... 6-5  
synchronization source, selection of ..... 8-4  
synchronization source, setting of ..... 6-4  
synchronized measurement ..... 1-13, 5-26  
system condition ..... 1-34, 16-8  
system configuration ..... 1-1

## T

TCP/IP ..... 13-2  
TCP/IP Setup ..... 13-2  
temperature (ambient) ..... 3-2  
temperature coefficient ..... 17-8, 17-13  
terminal ..... 5-5, 5-10  
Test Exec ..... 16-7  
Test Item ..... 16-6  
test transmission ..... 13-17  
text color ..... 15-17, 15-18  
Thd Formula ..... 7-13  
TIFF ..... 12-21, 12-22  
time ..... 3-23  
time axis ..... 1-23, 10-10  
time axis, setting of ..... 9-2  
time lag ..... 16-9  
timeout ..... 13-20  
timeout time ..... 13-9, 13-10, 13-20, 13-21  
timer accuracy ..... 17-11  
timer setting ..... 6-21, 6-24  
top view ..... 2-2  
torque ..... 8-2, 8-4  
torque meter signal input connector ..... 2-1, 8-2  
torque, scaling of ..... 8-10  
torque signal, input range of ..... 8-4  
total efficiency ..... 8-16  
total harmonic distortion ..... App-22  
trace ..... 12-12  
trace label ..... 9-19  
transmission interval ..... 13-17  
transmission, time of ..... 13-16, 13-17  
trend ..... 1-31, 4-15

Trend C1 + ..... 10-15  
trend cursor ..... 10-14  
trend data, retrieval of ..... 10-1  
Trend Disp Items ..... 10-2  
trend display ..... 10-7  
trend format ..... 10-8  
trend object ..... 10-4, 10-13  
trend sampling ..... 10-1  
trend scale ..... 10-12  
trend setting ..... 10-1, 10-2, 10-6, 10-8, 10-10, 10-12, 10-18  
TrendC1 Trace ..... 10-15  
TrendC2 Trace ..... 10-15  
trigger ..... 9-4  
trigger level ..... 1-25, 9-5  
trigger mode ..... 1-25, 9-5  
trigger slope ..... 1-25, 9-5  
trigger source ..... 1-25, 9-5

## U

U Range Down Exec ..... 5-4  
U Range Up Exec ..... 5-4  
Umean\*Irms ..... 6-15  
update rate ..... 5-22  
Update Rate Down Exec ..... 5-22  
Update Rate Up Exec ..... 5-22  
upper limit ..... 10-13  
upper limit of harmonic order under analysis ..... 17-12  
Upper Scale ..... 10-13  
Urms\*Irms ..... 6-15  
user account ..... 13-19  
user defined ..... 7-15  
user name ..... 13-20, 13-21  
user-defined function ..... 1-18, 6-8  
utility ..... 12-6, 12-26, 12-29, 12-32, 12-36

## V

V Zoom & Position ..... 9-8  
values, entry of ..... 3-24  
vectors ..... 1-29, 4-14  
vertical axis ..... 1-23  
vertical position ..... 1-26  
VGA ..... 1-33, 15-9  
video signal output connector, pin arrangement of ..... 15-9  
voltage, determination of ..... 1-4  
voltage input terminal ..... 2-1  
voltage range, setting of ..... 5-4

## W

warm-up time ..... 17-19  
wave ..... 4-10, 9-1, 9-2, 9-4, 9-8  
Wave C1 + ..... 9-22  
wave cursor ..... 9-21  
wave display ..... 9-12  
wave format ..... 9-13  
wave mapping ..... 9-14  
wave sampling ..... 9-1  
wave setting ..... 9-11, 9-13, 9-16, 9-19  
wave trace ..... 11-8  
WaveC1 Trace ..... 9-22  
WaveC2 Trace ..... 9-22  
waveform display data, extension of ..... 11-17  
waveform display data, retrieval of ..... 1-24, 9-1  
waveform display data, saving of ..... 12-16  
waveform mapping ..... 1-27, 9-14, 10-9

## Index

---

waveform, zooming of .....	1-26
waveforms .....	4-10
weight .....	17-19
window function .....	17-12
window width .....	7-14, 17-12
windows, number of .....	9-13
wiring .....	5-1
wiring example (current sensor) .....	3-14
wiring example (direct wiring) .....	3-10
wiring example (PT and CT) .....	3-17
wiring precautions .....	3-4
wiring system .....	1-4, 1-7, 1-9, 5-2
wiring system pattern .....	1-9, 5-1
withstand voltage .....	17-19
WT1600 .....	ii

## Z

---

zero crossing filter .....	5-17
zero crossing filter, selection of .....	5-17
zero-level compensation .....	1-34, 15-12
zoom .....	1-26
zoom (vectors) .....	7-24